

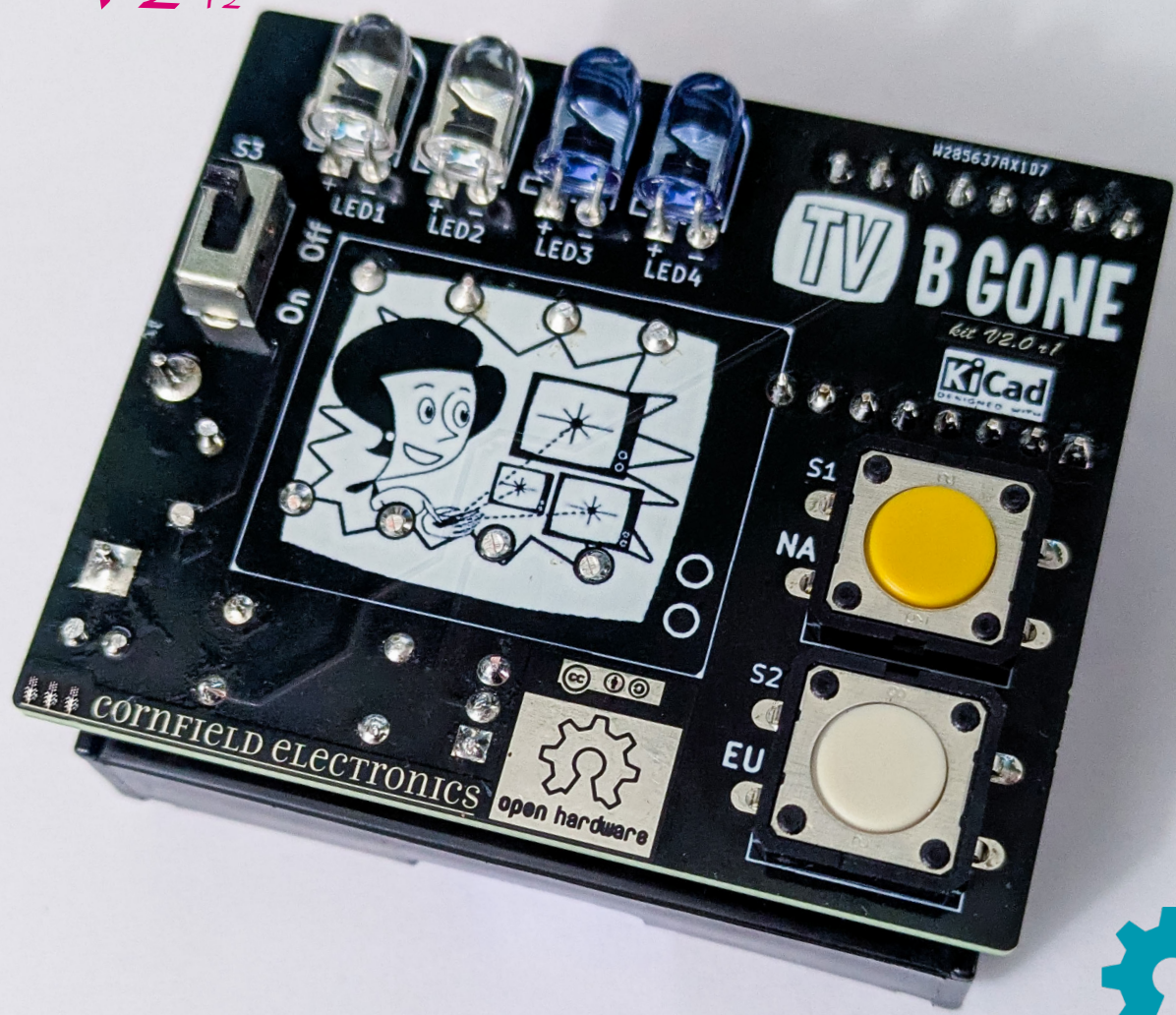

Kit

V2 r2



Turn off TVs in public places from 50 meters away!



Learn To Solder



download for free at:
<http://mightyohm.com/soldercomic>
(In many different languages.)

Learn To Solder

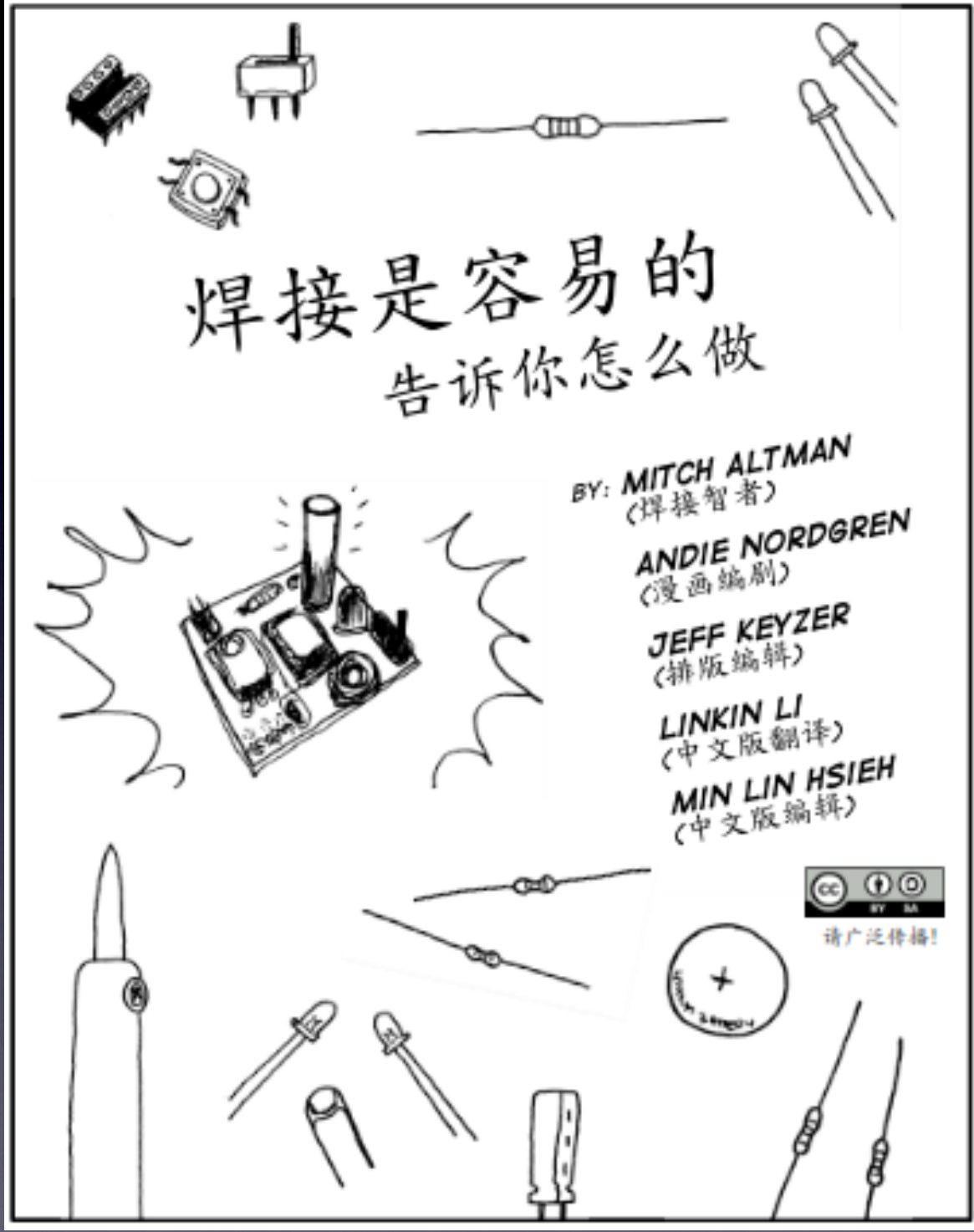

download for free at:
<http://mightyohm.com/soldercomic>
(In many different languages.)

Learn To Solder



SOLDAR ES FÁCIL!

APRENDE CÓMO HACERLO

POR: MITCH ALTMAN
(SABIDURÍA EN SOLDADO)

ANDIE NORDGREN
(ADAPTACIÓN A COMIC)

JEFF KEYZER
(DISEÑO Y EDICIÓN)



DISTRIBUYE AMPLIAMENTE!

download for free at:
<http://mightyohm.com/soldercomic>
(In many different languages.)

Learn To Solder



LÖTEN IST EINFACH SO WIRD ES GEMACHT

VON: MITCH ALTMAN
(LÖTWEISHEITEN)
ANDIE NORDGREN
(KOMIK-UMSETZUNG)
JEFF KEYZER
(LAYOUT UND BEARBEITUNG)
ALEXANDER BODORA
(ÜBERSETZUNG UND BEARBEITUNG)
RICHARD MEINSEN
(ÜBERARBEITUNG UND KORREKTUR)



WEITER
VERTEILEN!

download for free at:
<http://mightyohm.com/soldercomic>
(In many different languages.)

Parts

NOTE: The board has a place for U1, but it is not included

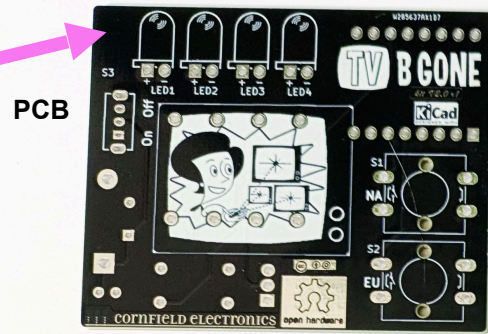

Double-sided tape
(to attach
Battery Pack
to
project)
↓

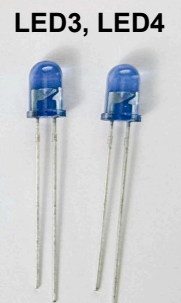
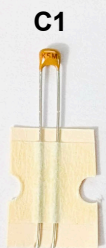
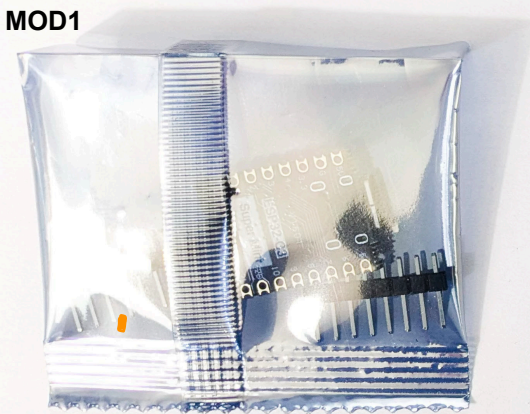
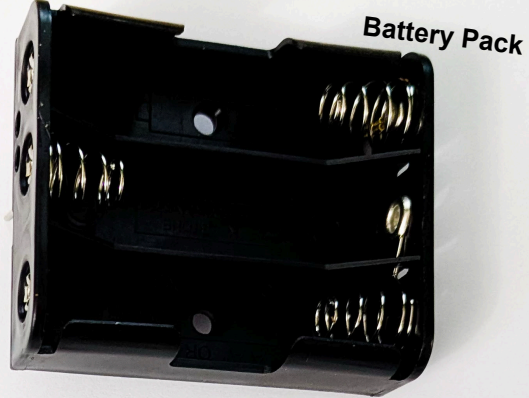

R1-R4 (1.0) Brown, Black, Gold, Gold

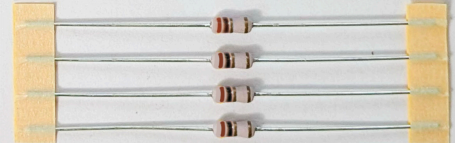

R5 (56) Green, Blue, Black, Gold



R6 (47K) Yellow, Violet, Orange, Gold



All of the parts

Board (PCB)

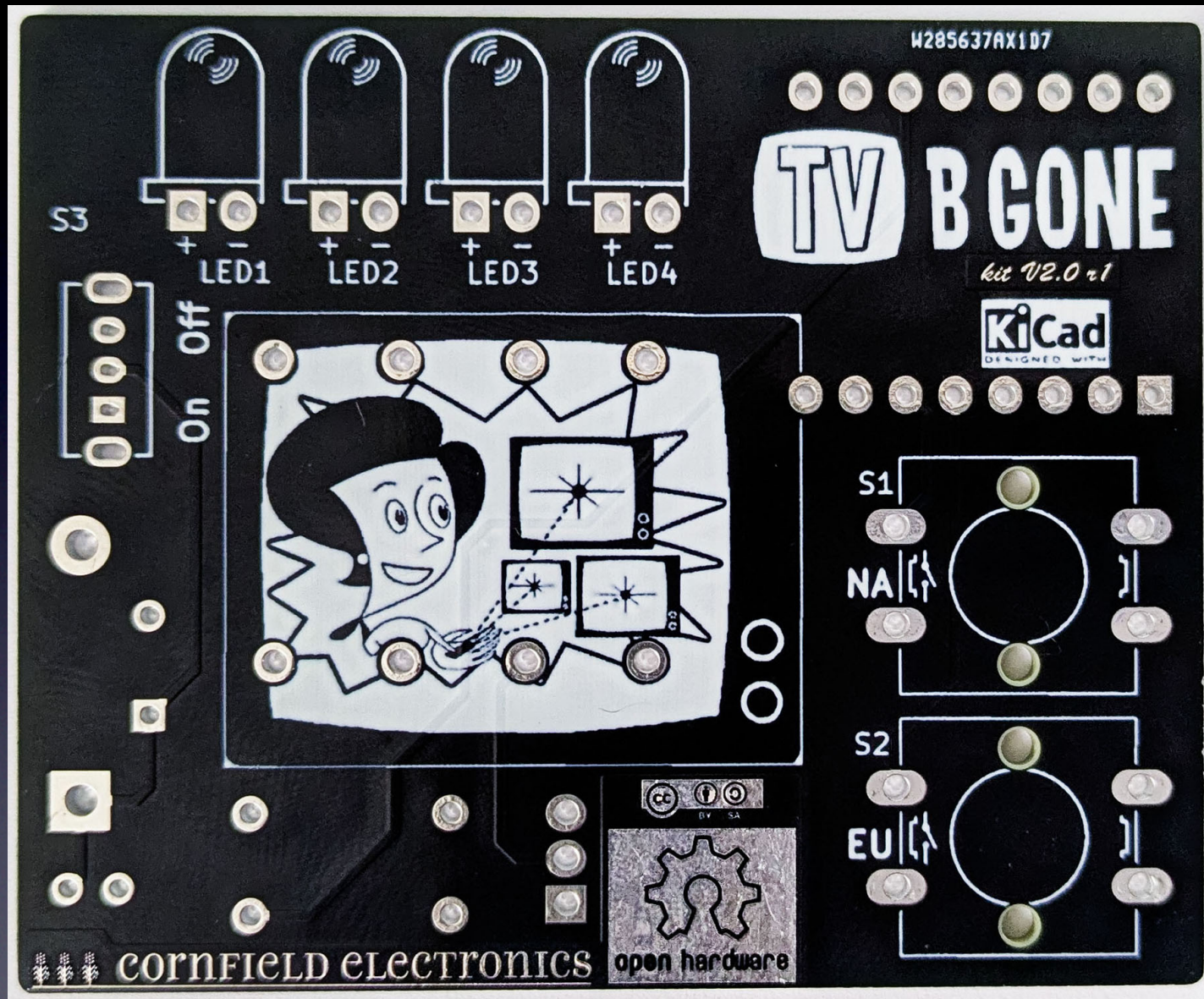

The Front

Board (PCB)

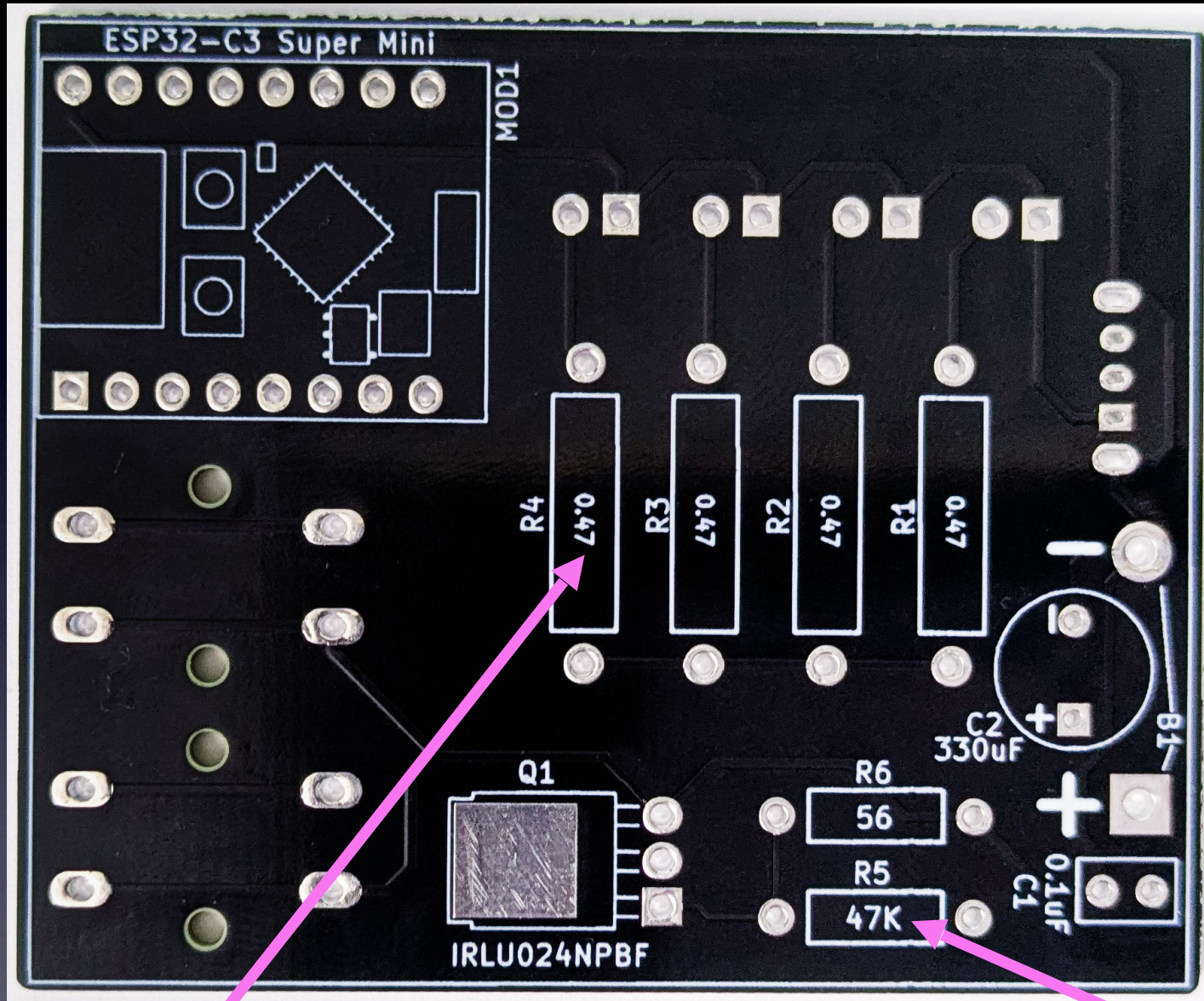

NOTE:

The Back

NOTE — labeling:

R5 now say correctly says 56

R6 now correctly says 47K

R1-R4 now correctly say 1.0

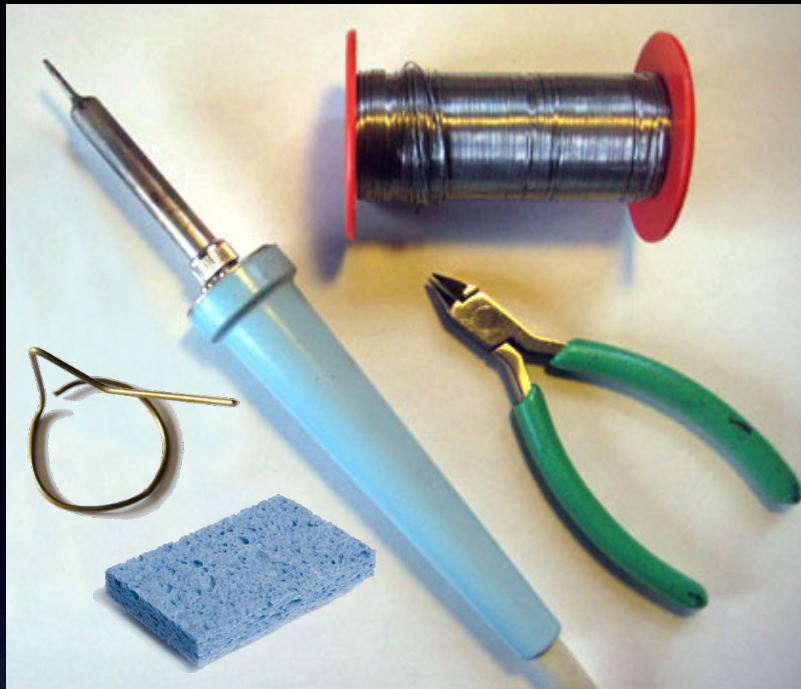

Note:

If you use
Lead-Free solder
it is helpful
to also have
flux paste in a syringe
and Isopropyl Alcohol



The tools you'll need:

- soldering Iron (35W or less)
- solder (*more details coming*)
- soldering iron stand
- cellulose kitchen sponge (*not plastic!*)
- *small* wire cutter

Look at the shape of these parts

R1 - R4

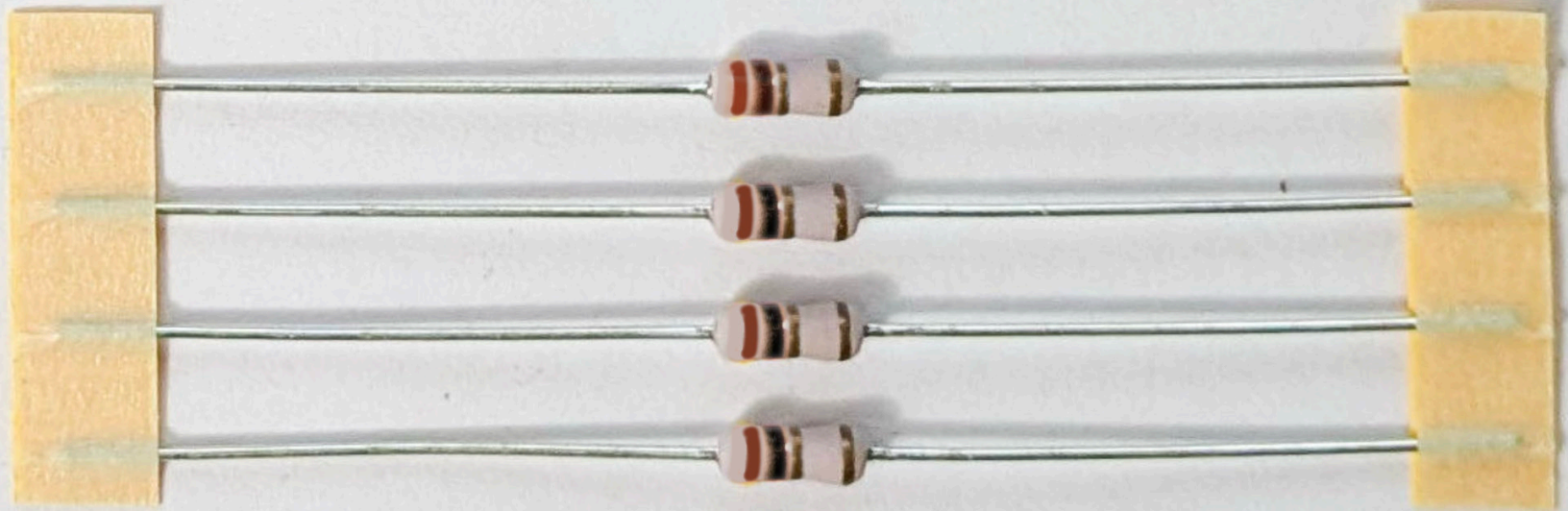

See similar shapes on the PCB

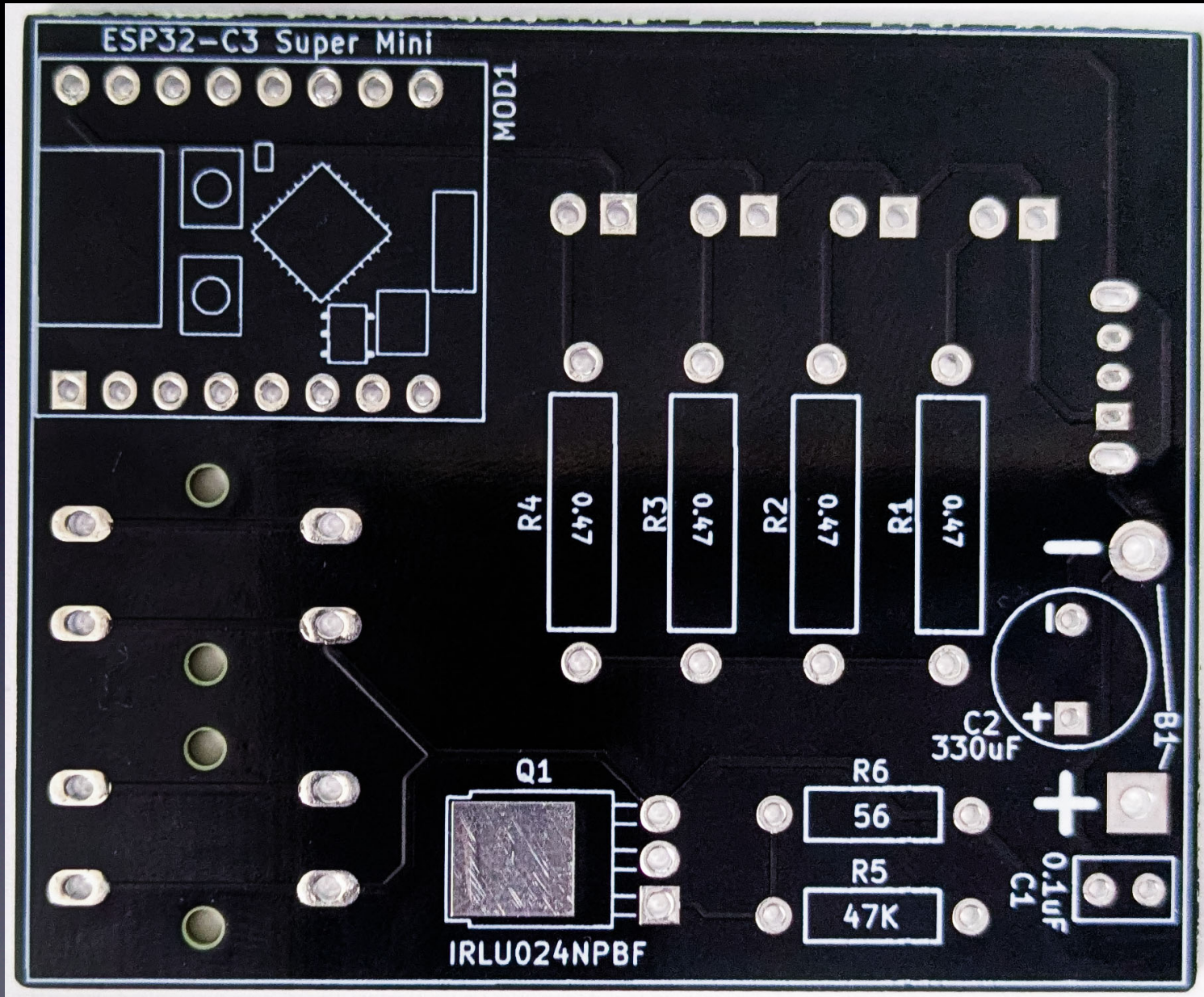

We will start with Resistor R1

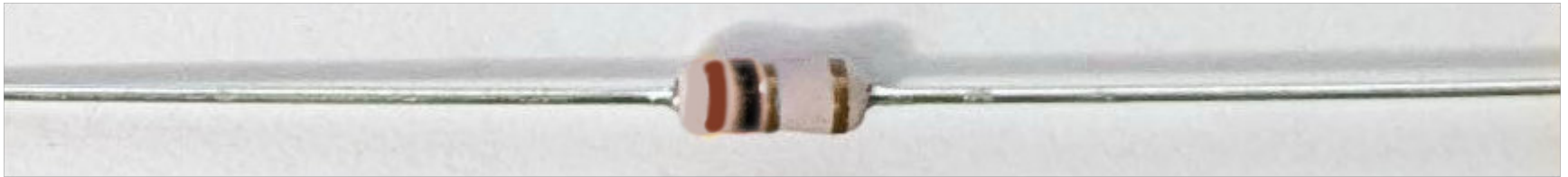

R1-R4 (1.0) Brown, Black, Gold, Gold

Pull tape off

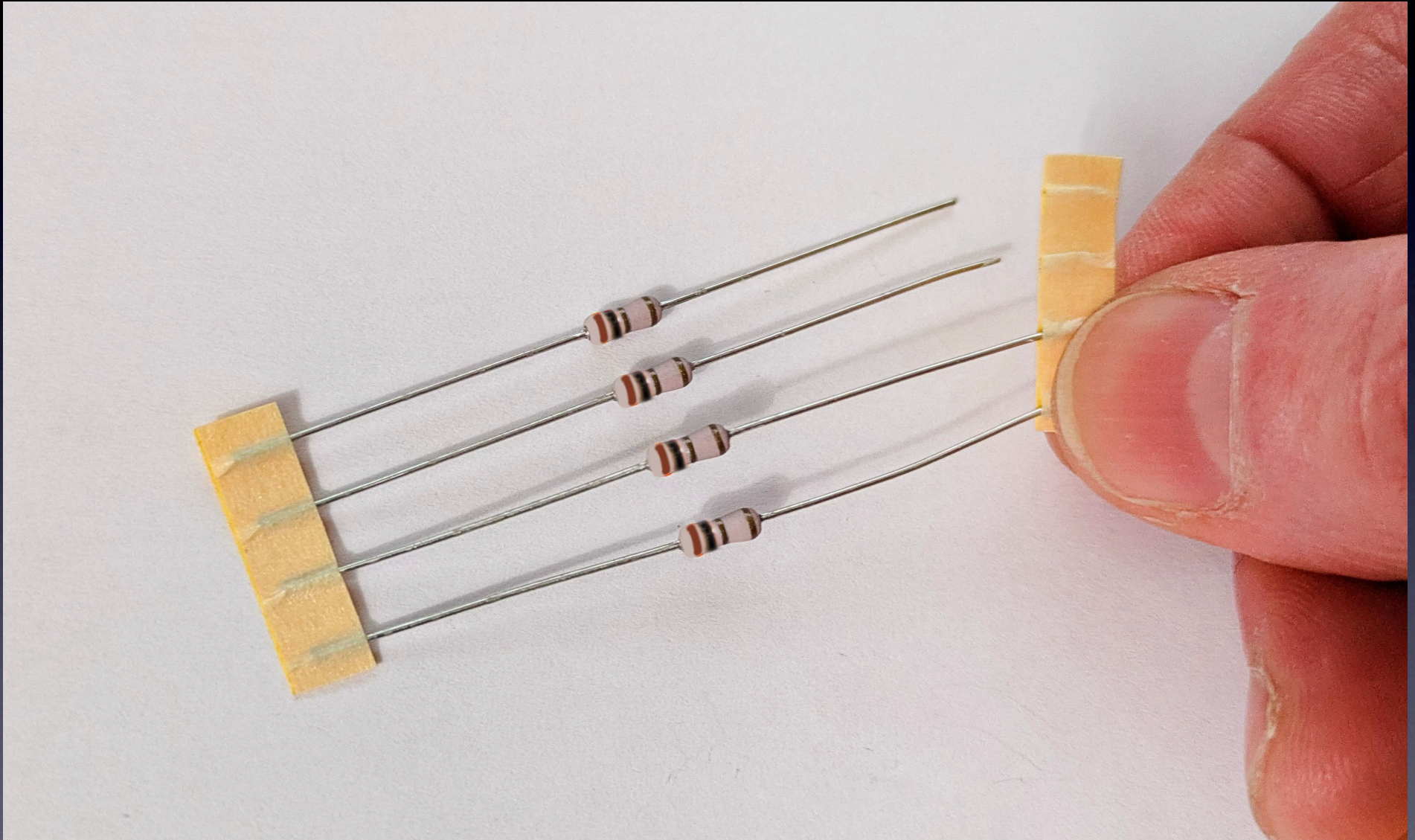

Some parts, such as resistors, need their leads bent first

If necessary, Bend leads
before inserting the part
into the board

wires coming out
from parts are
called "leads" –
they lead to the
part

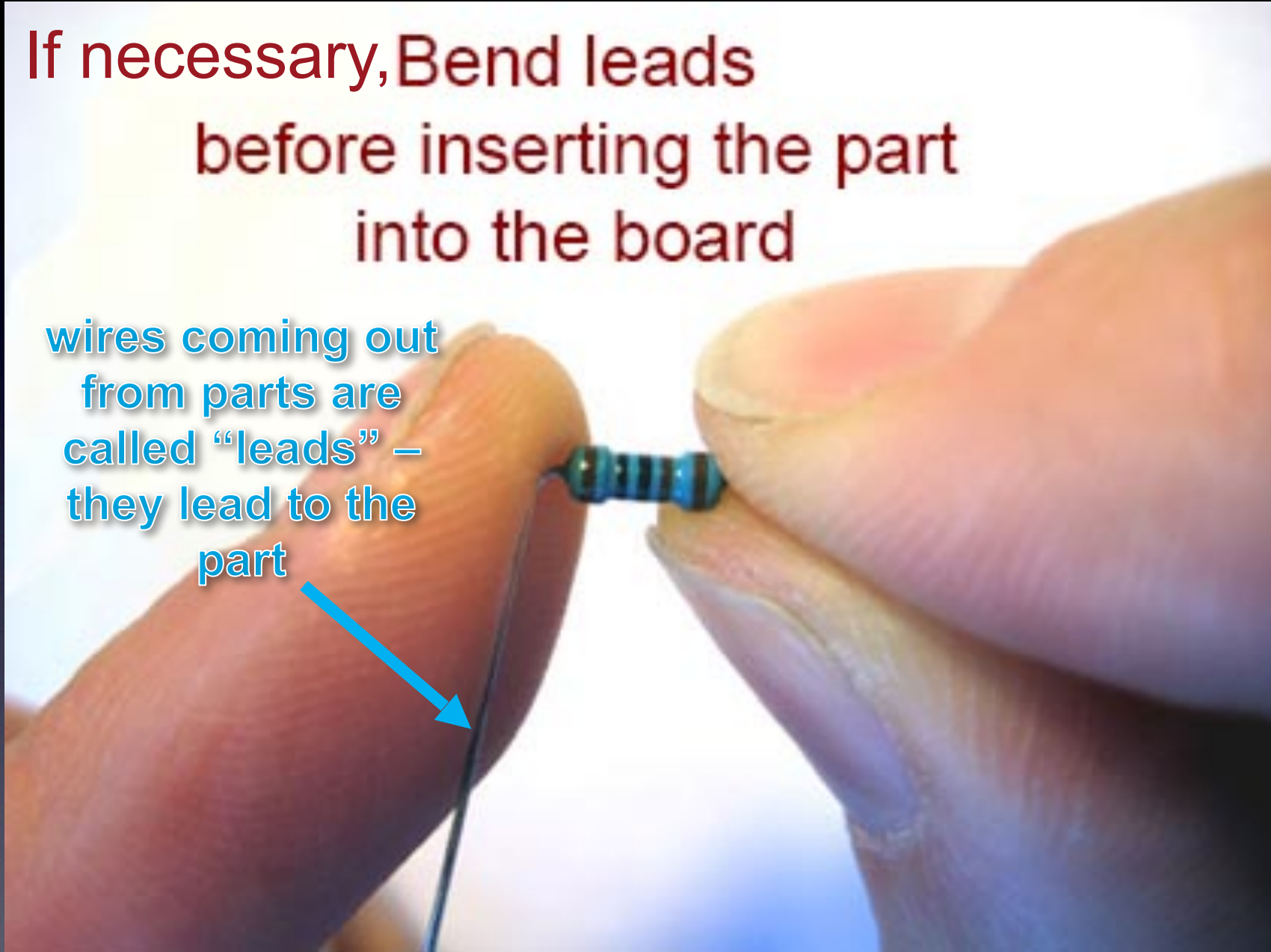



R1 – this is how it will look before inserting it into the board

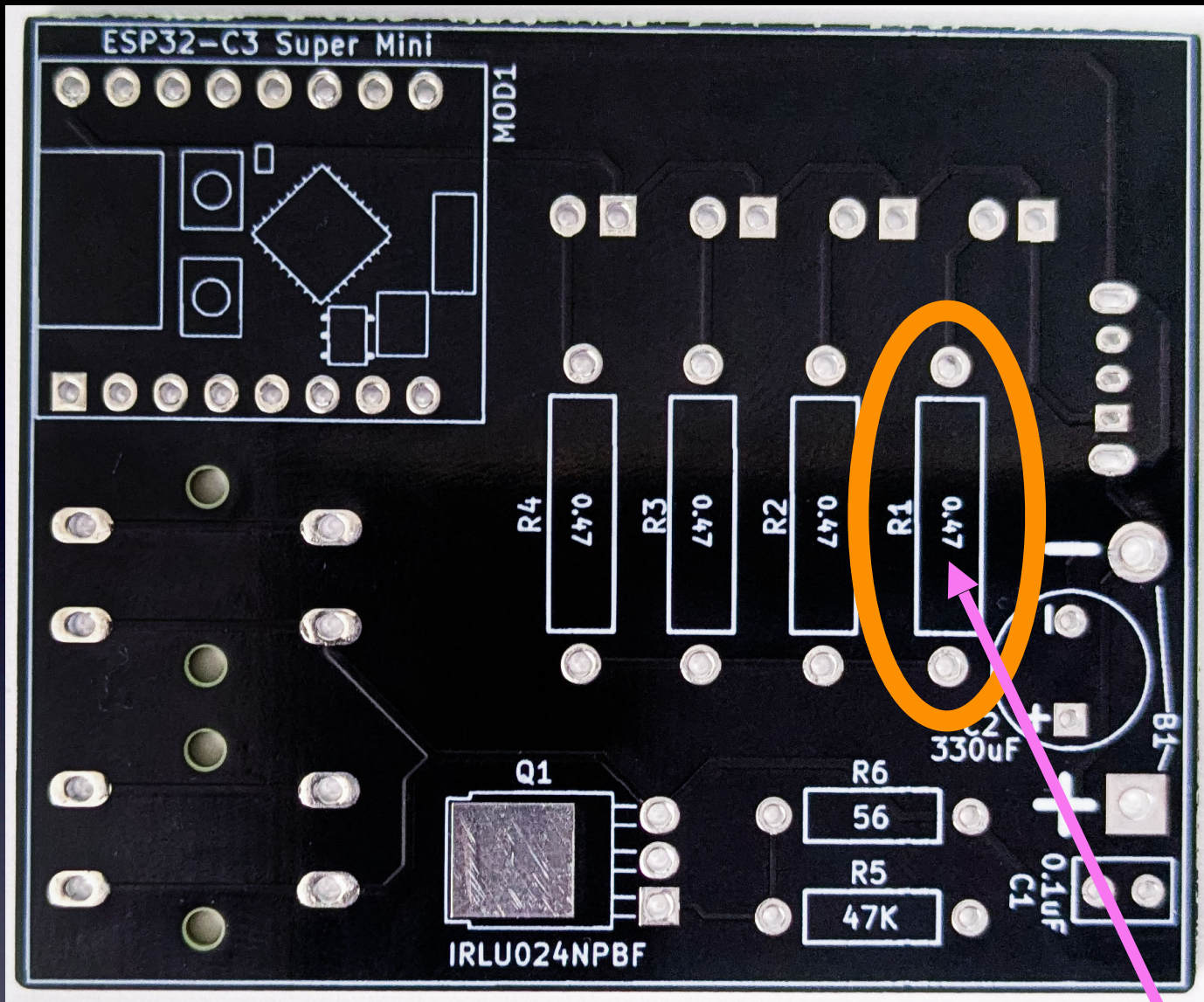

Resistor R1

NOTE:
R1-R4 now correctly say 1.0

Insert leads into pads

the circles with holes in them are called "pads"

there is one "pad" per lead for each part

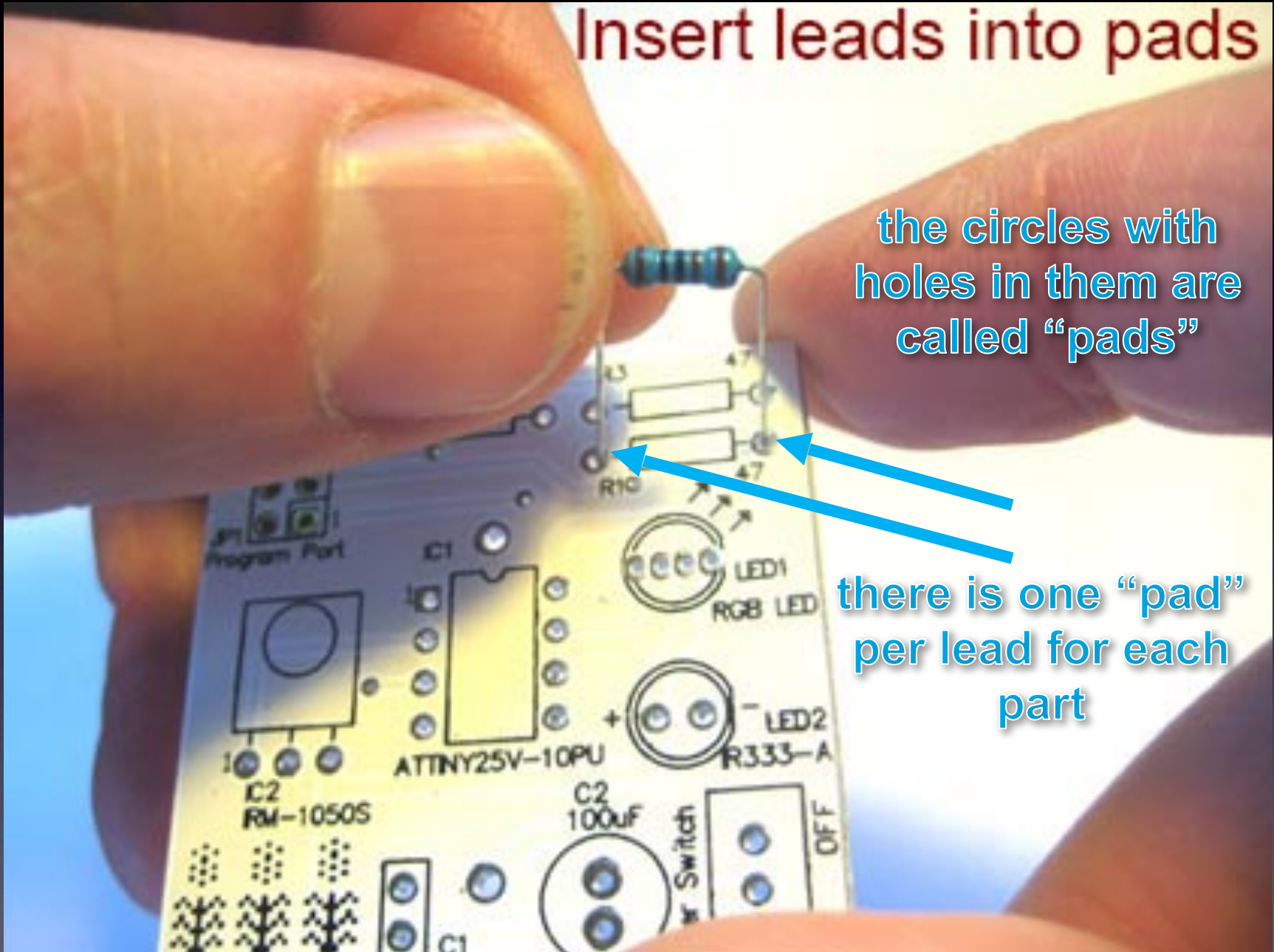

Push part down
all the way

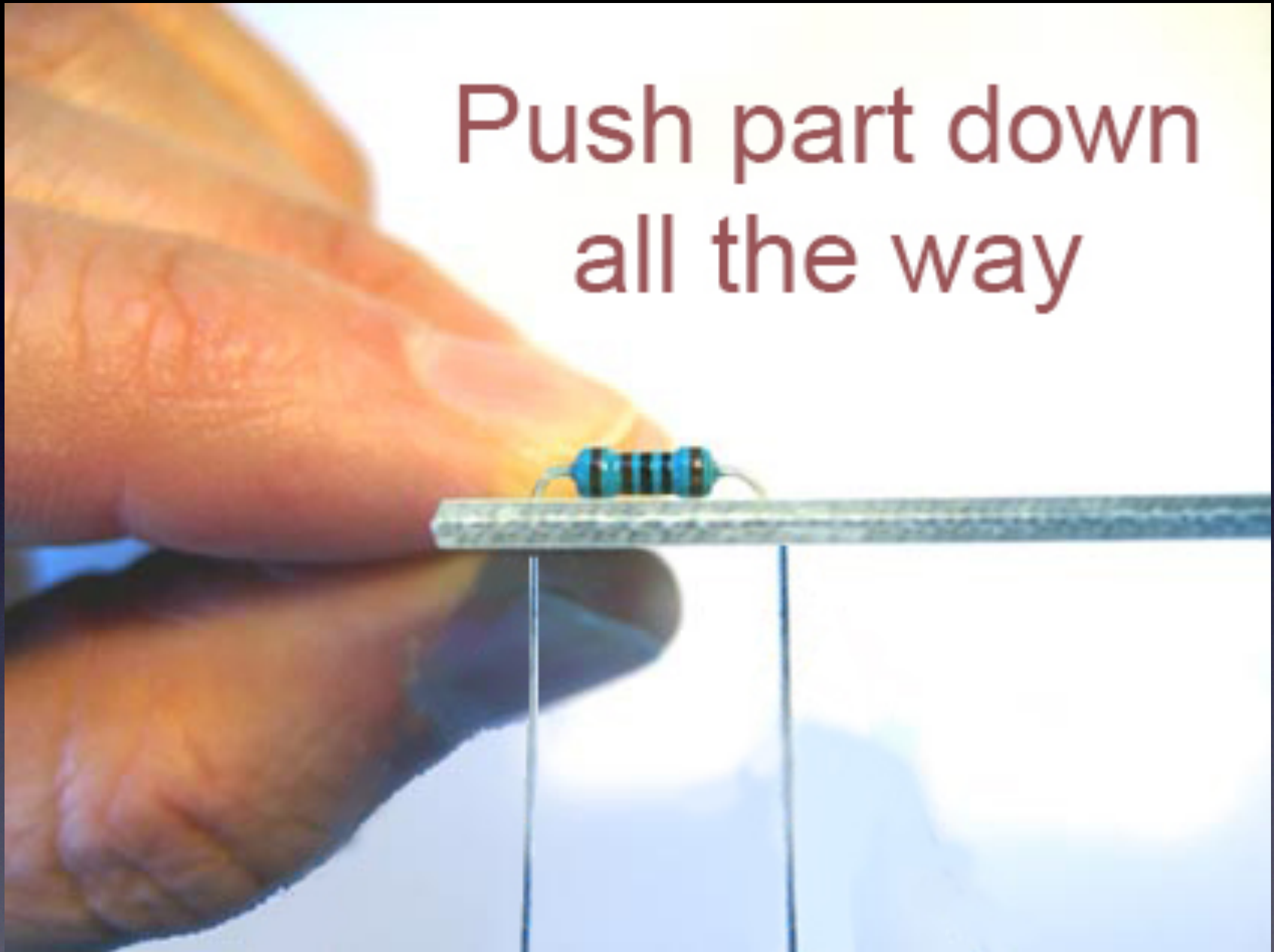

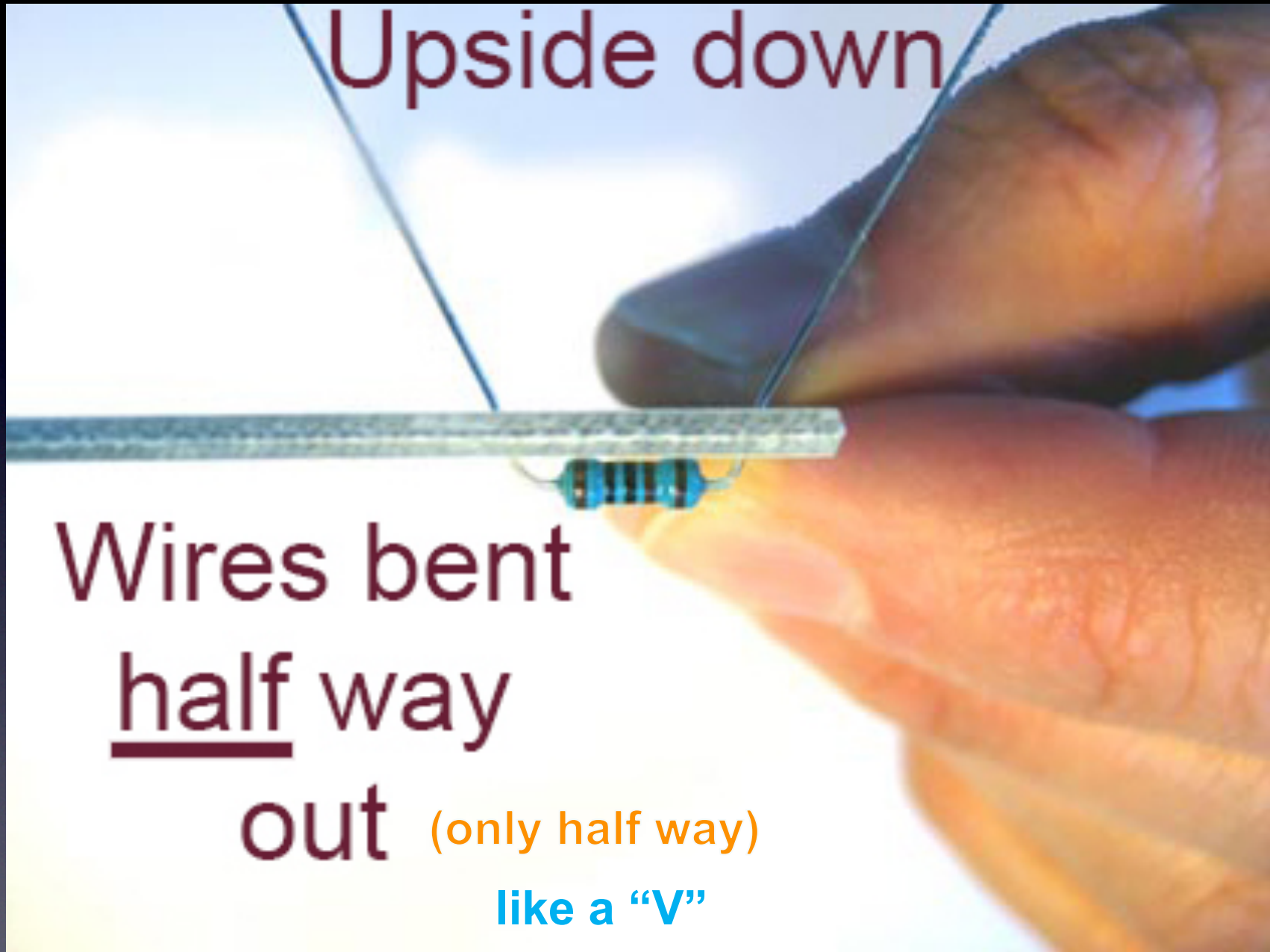

Upside down

Wires bent
half way
out

(only half way)

like a "V"

so that the part won't fall out while soldering it



Upside down

Wires bent
half way
out

(only half way)

like a "V"

Ready to Solder !

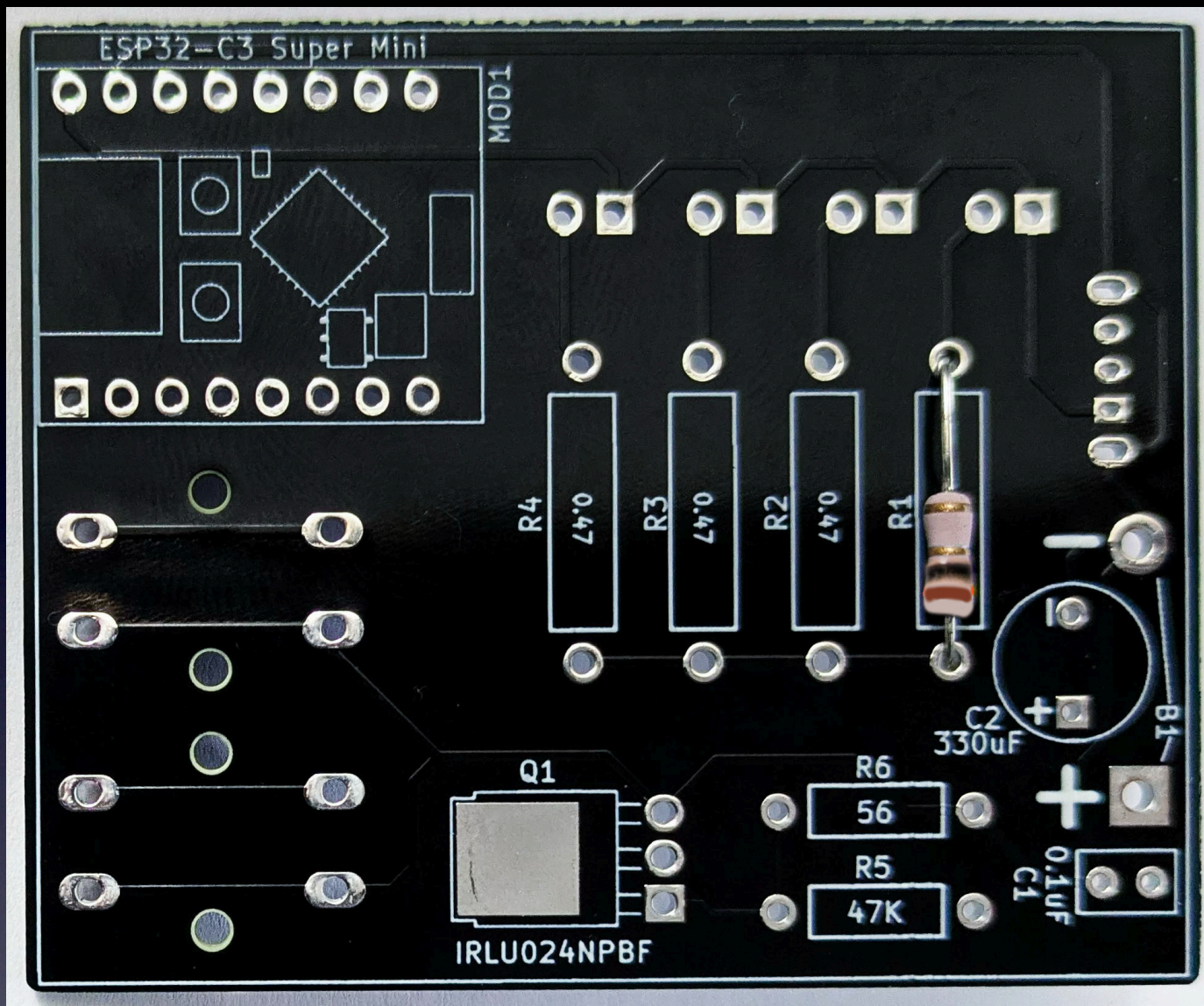

**Resistor R1
inserted**



How to hold a soldering iron

(Like a pencil – held from underneath)

Important

The best kind of solder for DIY electronics:

(Sn – Tin / Pb – Lead)

63/37 rosin core,
0.031" (0.8mm) diameter (or smaller)

(60/40 is also good)

Note:

Most
Lead-Free solder
has poisonous fumes!

A good kind of solder for DIY electronics:

*This is the only good **Lead-Free** solder I have found!*
(after years of searching)



Kester
K100LD Rosin
(not “No Clean”)
0.031” diameter (0.8mm)

A good kind of solder for DIY electronics:

This is the only good *Lead-Free* solder I have found!
(after years of searching)

Kester **K100LD Rosin** Solder
0.031" diameter (0.8mm)



Note:

If you use *Lead-Free* solder
it is *helpful*
to also have
flux paste in a syringe
and *Isopropyl Alcohol*



99%



Another good kind of solder for DIY electronics:

*This is another good **Lead-Free** solder I have found!*



**Duratool
D01685 Rosin**

0.7mm diameter

*(as good as the
Kester K100LD Rosin)*

Another good kind of solder for DIY electronics:

This is another good **Lead-Free** solder I have found!



**MG Chemicals
4900 Rosin (112g, 227g, 454g)**

0.8mm diameter

*(as good as the
Kester K100LD Rosin)*

Another good kind of solder for DIY electronics:

*This is another good **Lead-Free** solder I have found!*



iFixit
IF145-077-2 (12g)
1.0mm diameter

*(as good as the
Kester K100LD Rosin)*

3 Safety Tips...

Safety Tip #1:

Hot!!

(When you touch the tip,
you will let go quickly every time!)

Safety Tip #2:
Soldering chemicals
are toxic

But they easily wash off your hands
with soap and water

Safety Tip #3:

(coming soon...)

2 secrets
to good soldering...

Secret #1:

Clean the tip!

(before every solder connection)

Bang (lightly) 3 times,

Swipe, Rotate, Swipe (on the sponge):

Keep the tip shiny silver!

knock solder off the tip



Lay clean tip across half of the pad,
touching the pad and lead
for 1 second

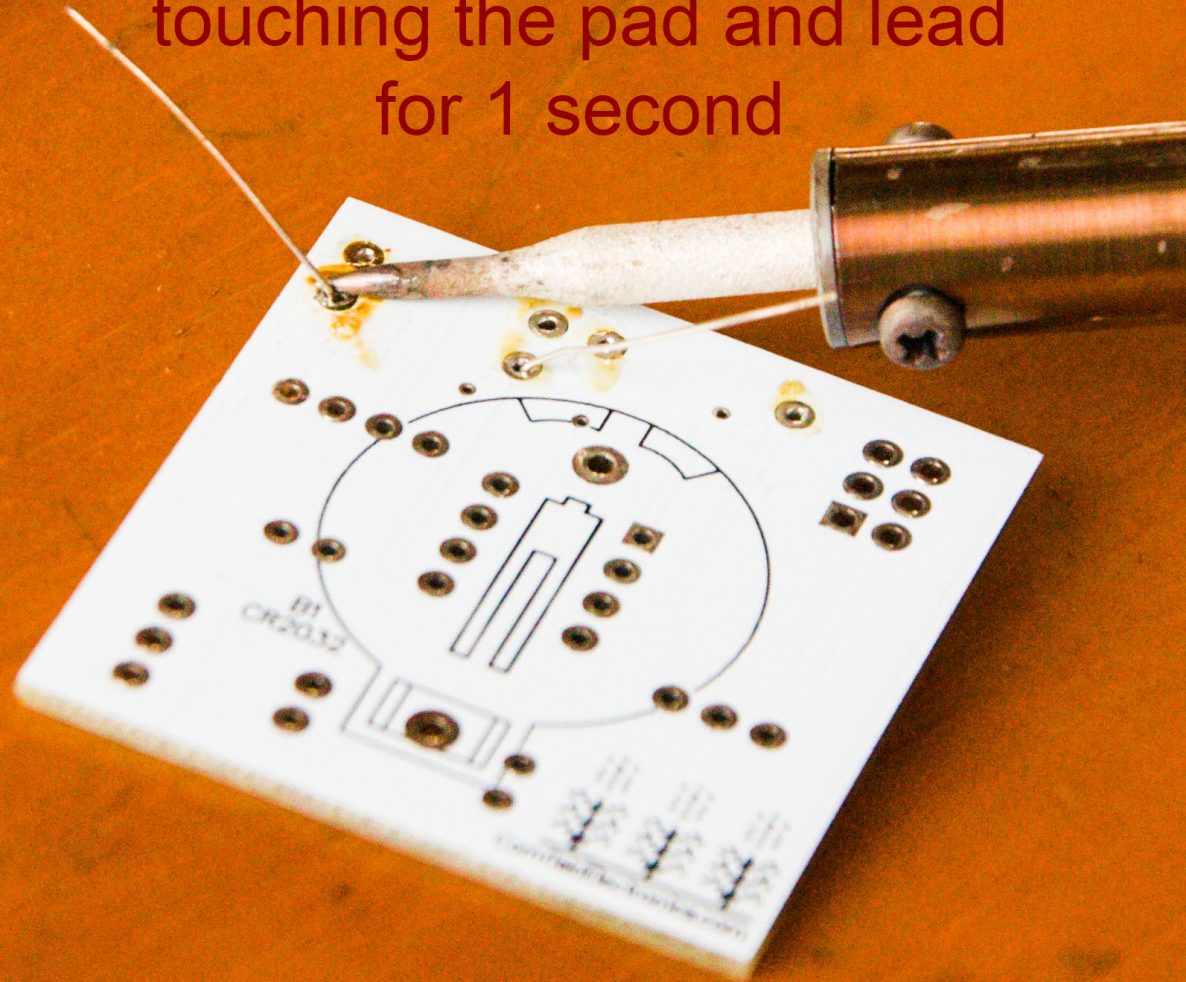

Do this quickly (slowly doesn't work well) – solder in & out in about 1 second

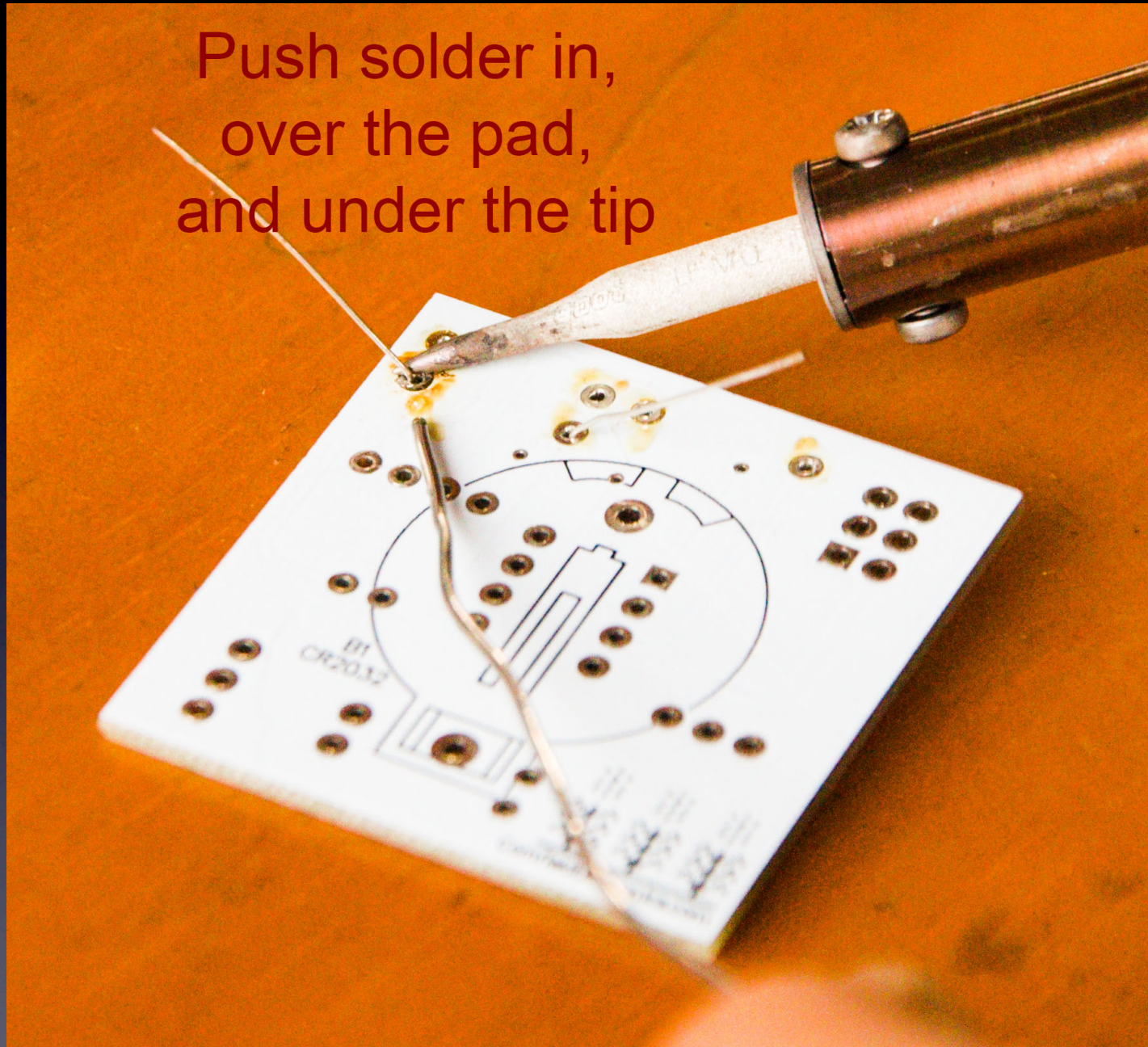

IMPORTANT: Make sure solder melts on the underside of the soldering iron tip (not the side or top of the soldering iron tip)!

Do this quickly (slowly doesn't work well) – solder in & out in about 1 second

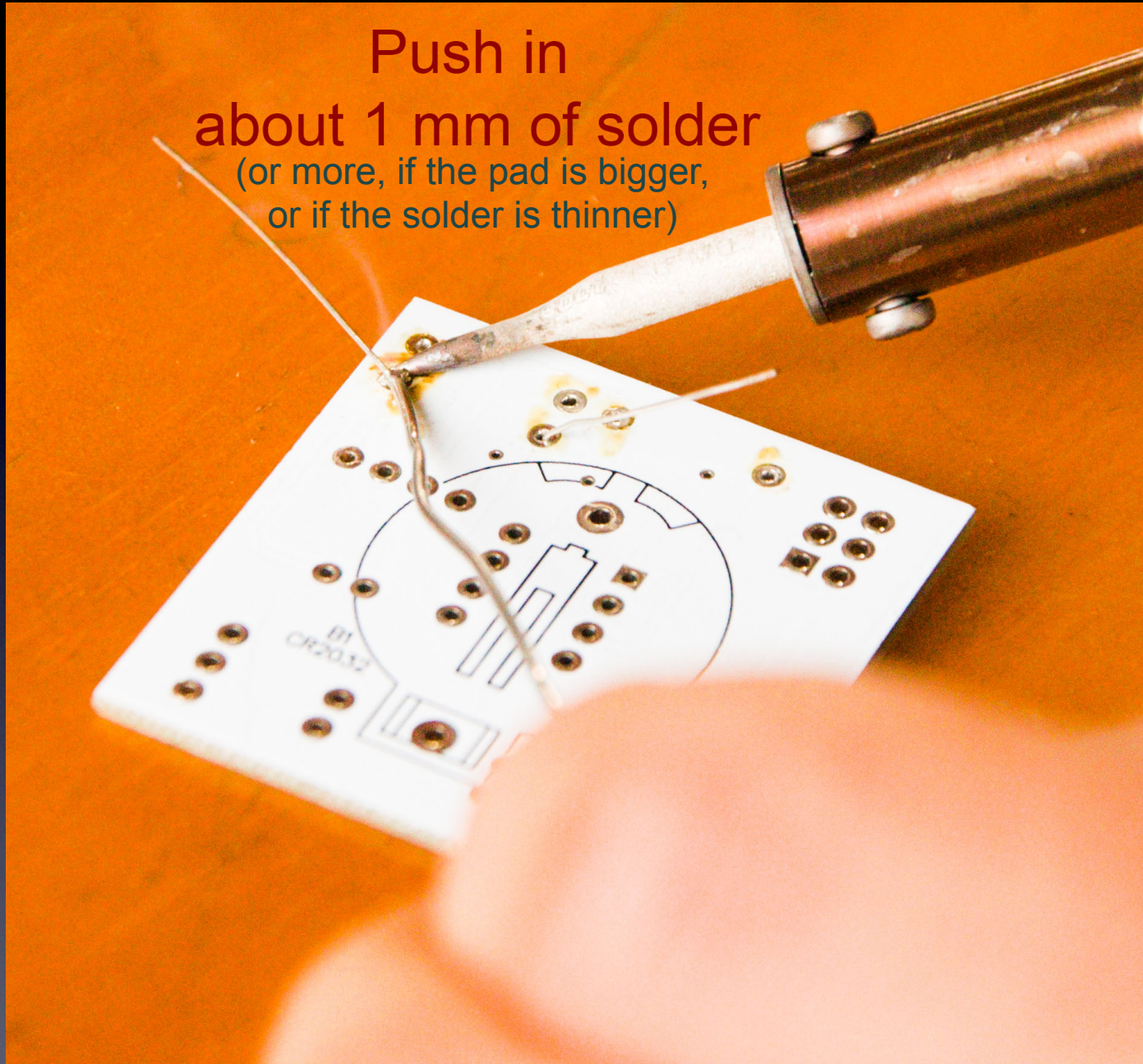

Make sure solder melts on the underside of the soldering iron tip
(not the side or top of the soldering iron tip)!

HEY !!!

KEEP HOLDING TIP DOWN FOR 1 MORE SECOND !!

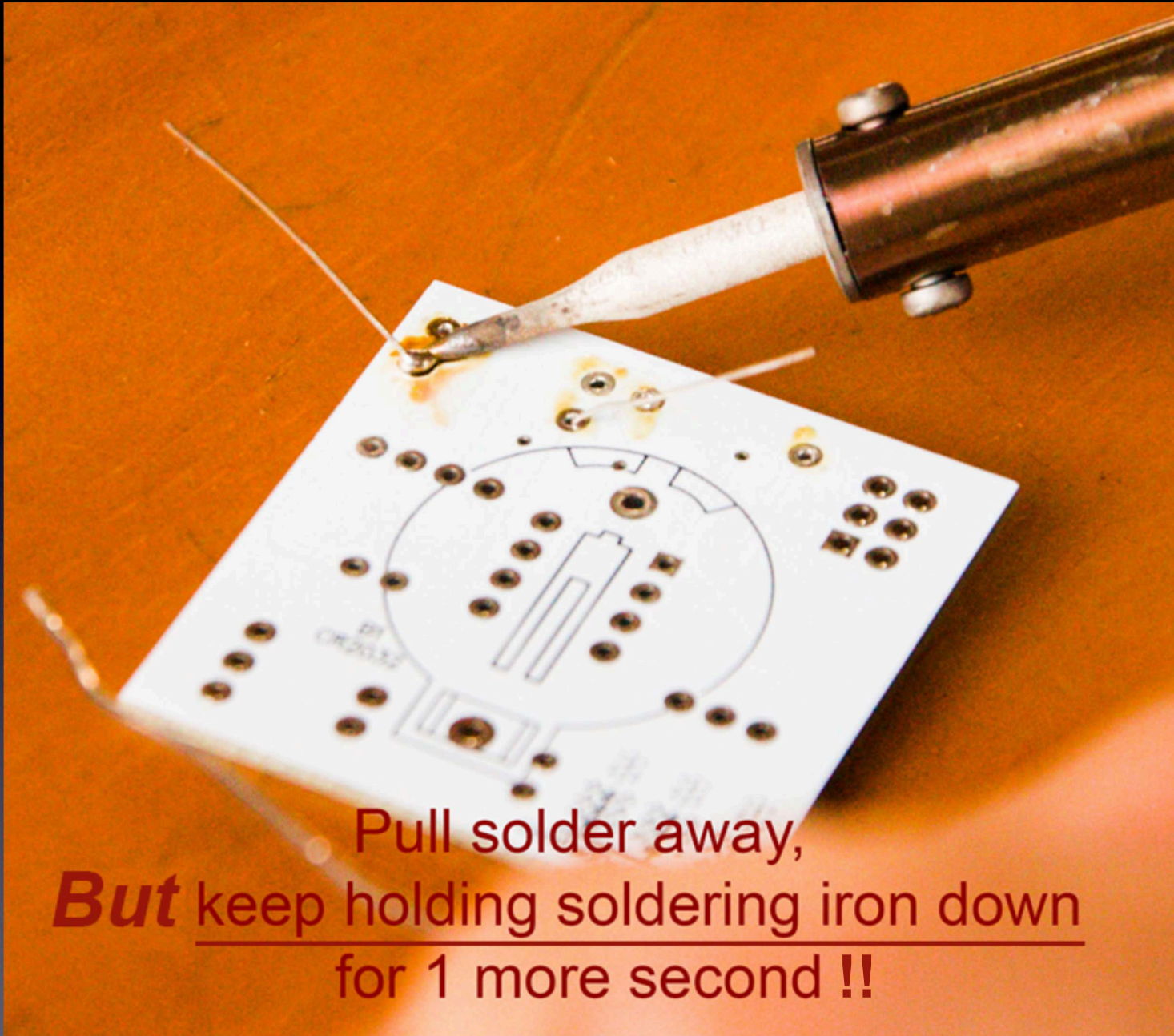

Pull solder away,
But keep holding soldering iron down
for 1 more second !!

WAIT !!
Don't lift the tip !!

Secret #2:

Keep hot tip down
1 second
For solder to flow !!

Now

Lift soldering iron

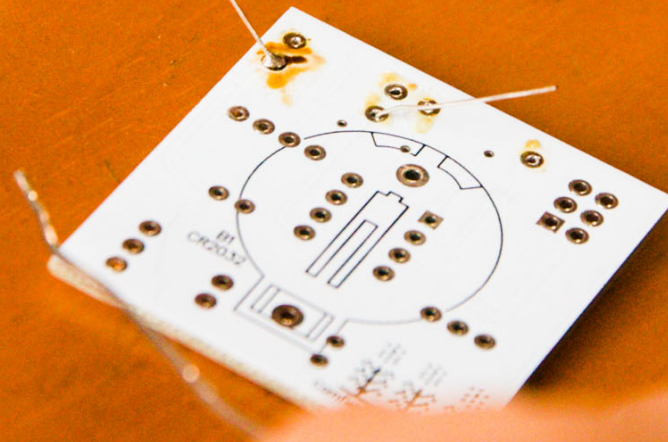

**A Little Mountain
of Solder**

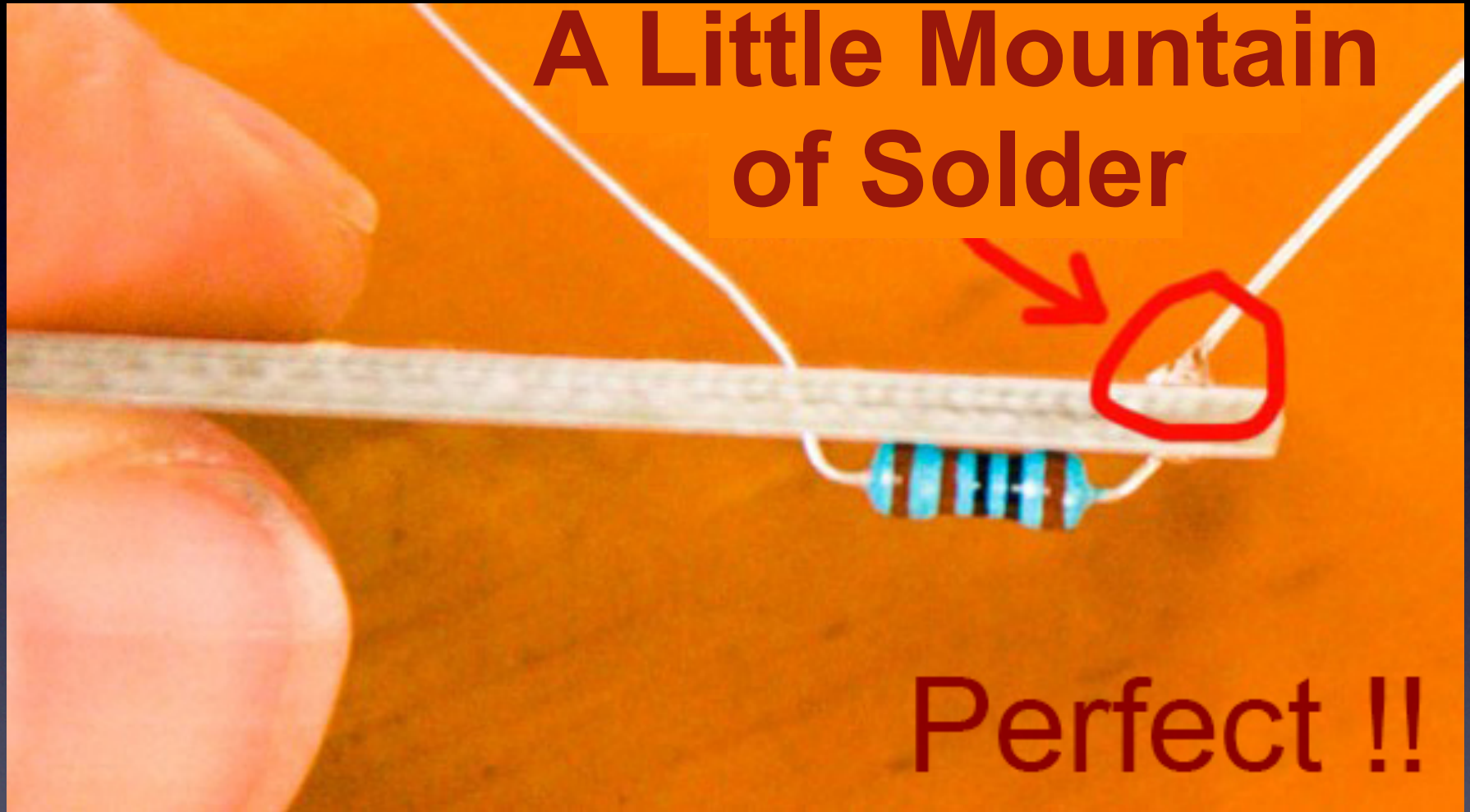

Perfect !!

If you can see any of the pad, or the hole, you need more solder
– so, just do all the steps again to make it perfect.

The Rhythm !

is just as important as the preceding steps!

The Rhythm !

and speed (about 1 second per step)



The Rhythm !

and speed (about 1 second per step)

Clean the tip



The Rhythm !

and speed (about 1 second per step)



Tip **Down**

The Rhythm !

and speed (about 1 second per step)



Solder **In**

The Rhythm !

and speed (about 1 second per step)



Solder **Out**

The Rhythm !
and speed (about 1 second per step)



WAIT !

The Rhythm !

and speed (about 1 second per step)



Lift Tip

Solder all of the leads of the part to the board

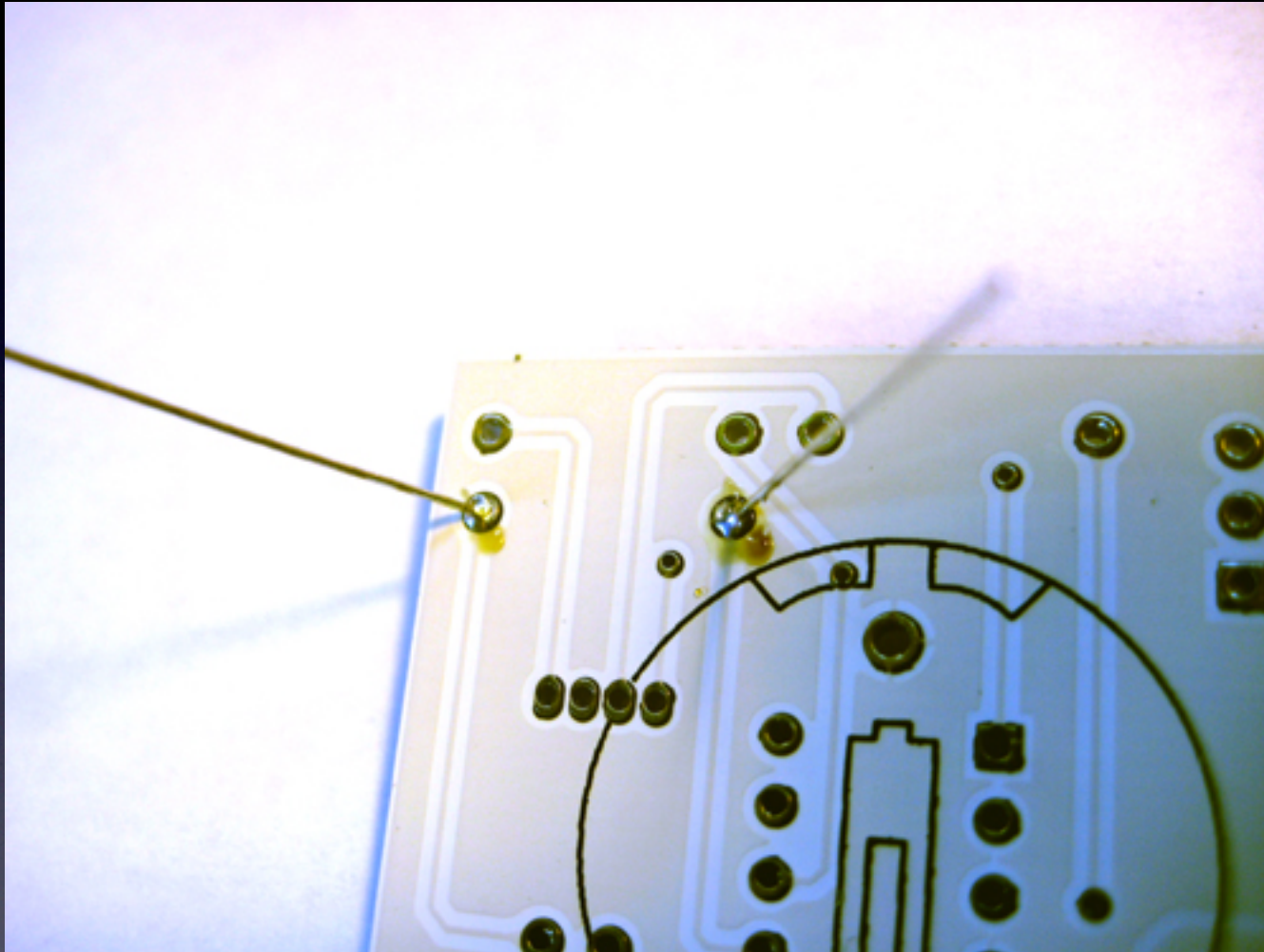

For this part, there are two leads

Here you can see two good solder connections

Two good solder connections

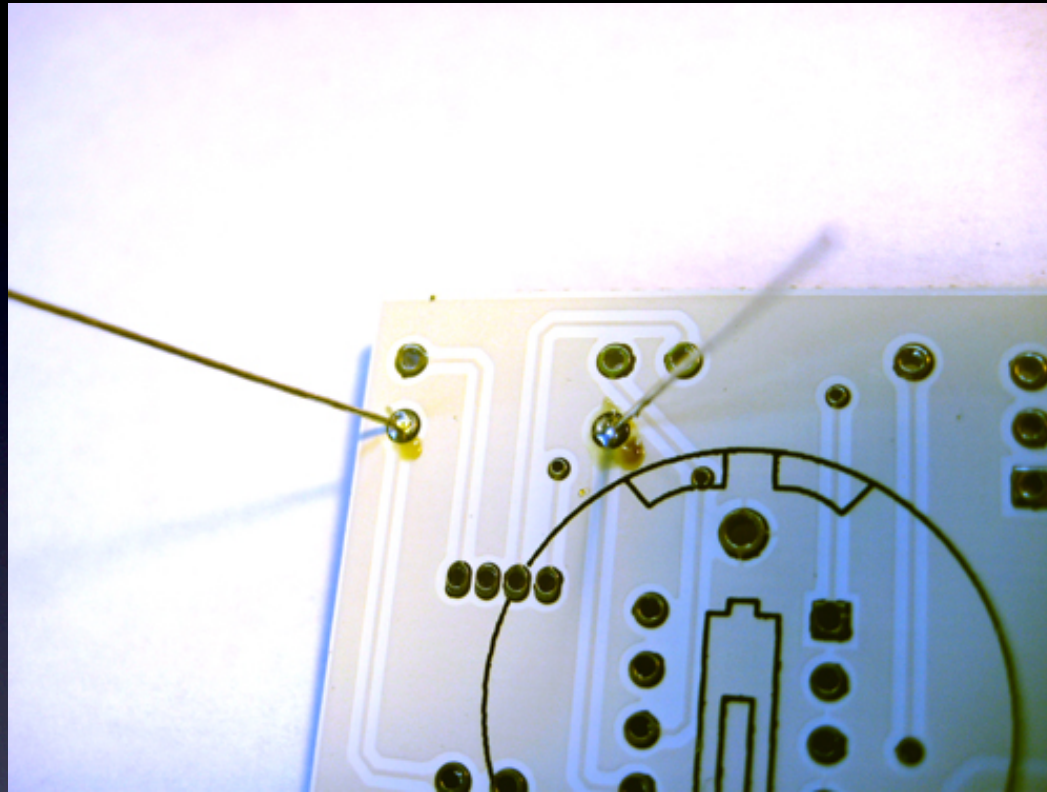

- Little mountains (not flat)
- Pads totally covered in solder
- Can't see the hole
- No connections to other pads

Now cut the leads short

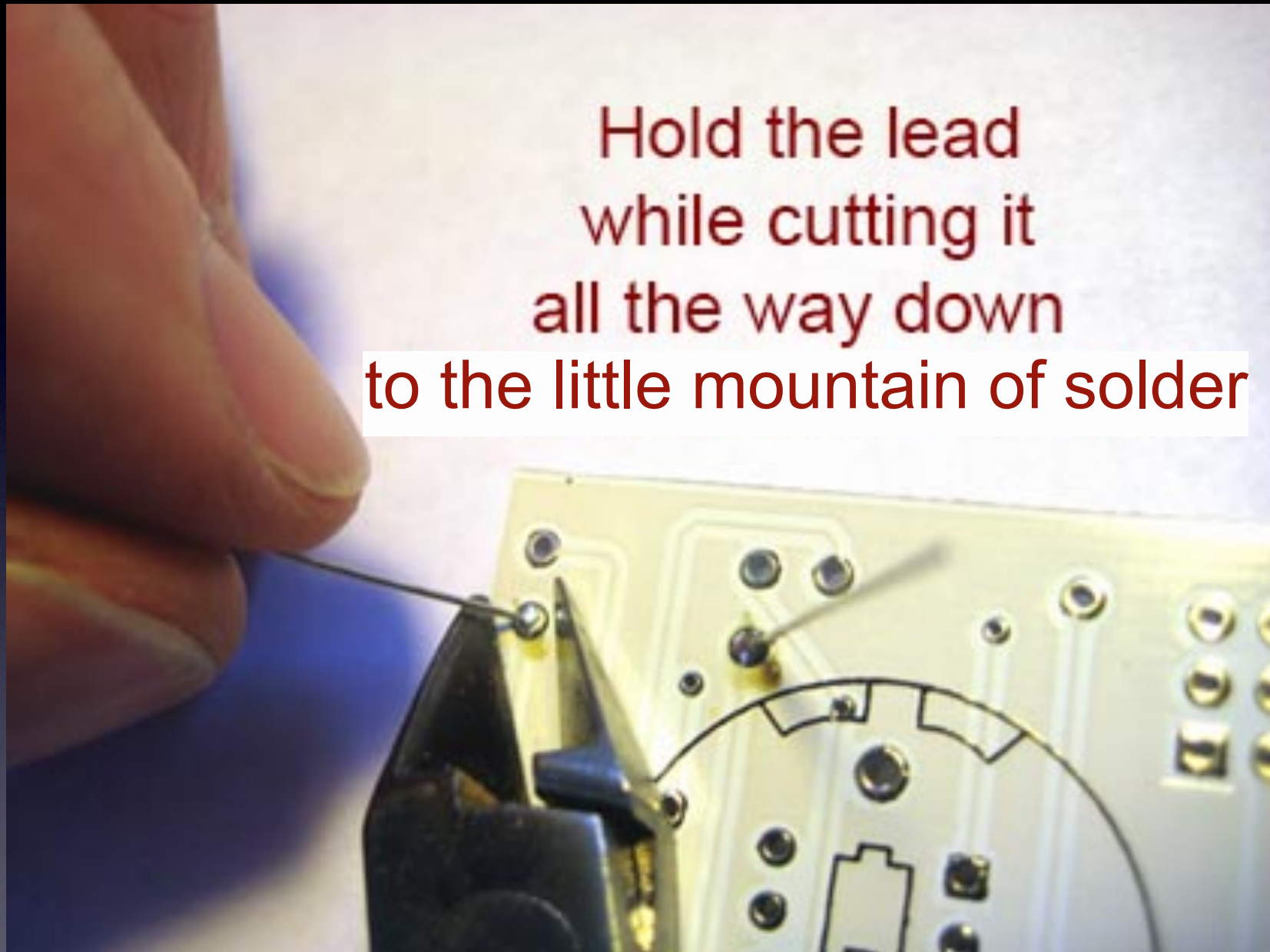

Cutting with the tip of the wire cutter gives you more control

Safety Tip #3:

Hold or cover the lead !

(or it will fly into your eye!)

(They like doing that – so please hold or cover the lead when you cut.)



All done !

No wires sticking out

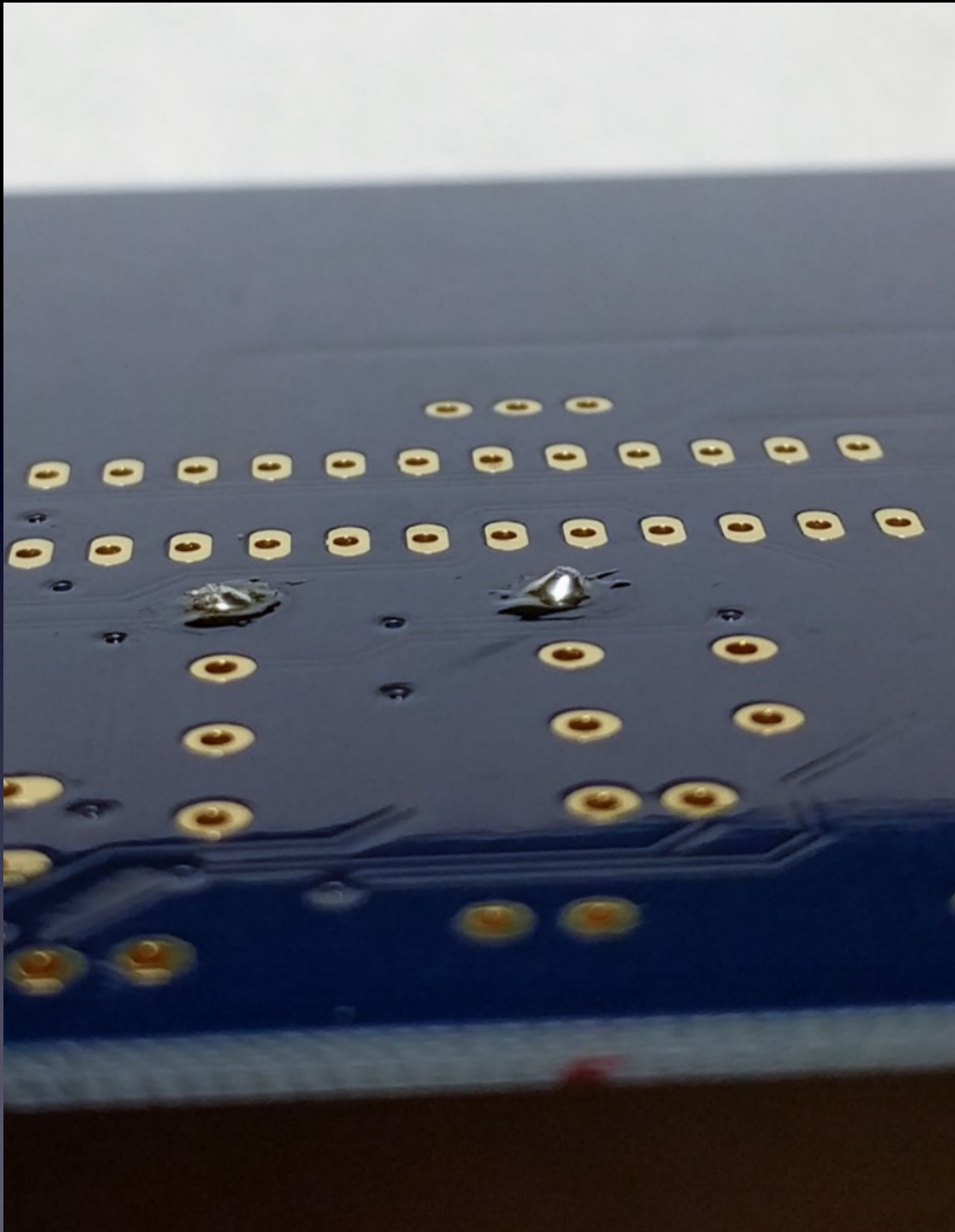

A closer look at good solder connections

Notice that:

- Each connection is a small mountain (not flat)
- You cannot see any pad (they're totally covered with solder)
- You cannot see the holes (they're totally covered with solder)
- No connections to other pads

One part at a time

Till all the parts are soldered

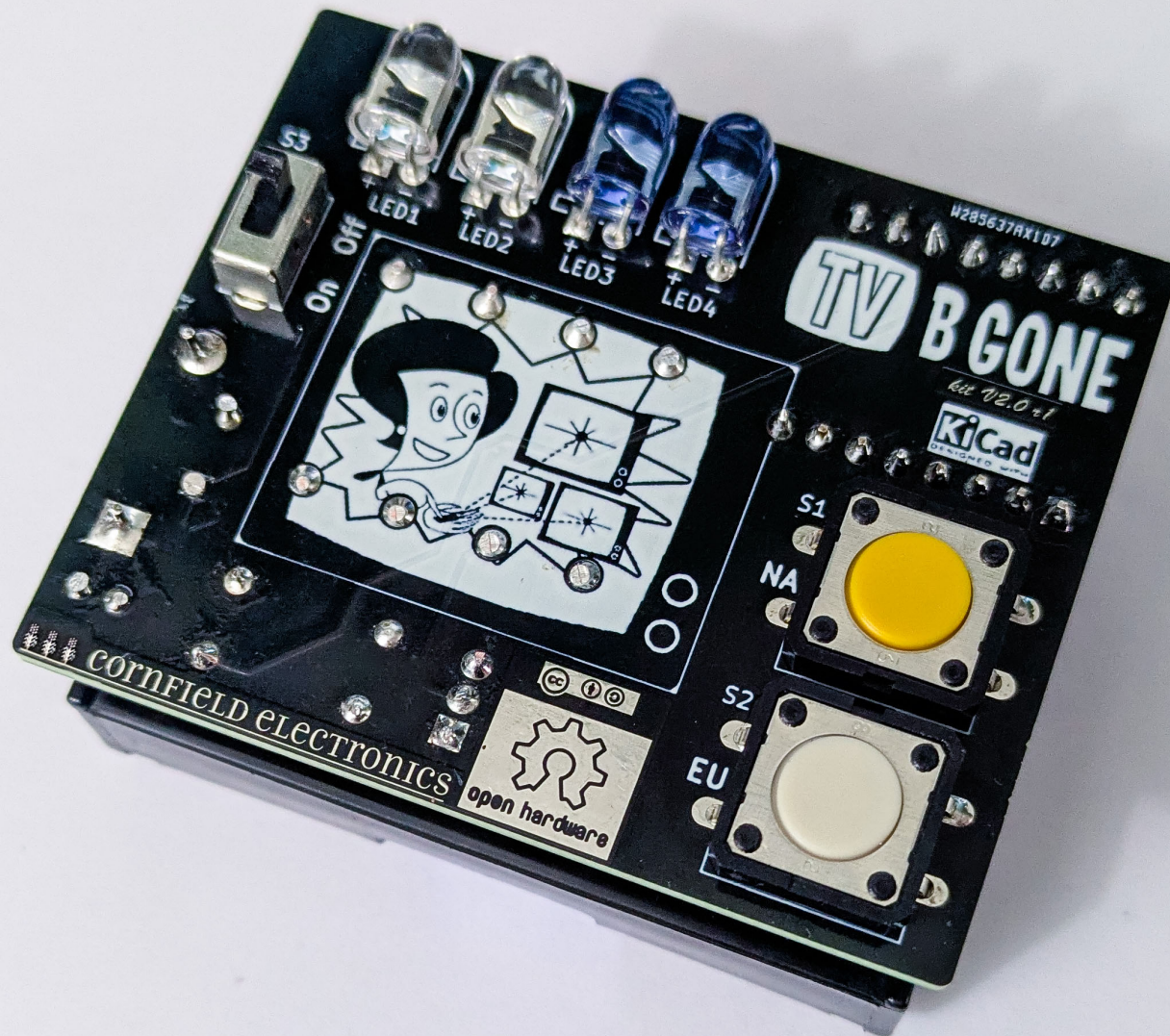

And it will look like this when you're done.

If you used any *flux paste* for re-working problems



The bottom of the PCB will be sticky from the flux

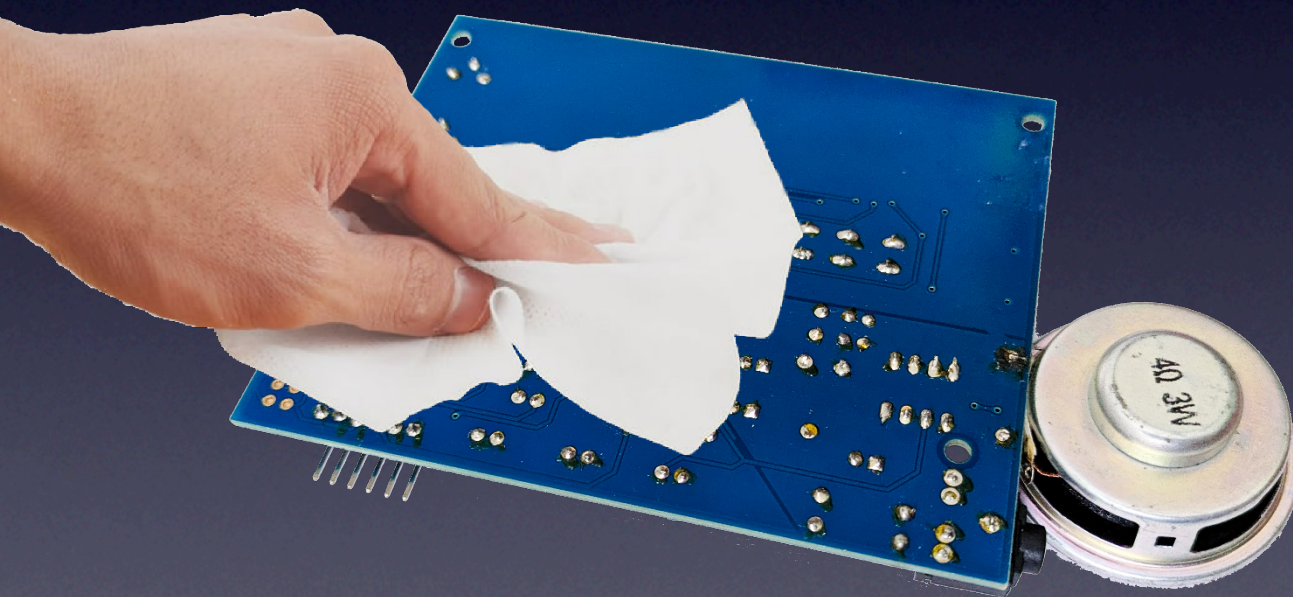

You can clean it with a cloth wet with *Isopropyl Alcohol*

Then test with batteries,

And it works!

(Or you start debugging.)

Let's start!

NOTE:

R1-R4 now correctly say 1.0

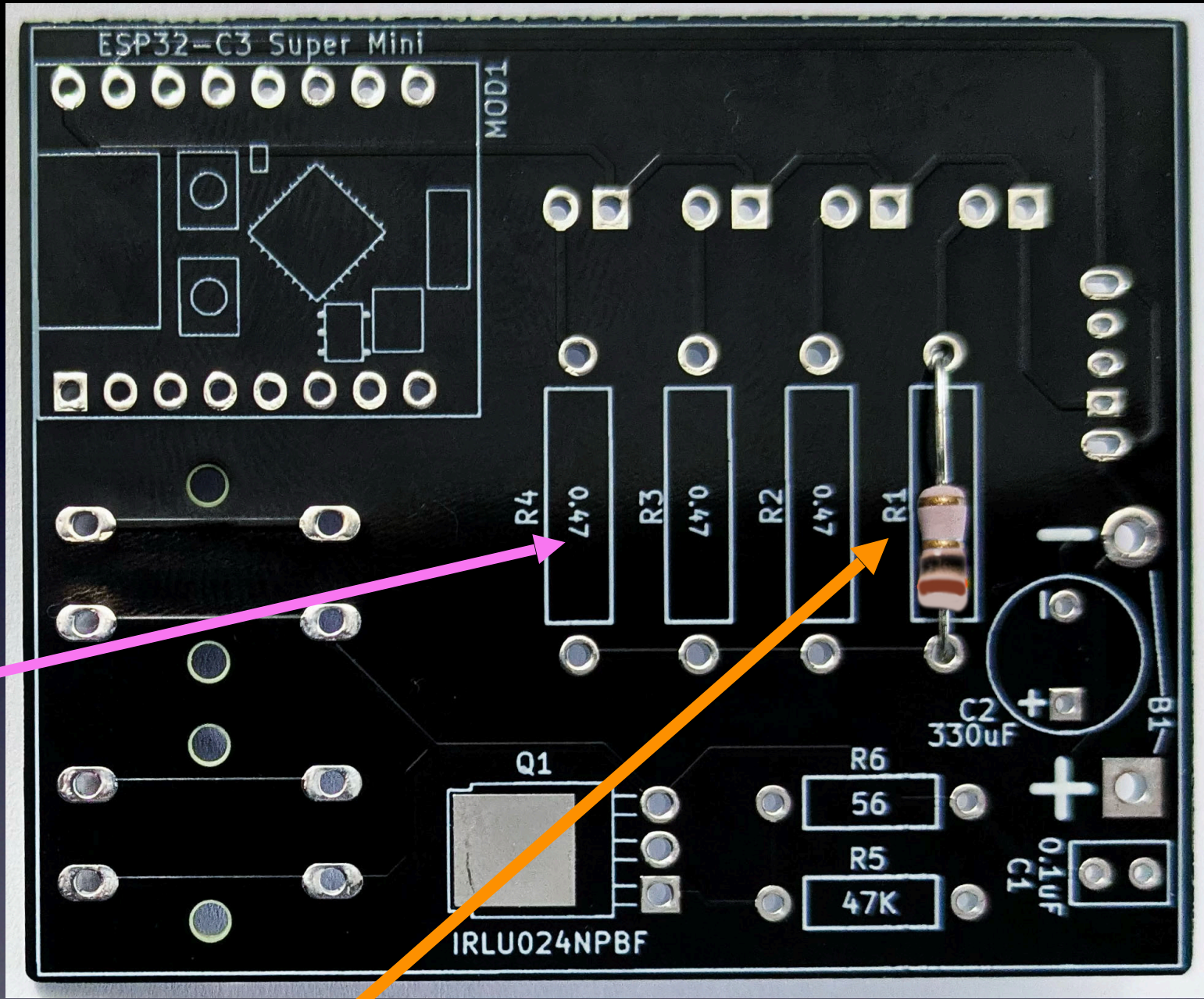

Resistor R1

(Direction does not matter)

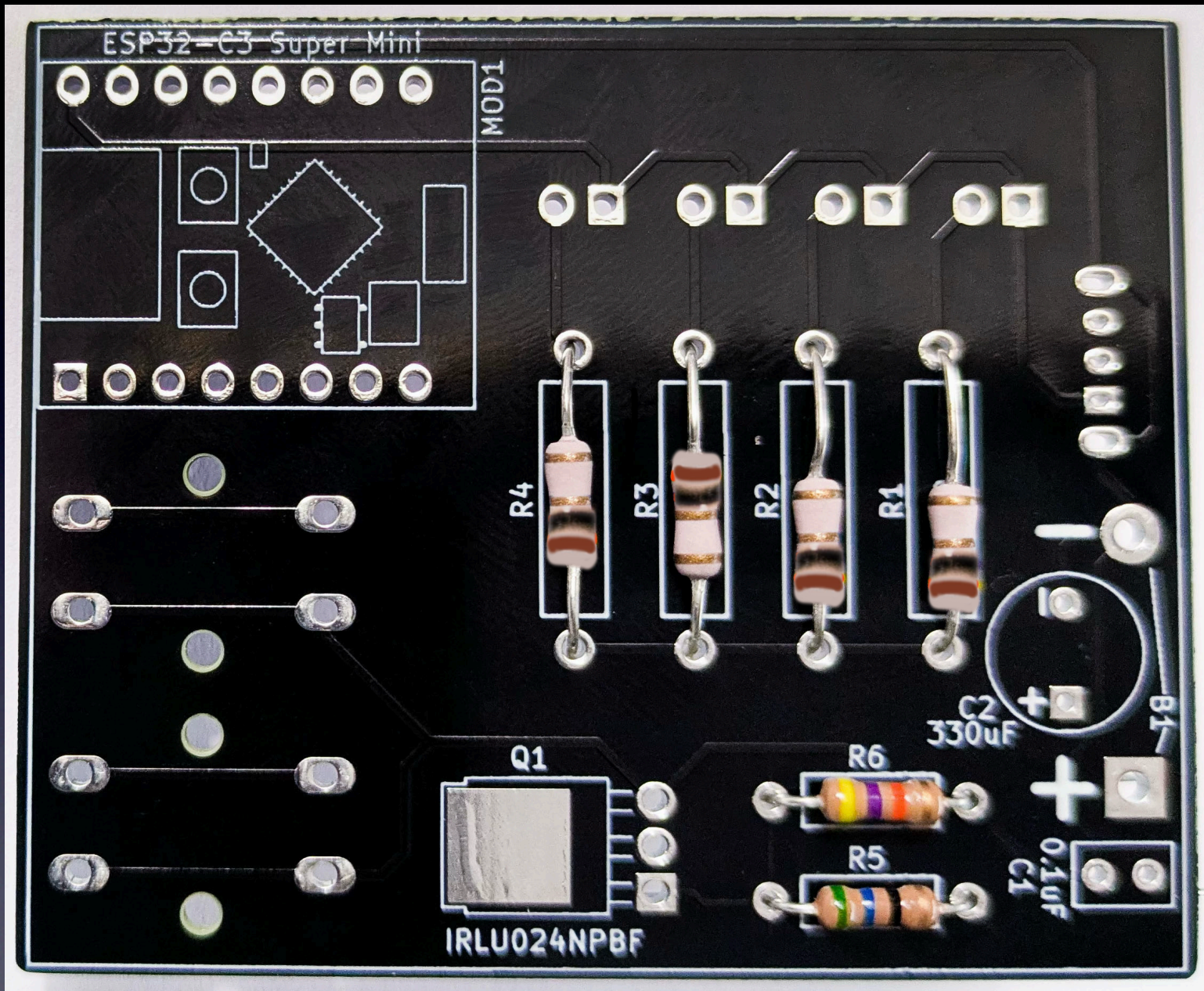

All 6 Resistors: R1 - R6

(Direction does not matter)

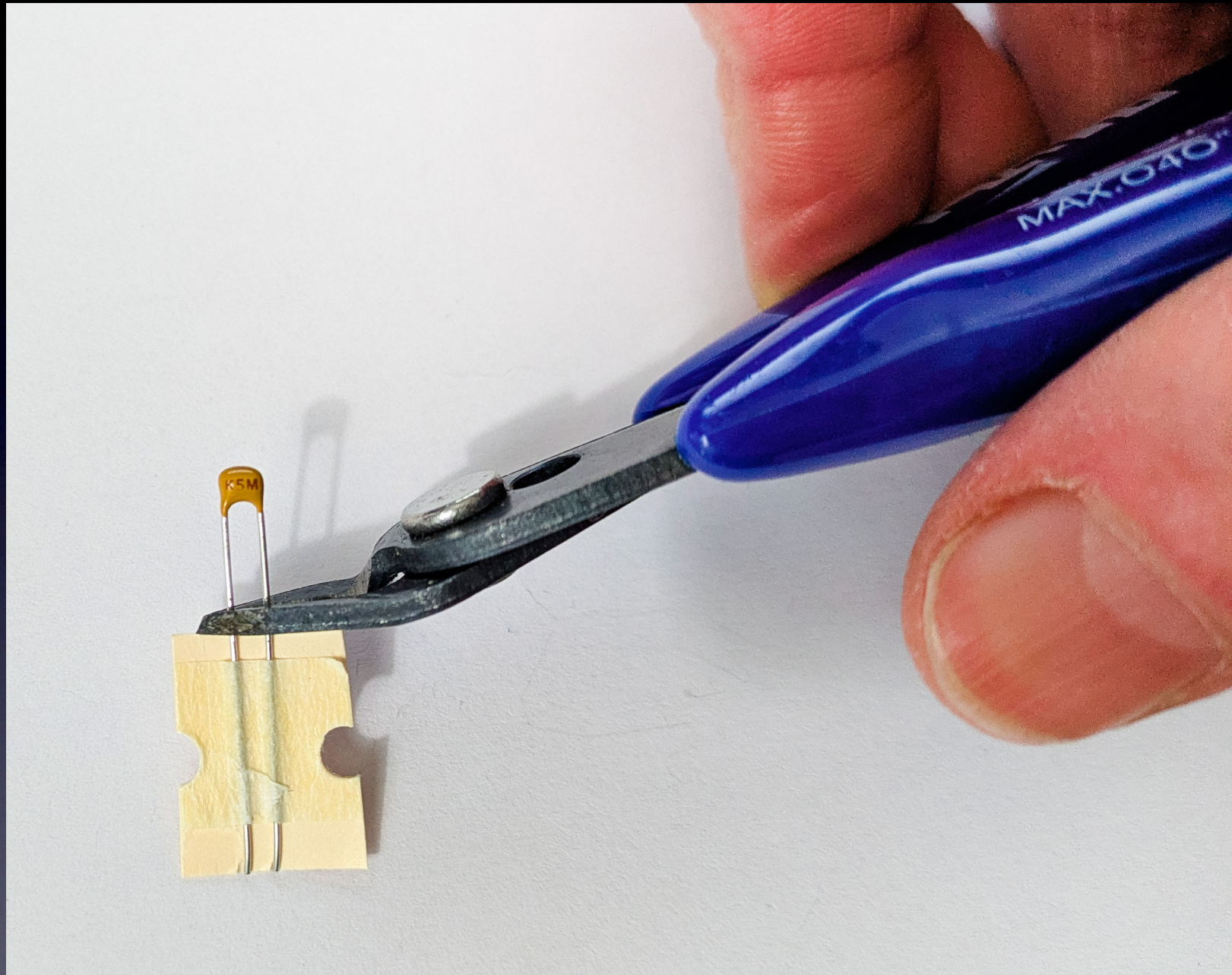

Capacitor C1 — cut off from tape

NOTE:

R1-R4 here are 0.47 — but we are using 1.0 .
All following photos show 0.47 resistors.

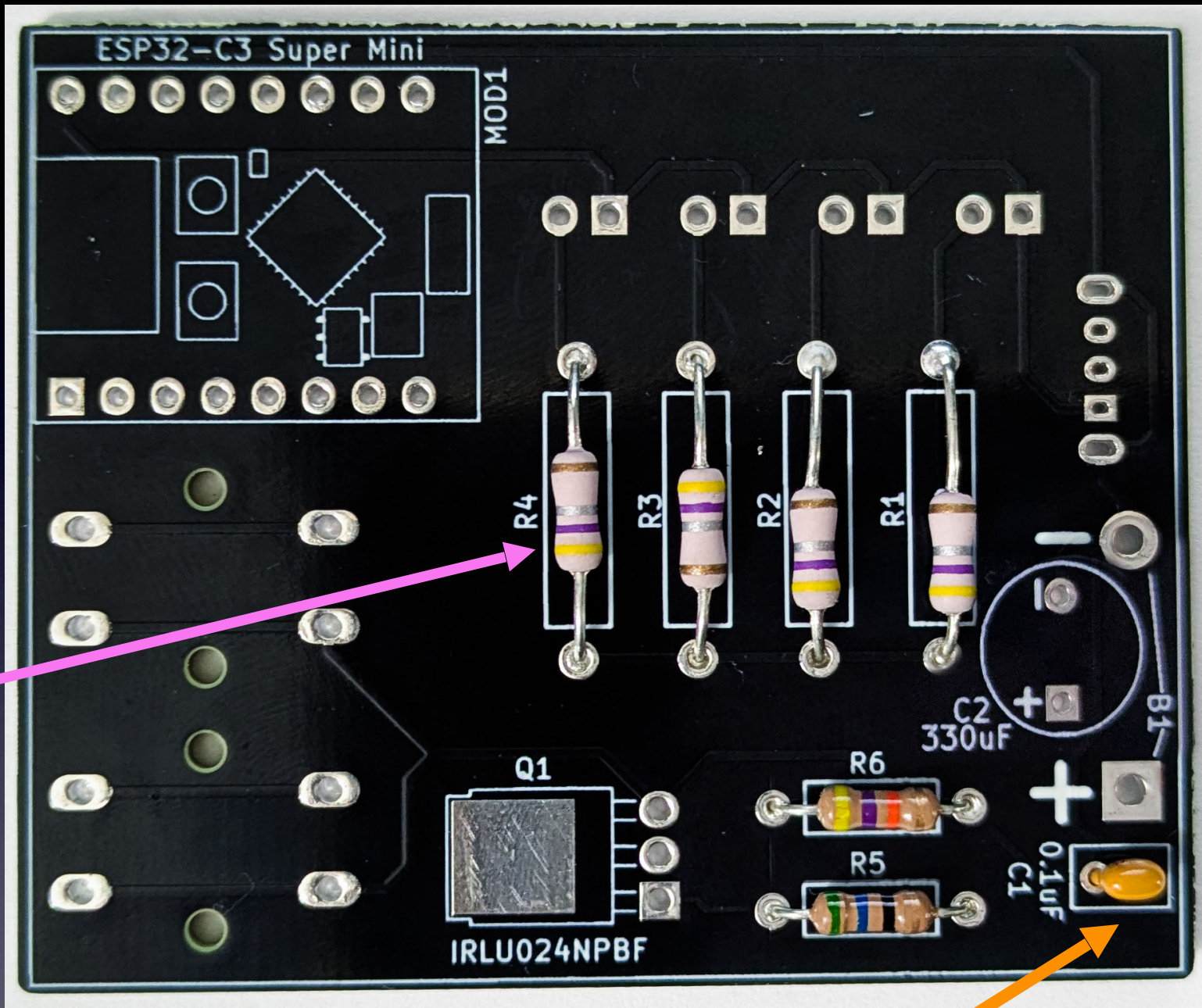

Capacitor C1

(Direction does not matter)

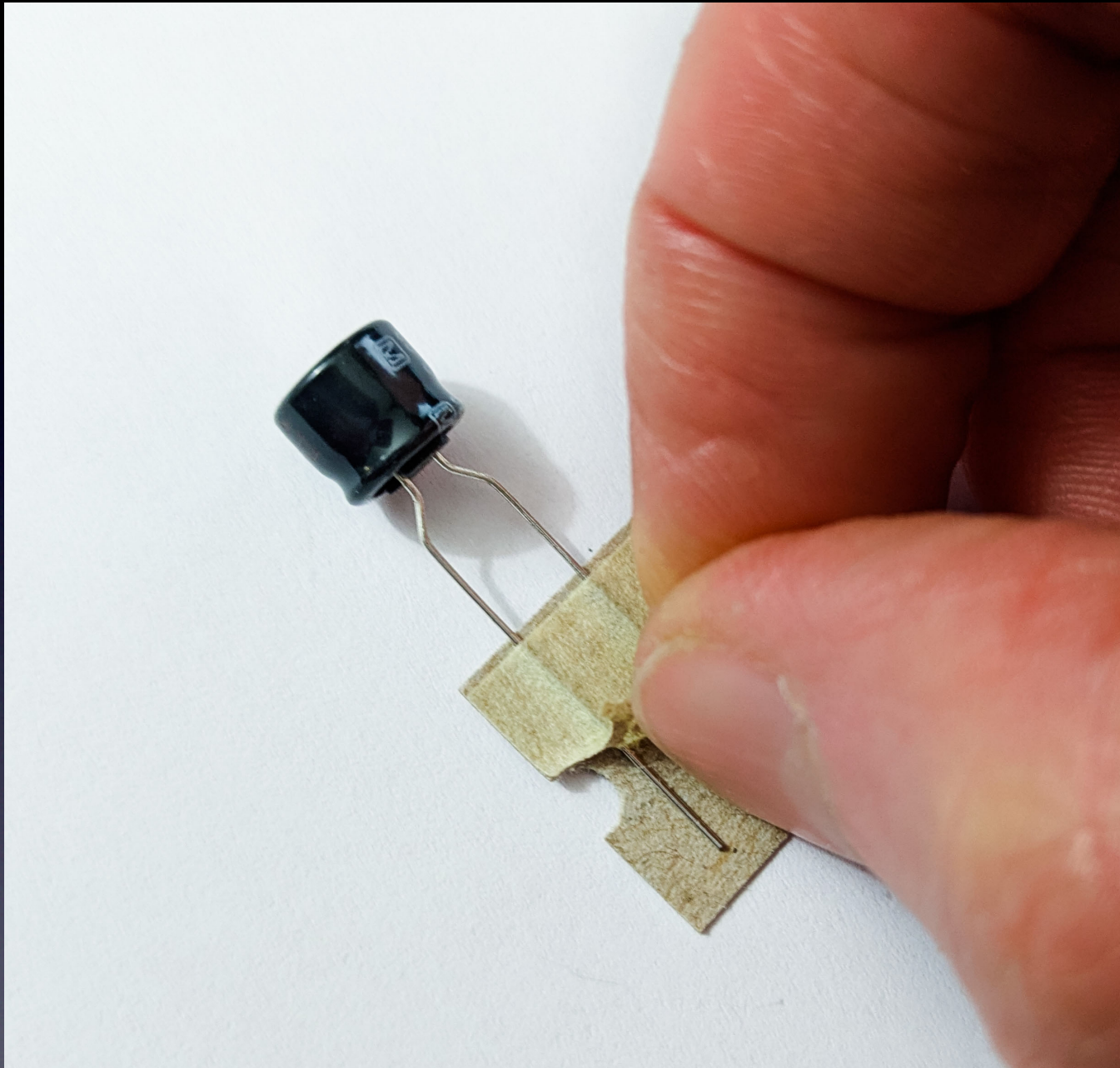

Capacitor C2 — peel off tape

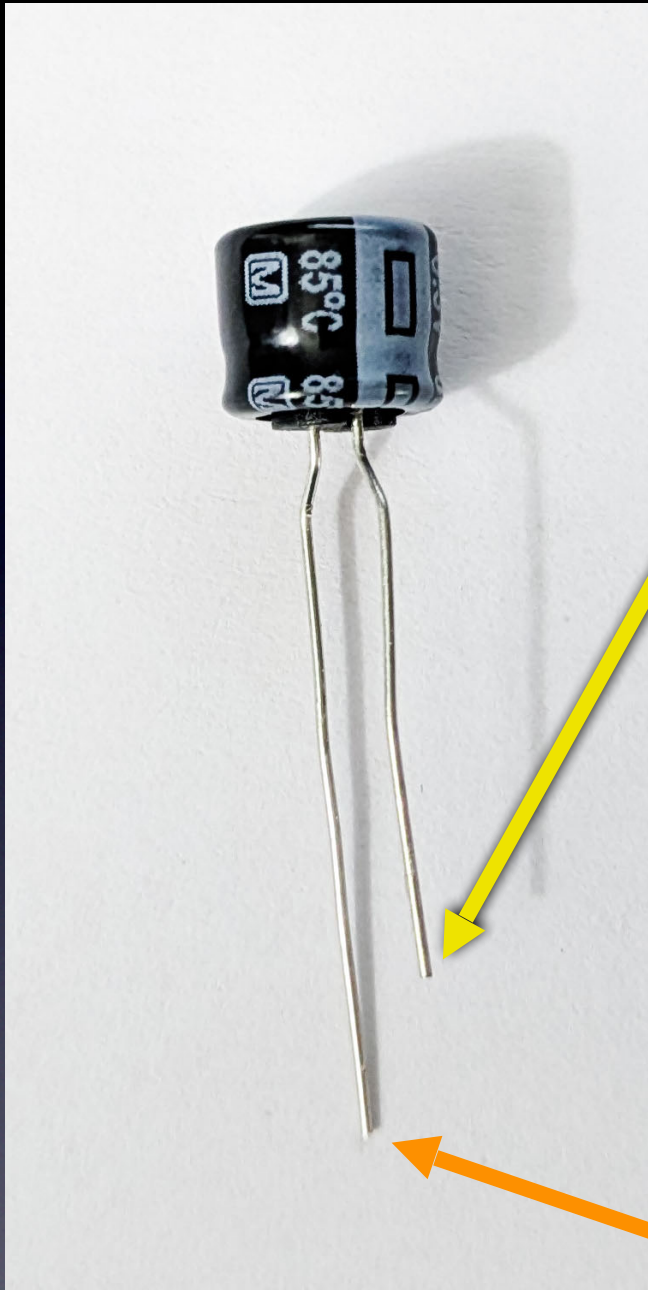

Short Lead is “-”

Capacitor C2 — Long Lead is “+”

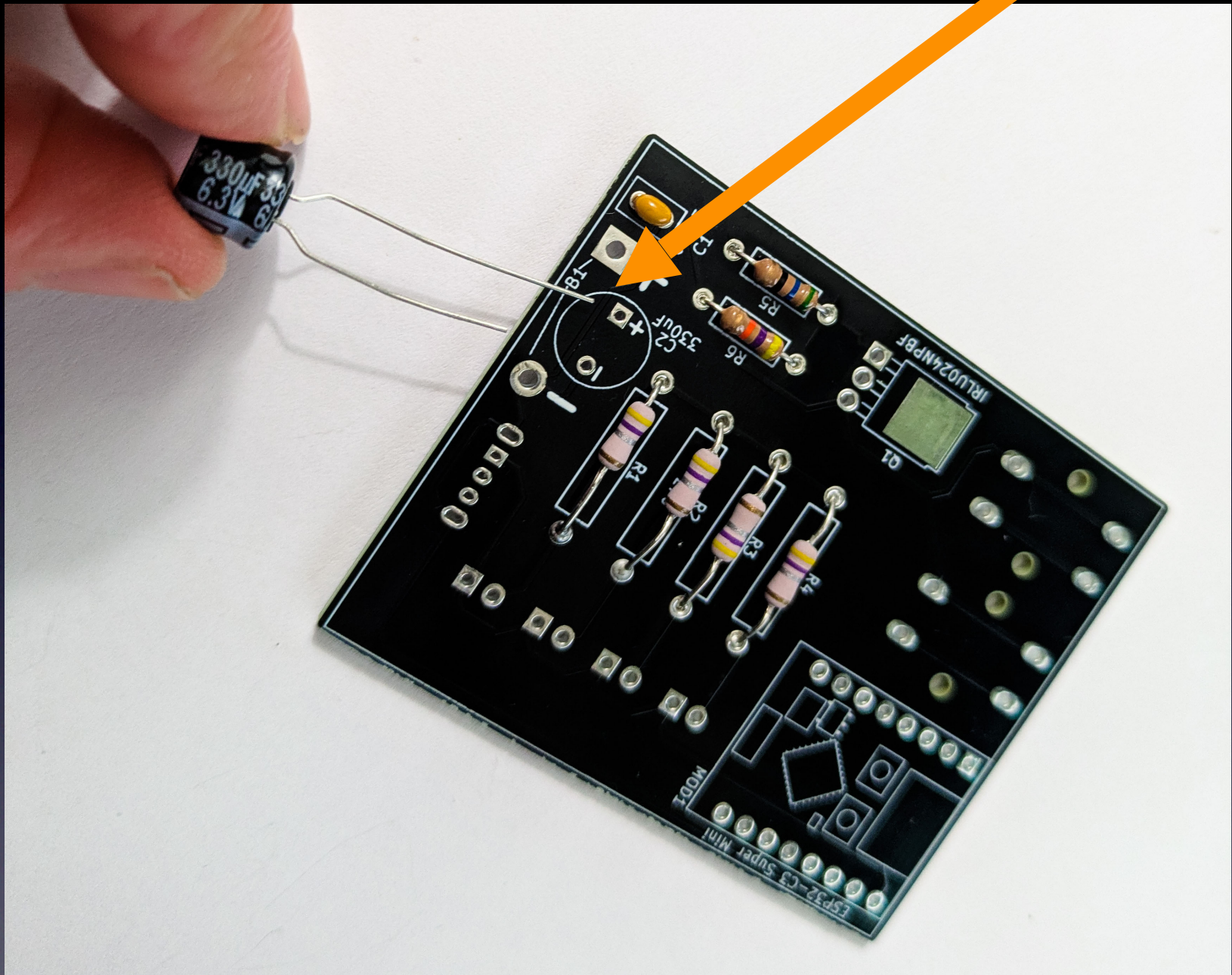

Capacitor C2 — Long Lead is “+”

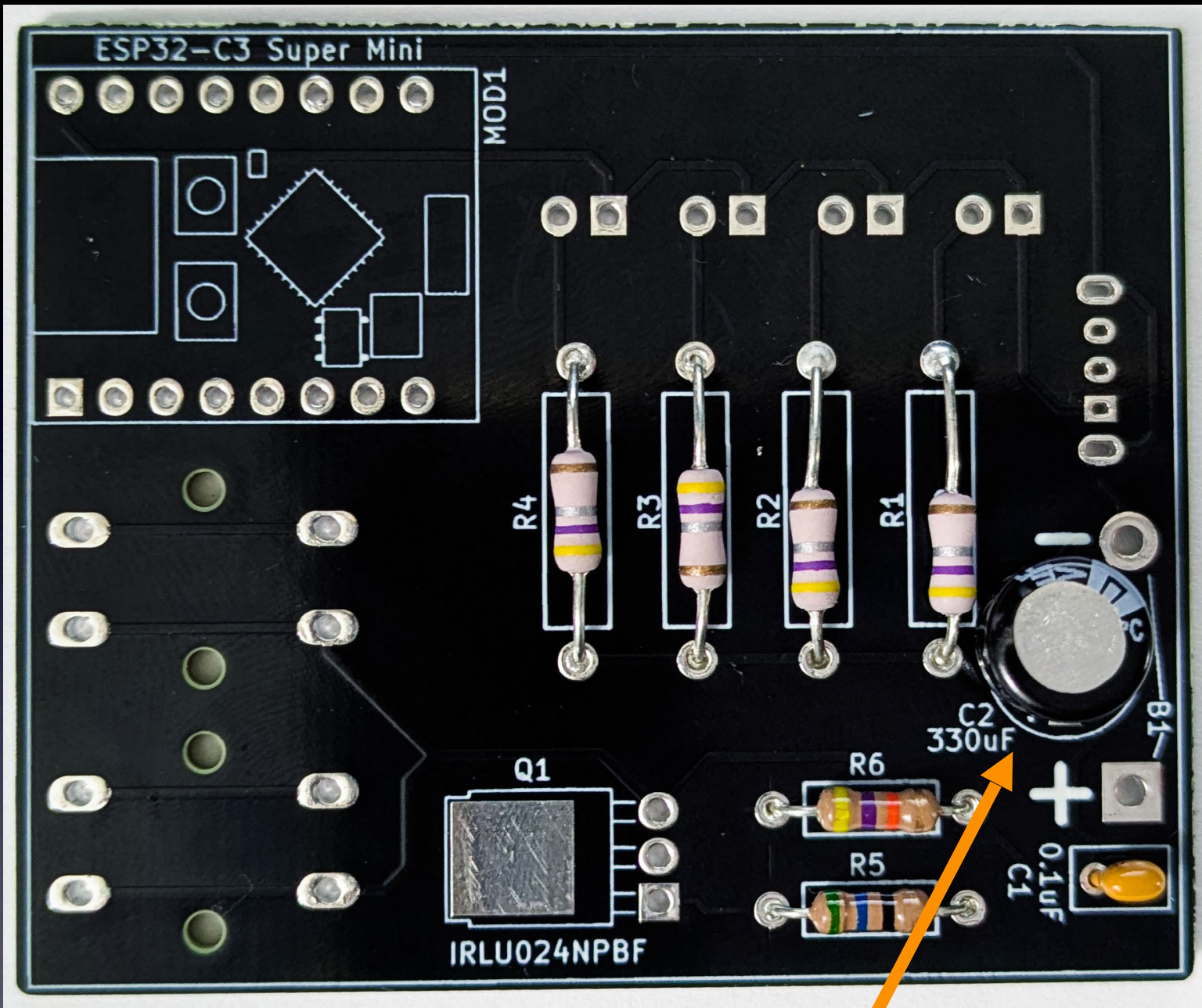

Capacitor C2

NOTE:
Q1 may also be
DOU90N02 or NCE3080IA

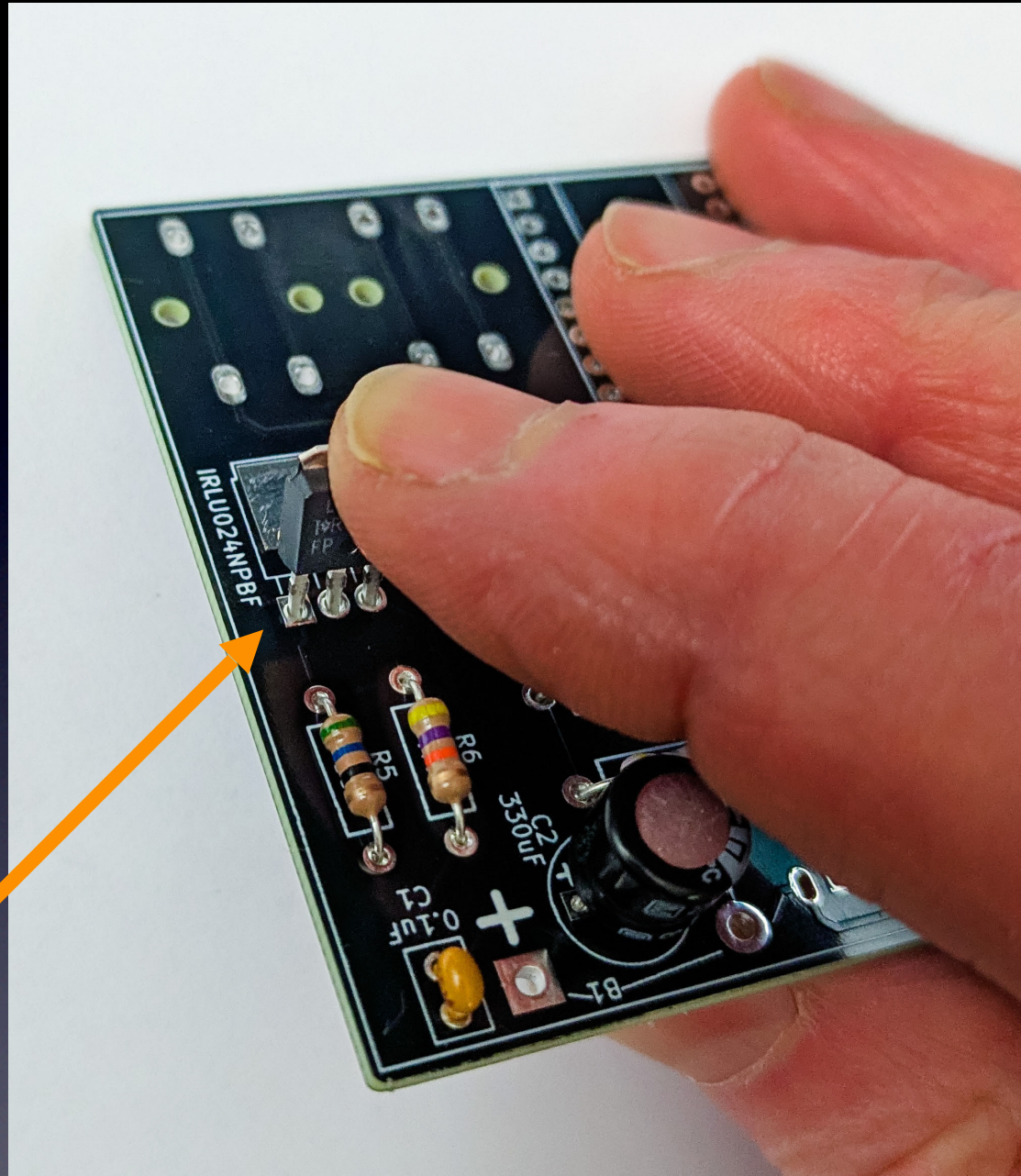

Transistor Q1 — put in place, ready to bend

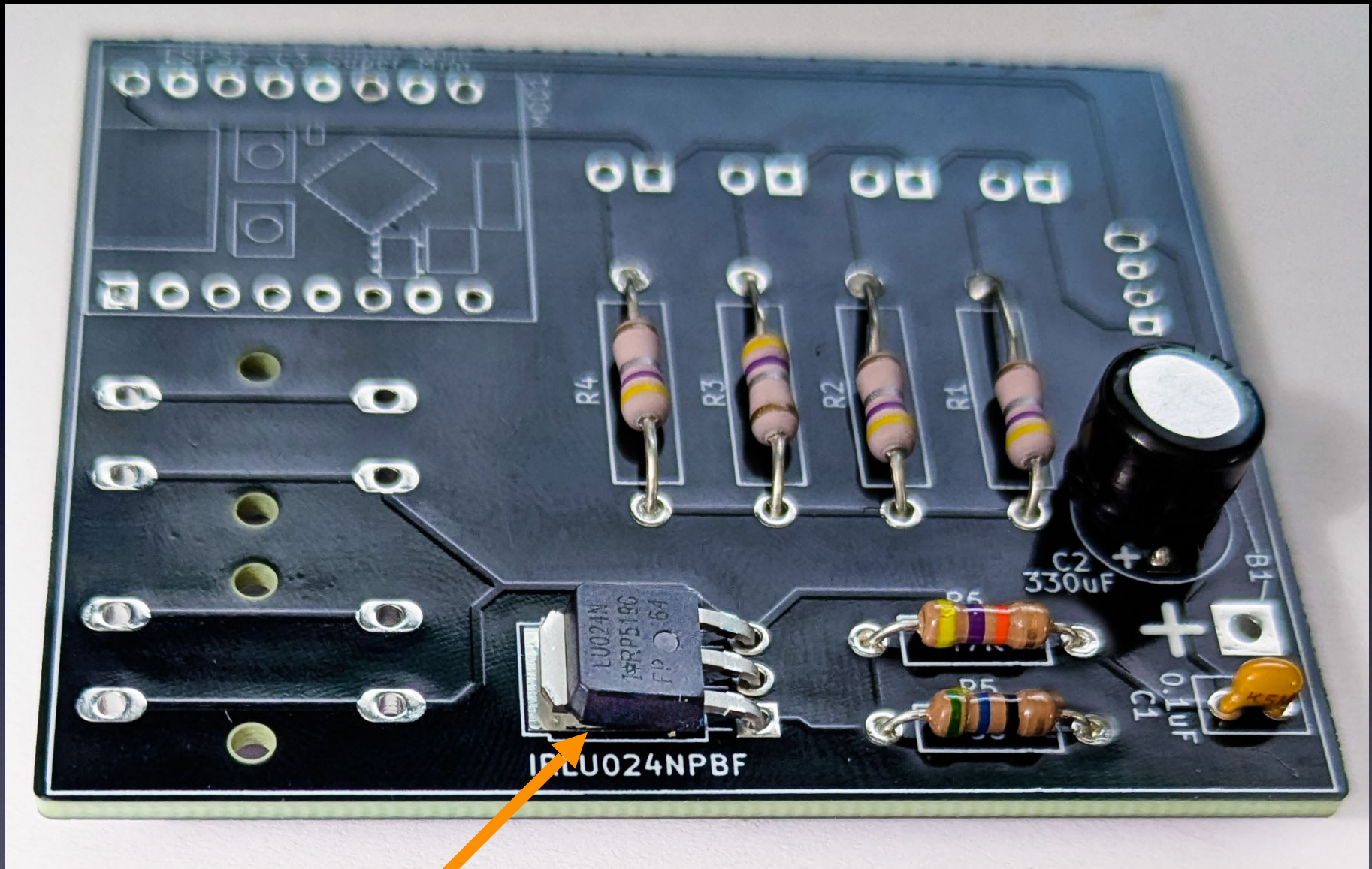

Transistor Q1 — bent down

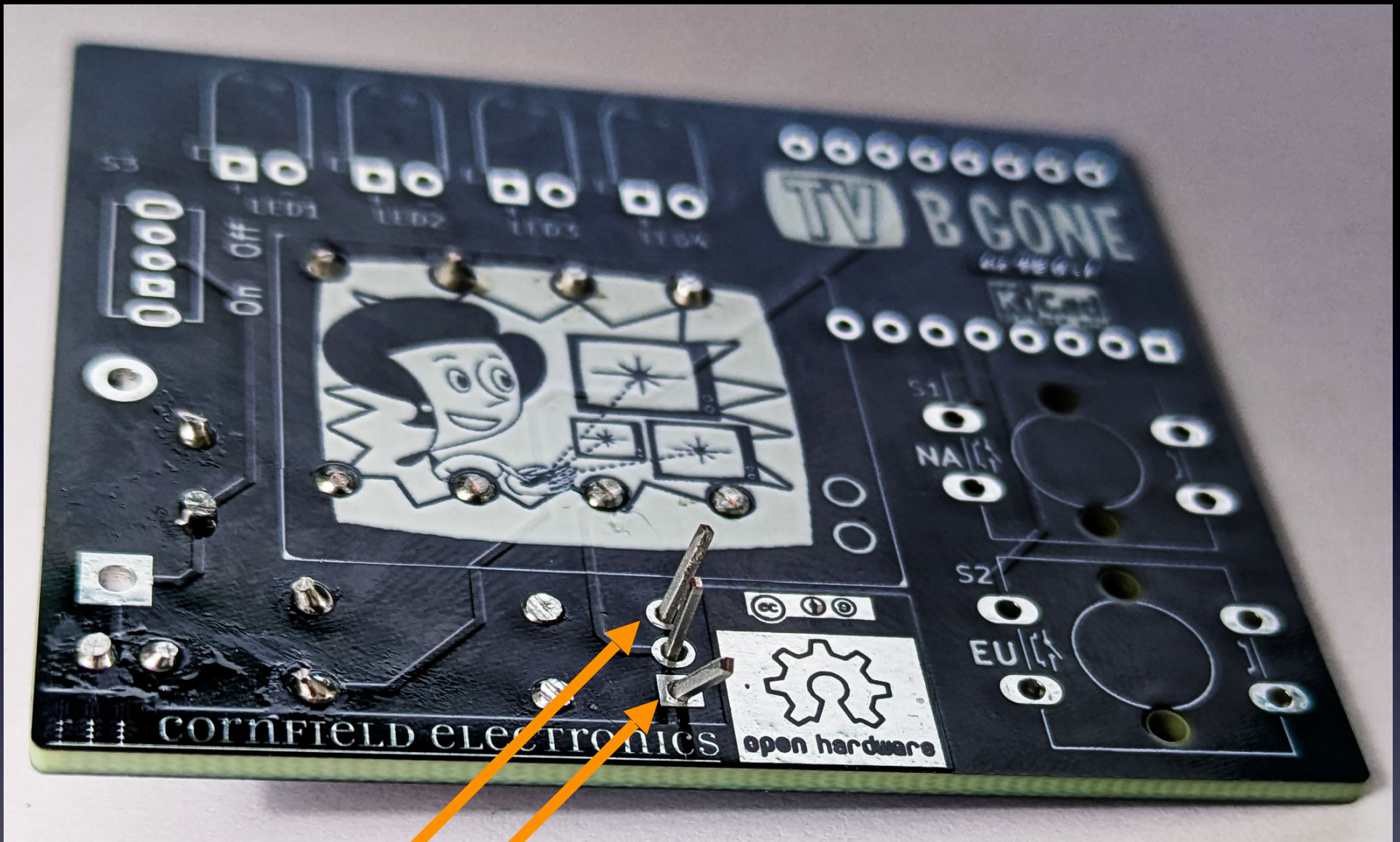

Transistor Q1 — 2 outside leads bent as a “V”
Ready to solder

USB

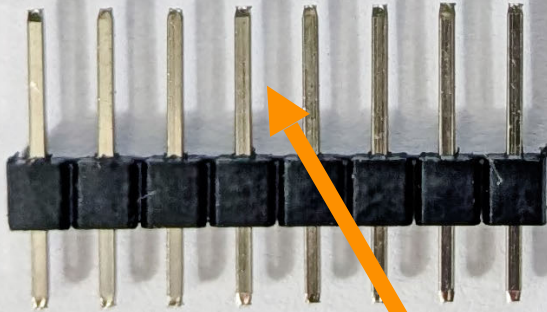
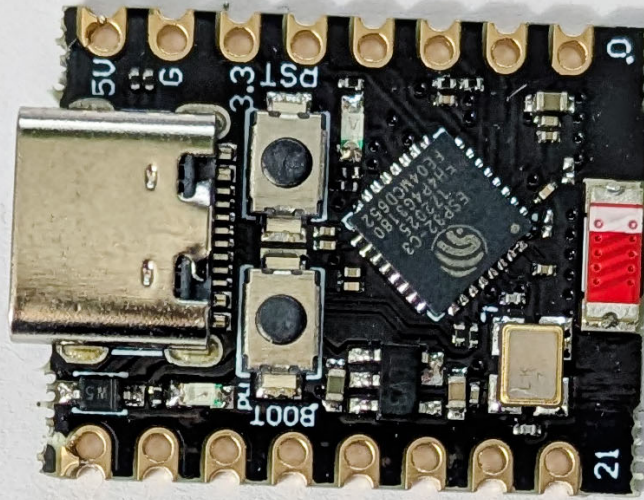

**MOD1 — notice long leads and short leads
DO NOT SOLDER YET!**

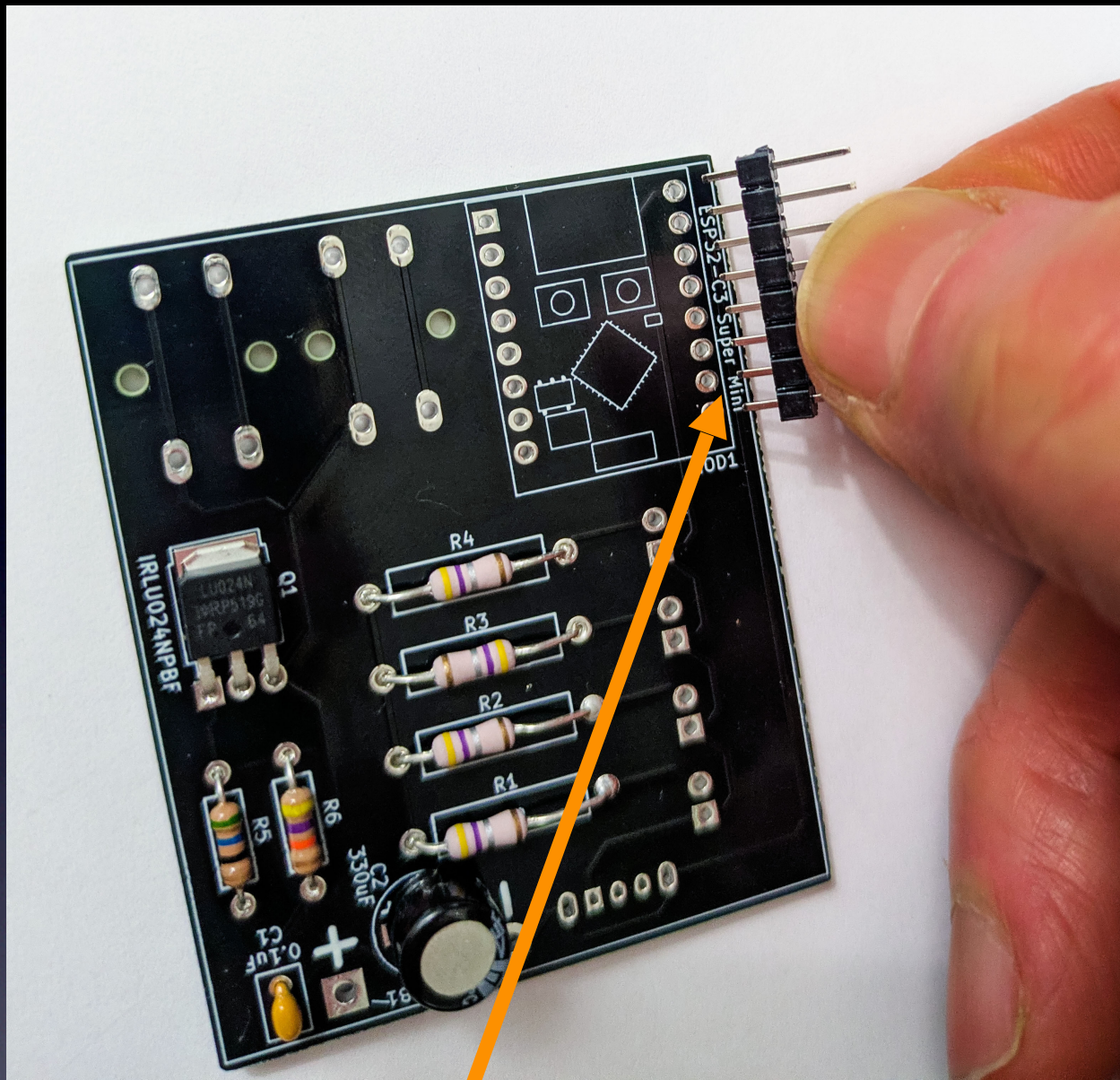

MOD1 — short pins go into PCB
(long leads stick up, away from PCB)
DO NOT SOLDER YET !

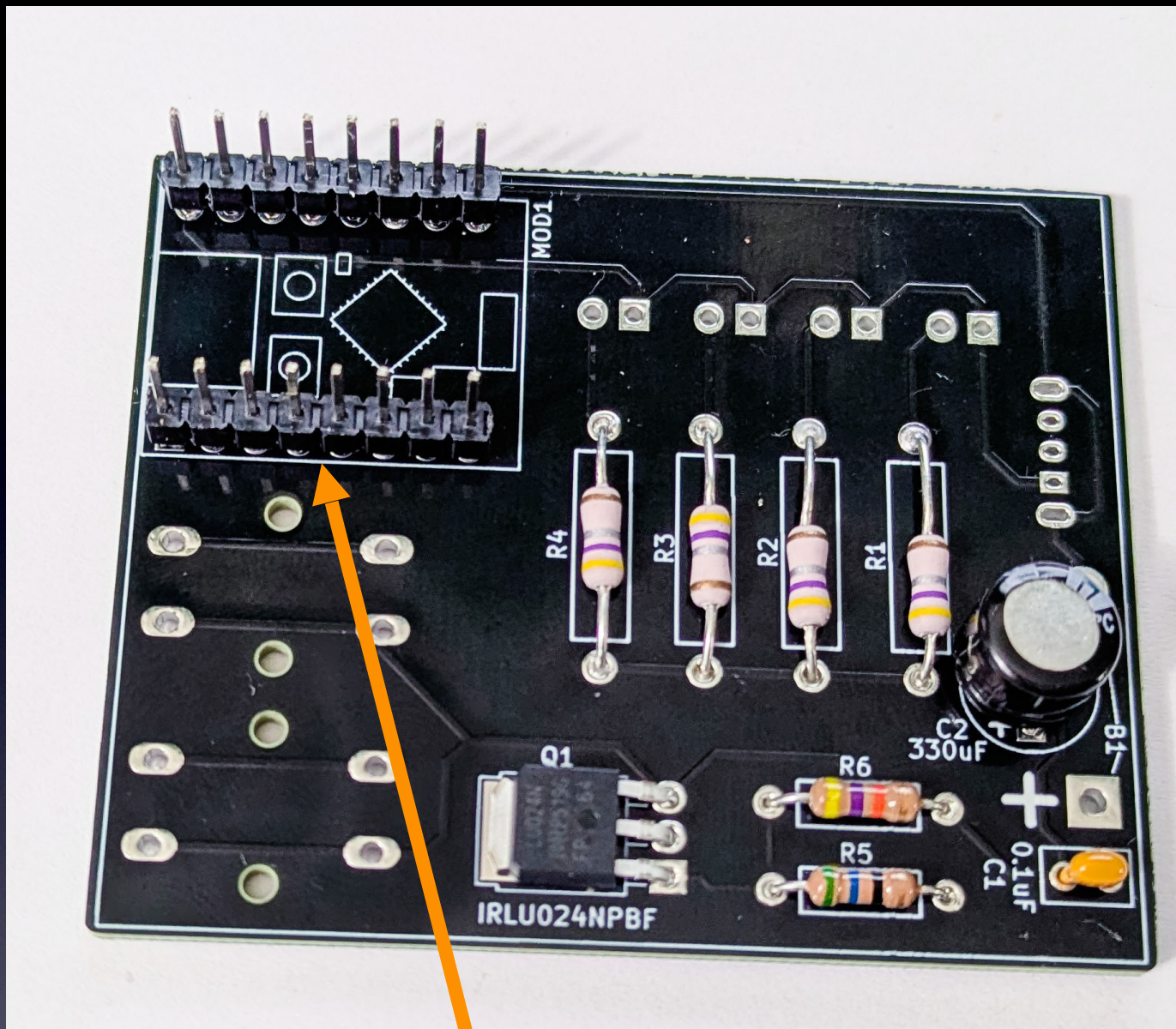

**MOD1 — header pins placed
DO NOT SOLDER YET !**

USB

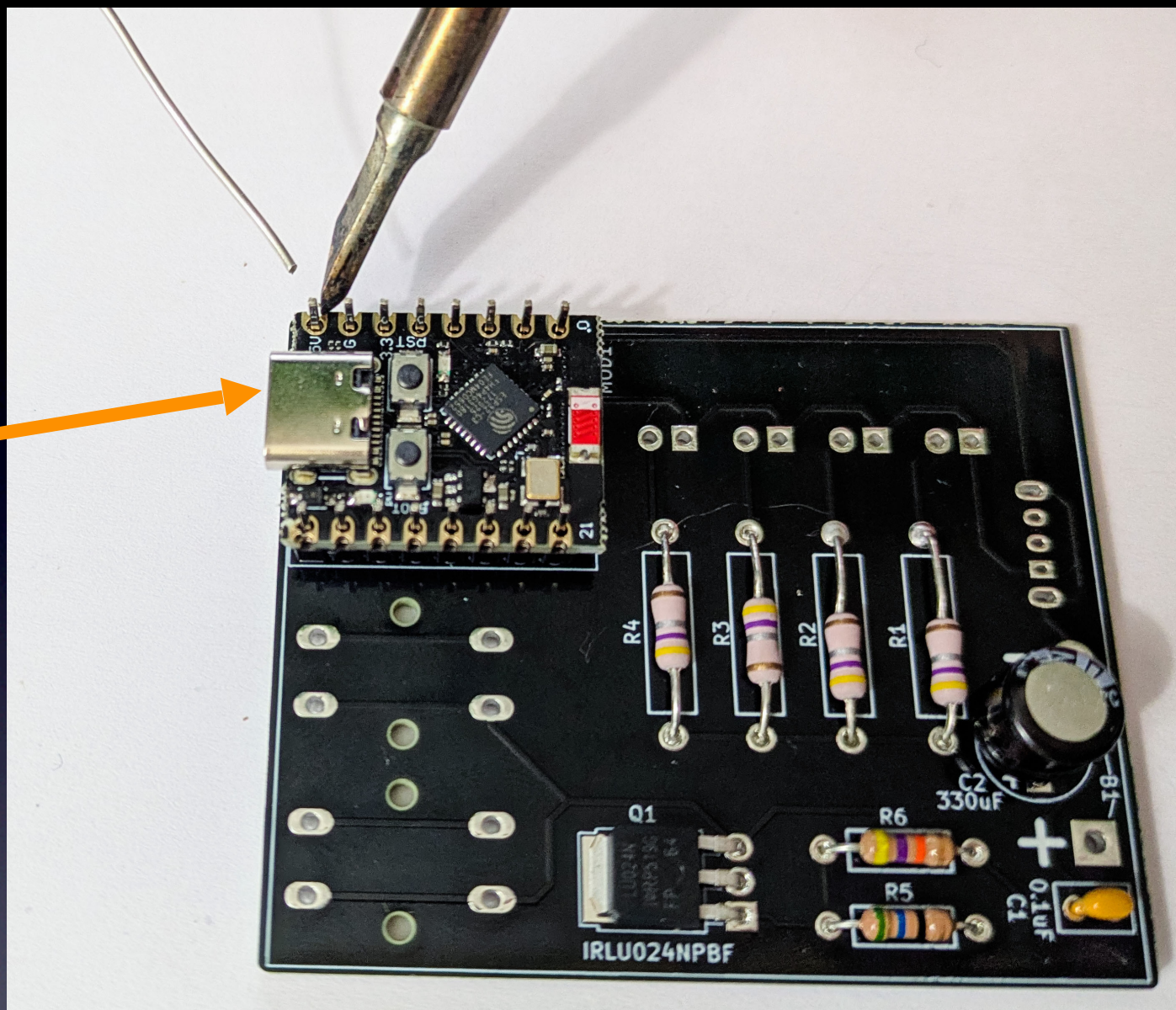

MOD1 — place little board as shown
Solder the pins on the top

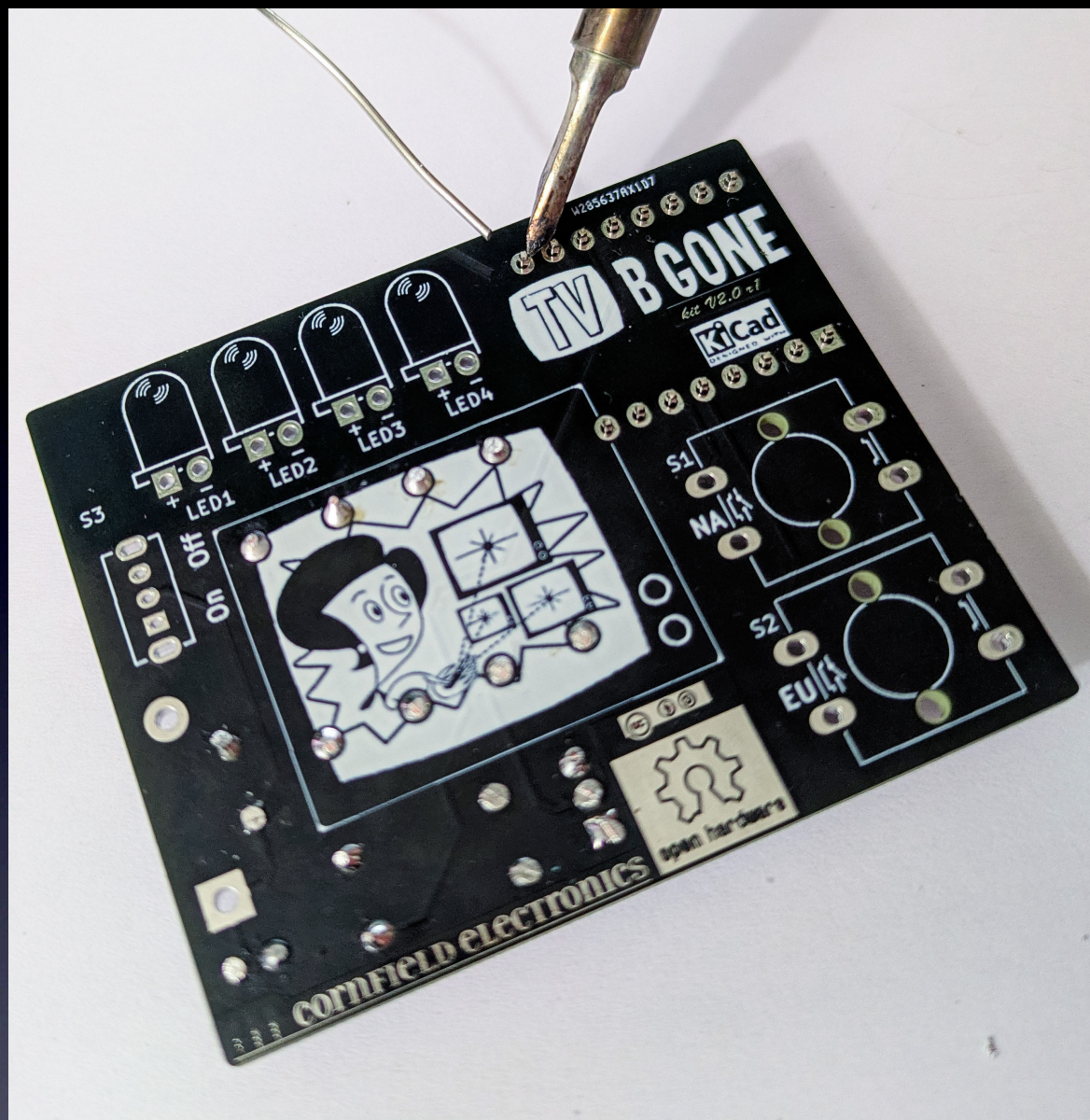

MOD1 — turn board over
Solder the pins on the bottom

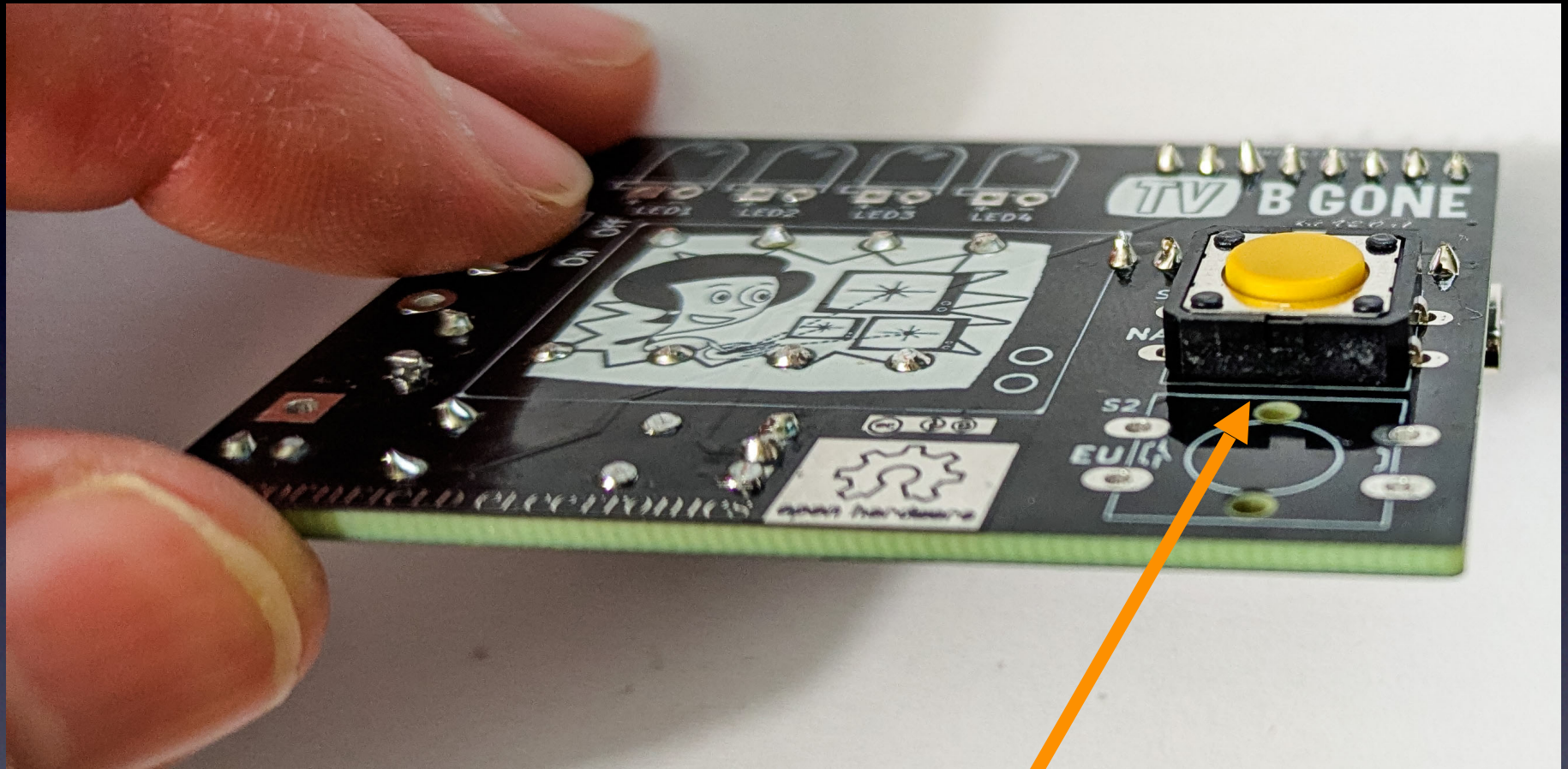

Switch S1

*(It will fit in two ways
— either way is fine)*

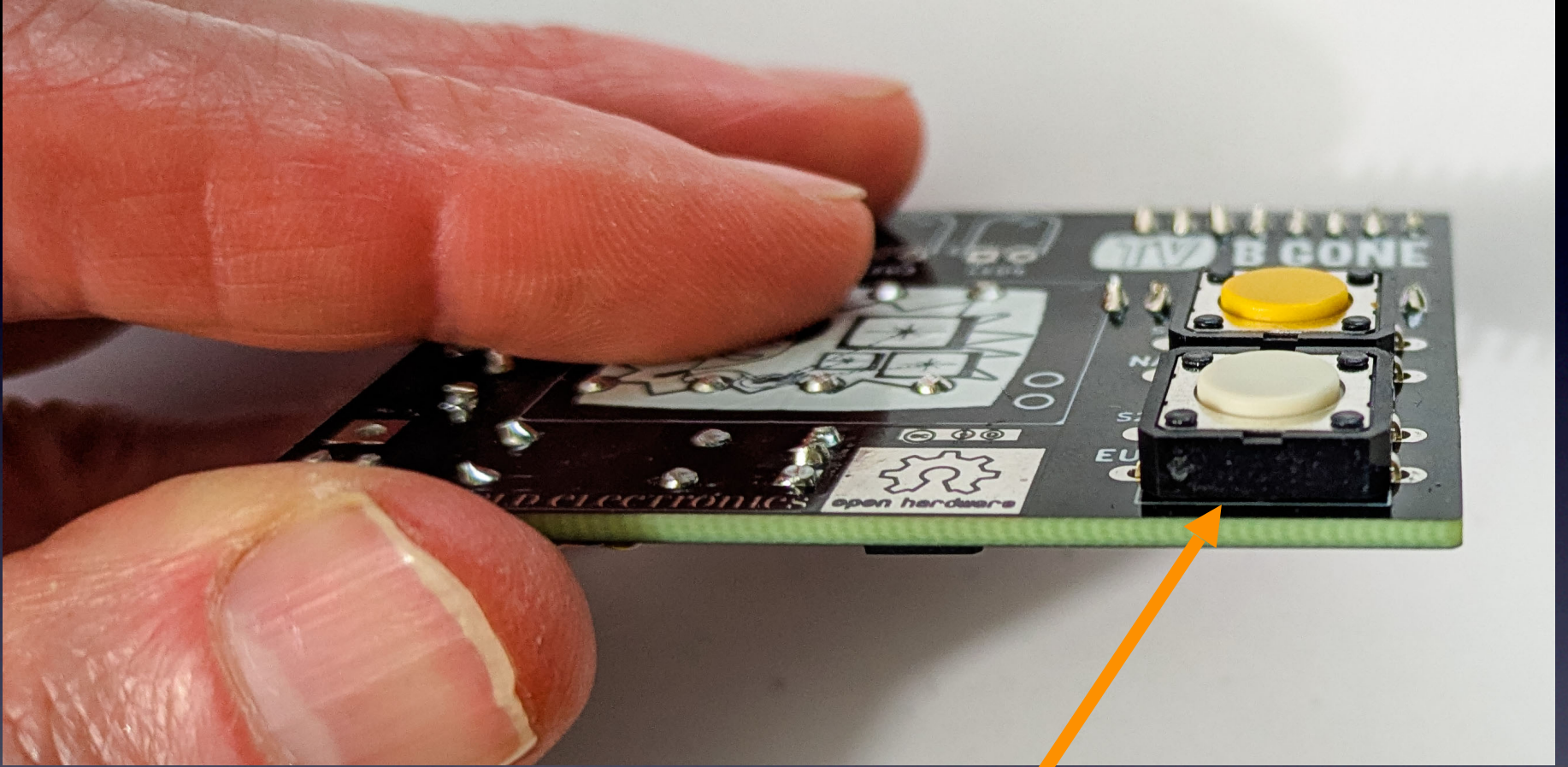

Switch S2

*(It will fit in two ways
— either way is fine)*

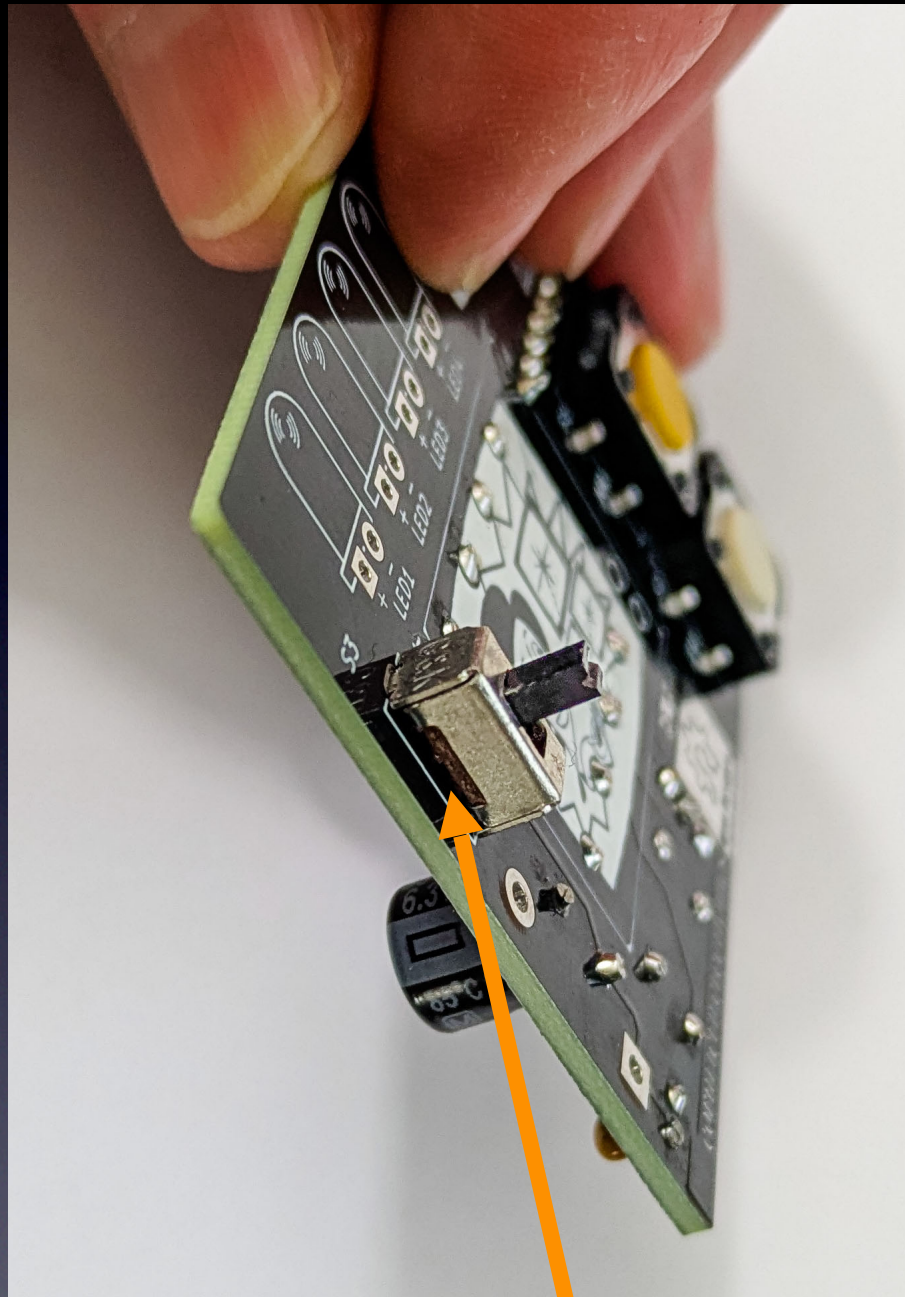

Switch S3

(Direction does not matter)

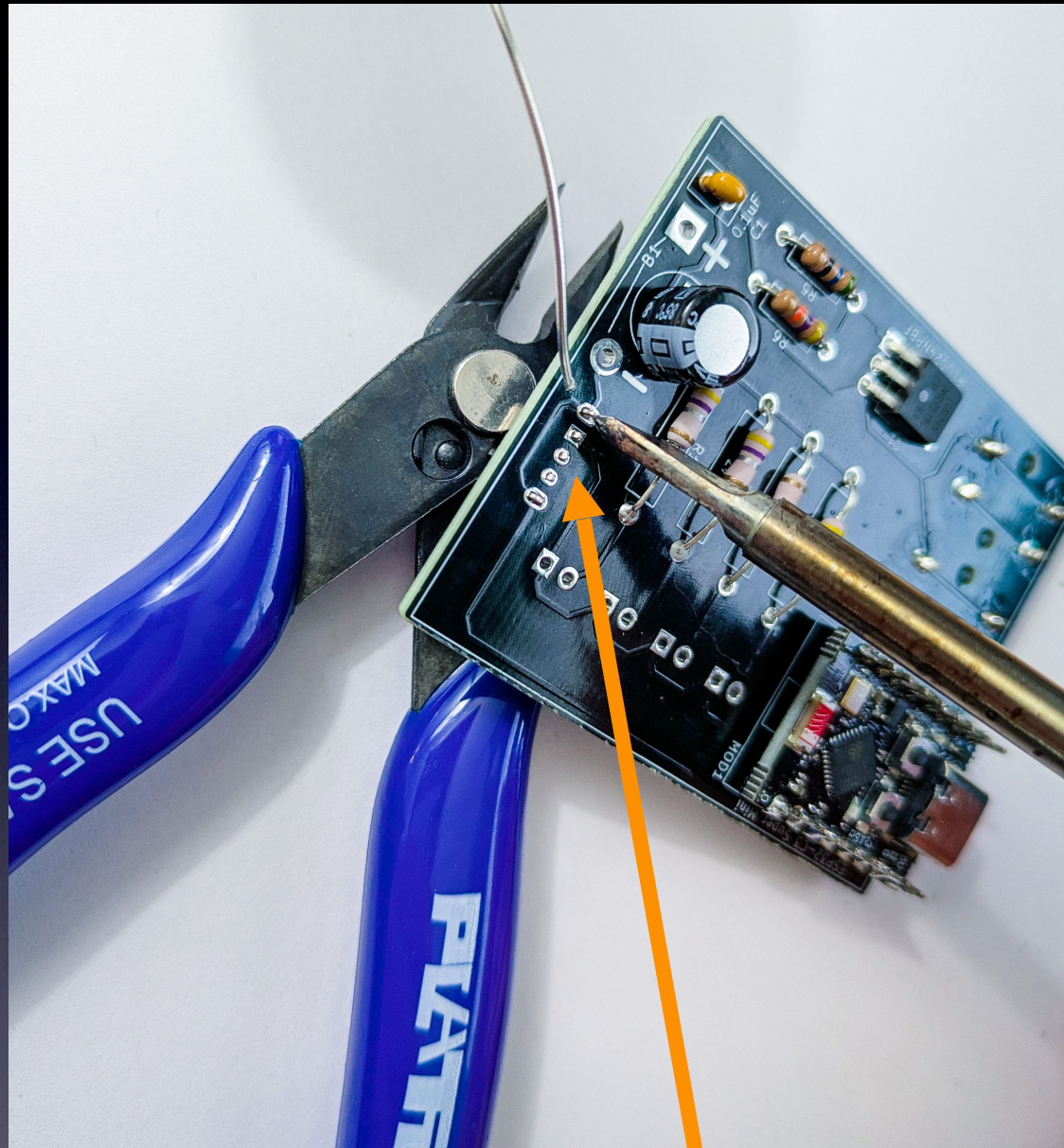

Switch S3 — resting on wire cutters to solder

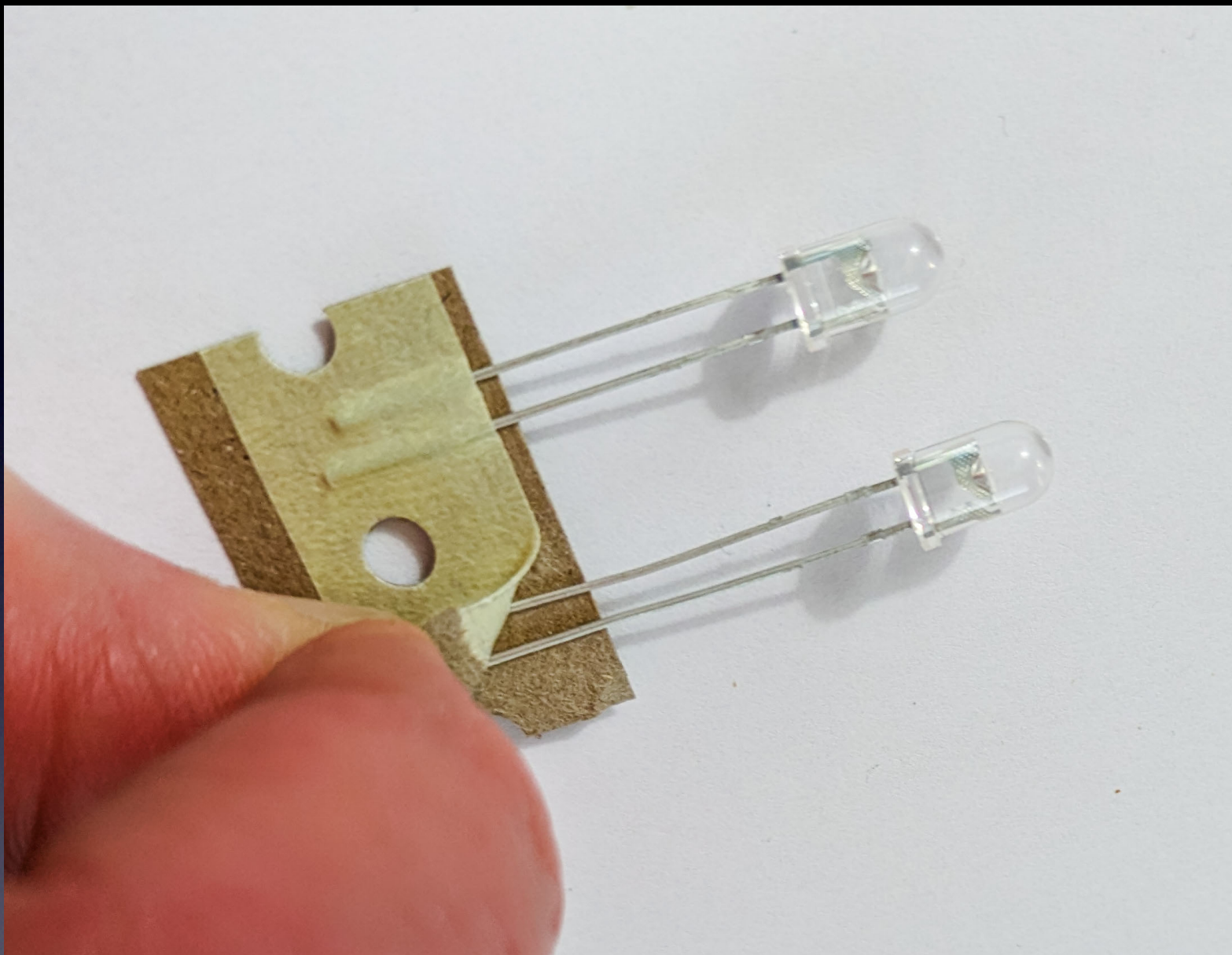

LED1 - LED2 — peel off tape



Short Leads are “-”

LED1 - LED2 — Long Leads are “+”

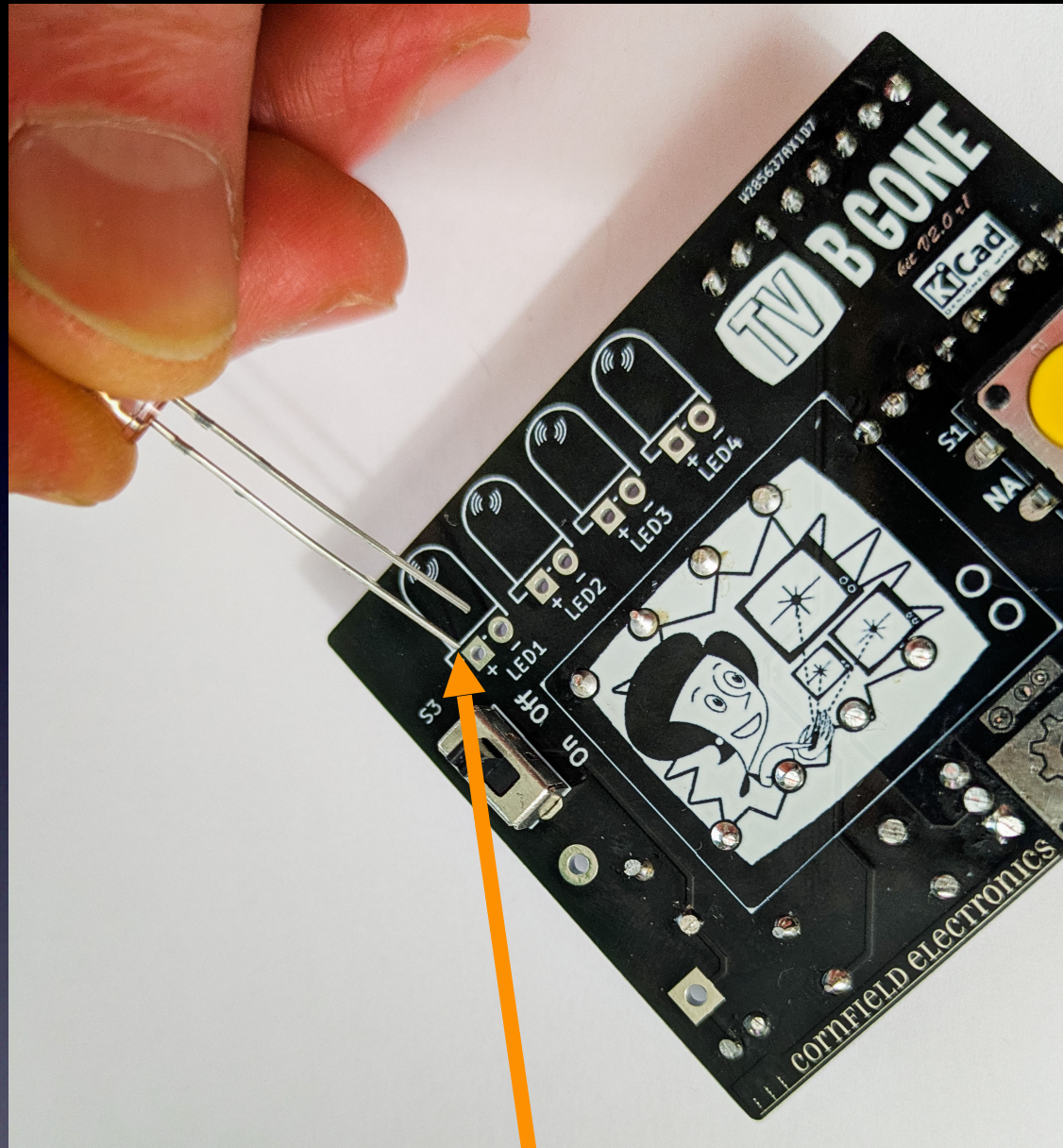

LED1 - LED2 — Long Leads are “+”

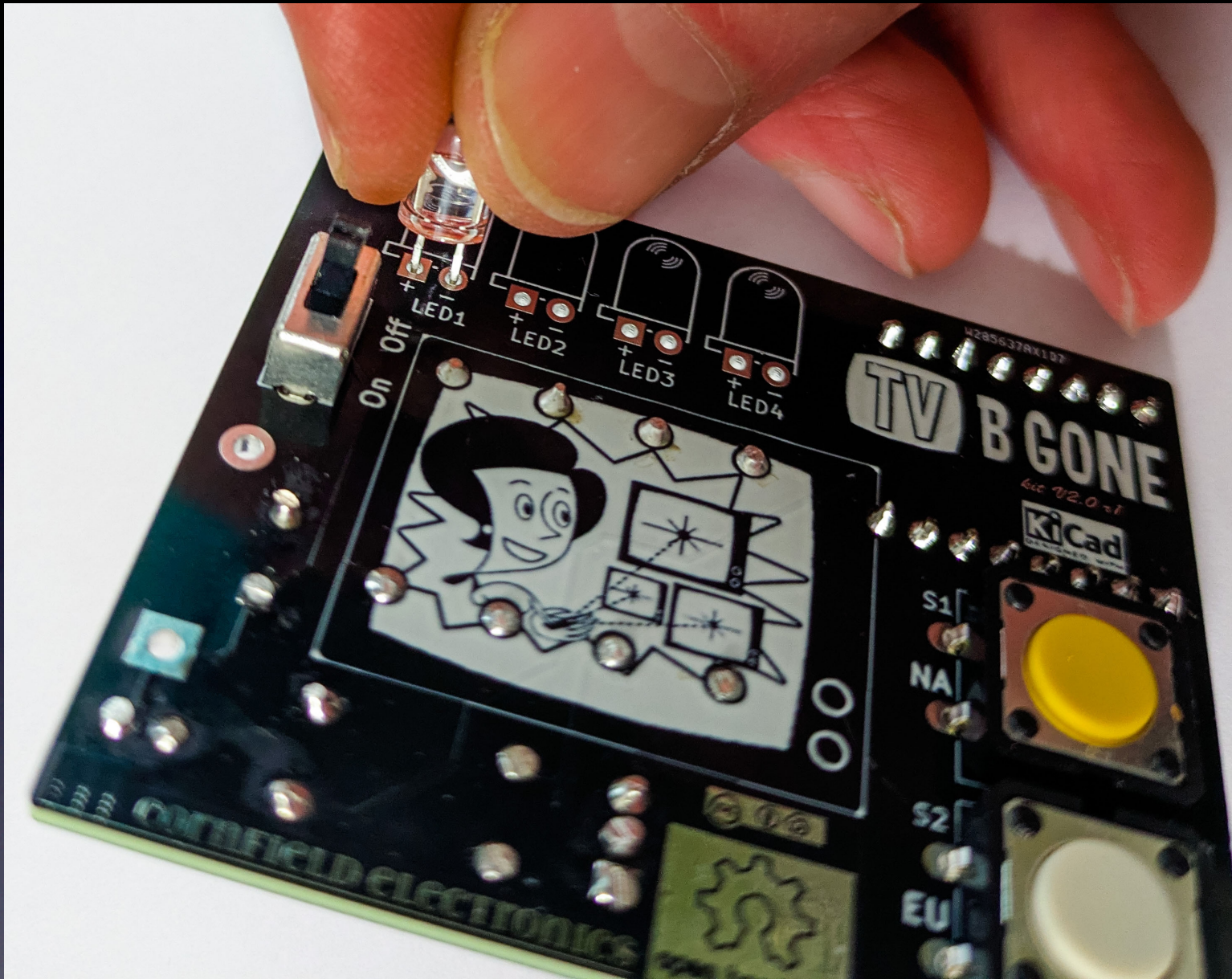

LED1 — put in place, ready to bend

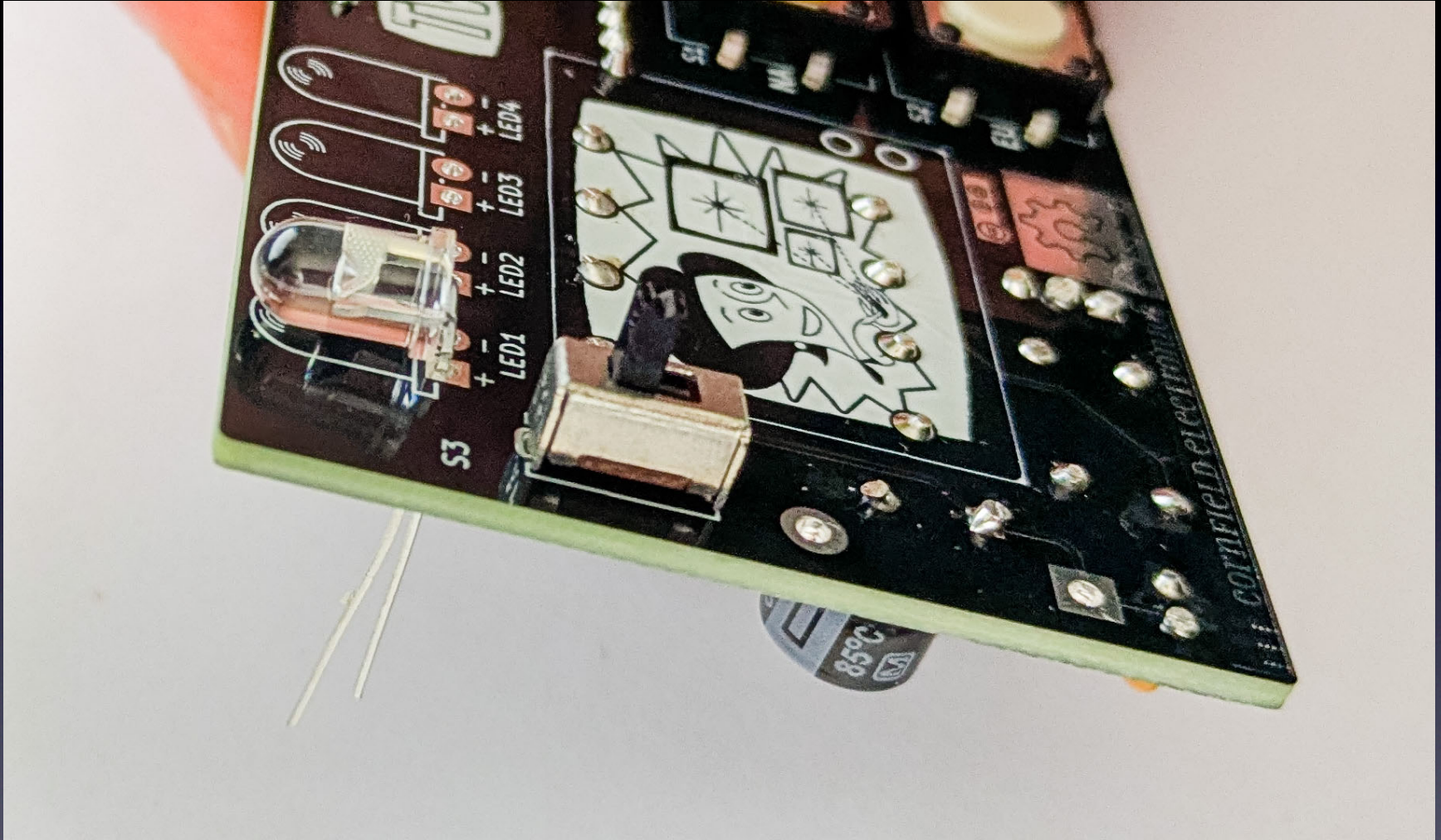

LED1 — bent down

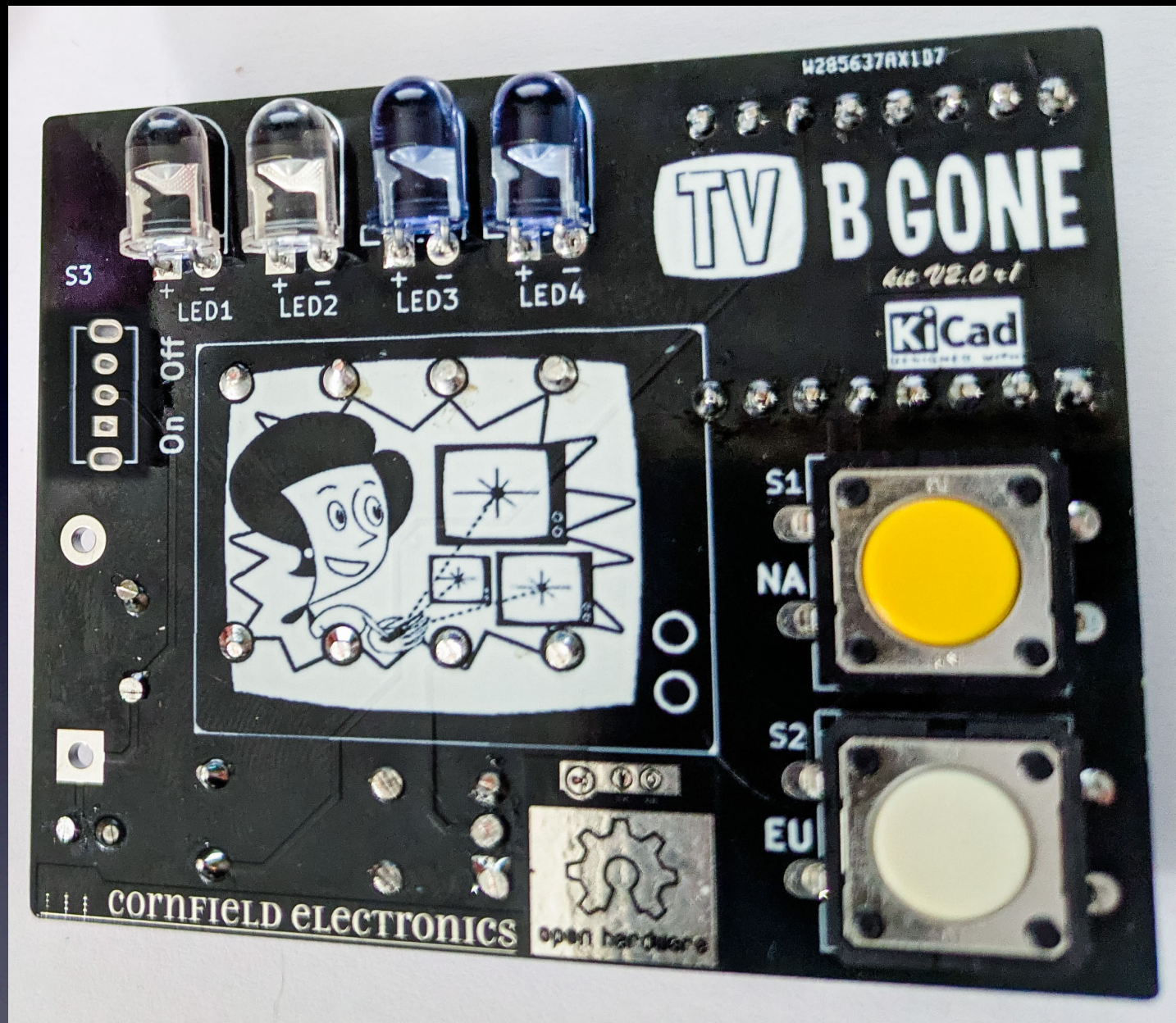

LED1 - LED4 — all soldered in place

switch OFF

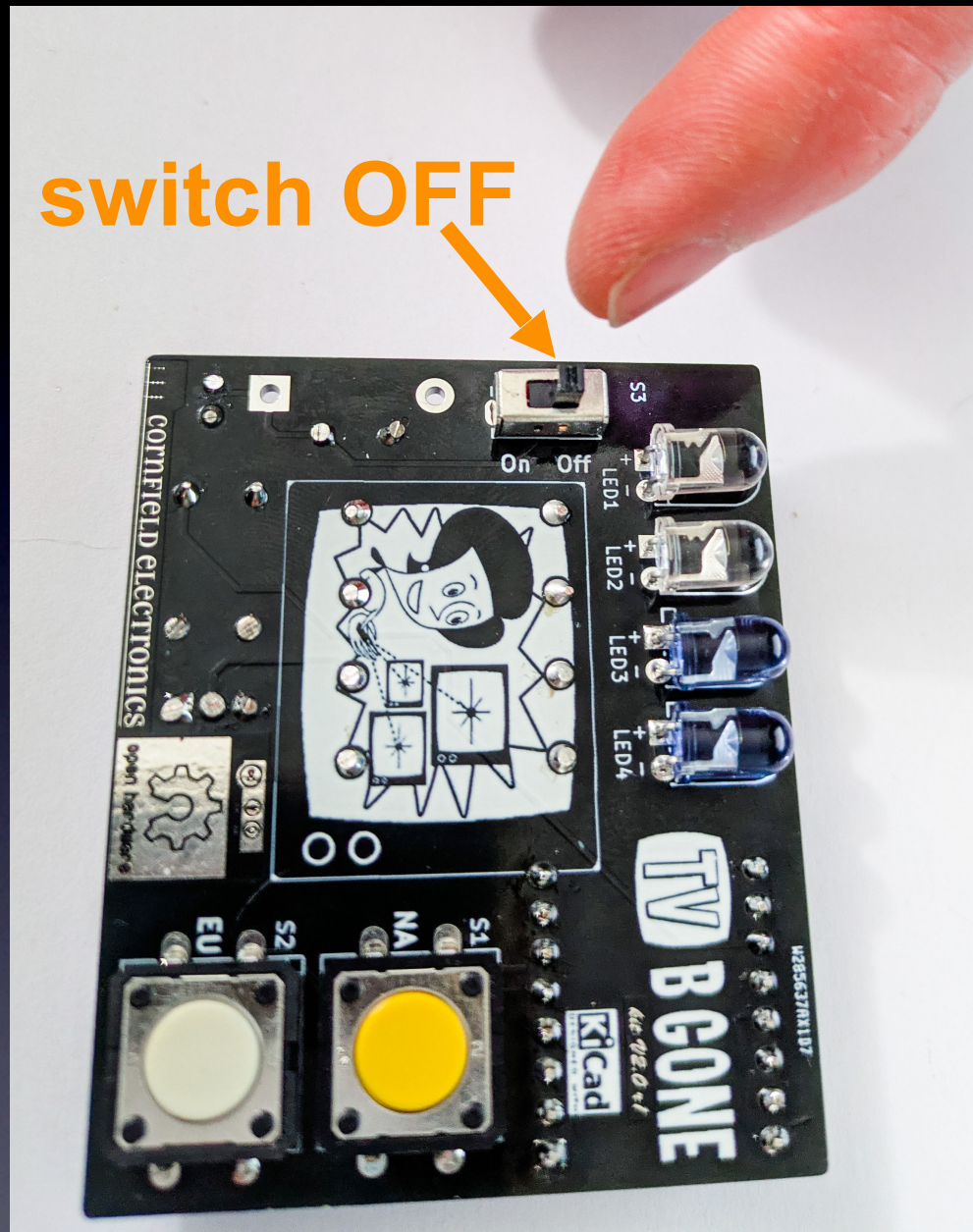

Get ready for testing !

**Batteries
in
Holder**

**IMPORTANT:
Use Alkaline
AA batteries**

other kinds of AA batteries
will not work



Get ready for testing !



Place
battery
holder
in place

Get ready for testing !

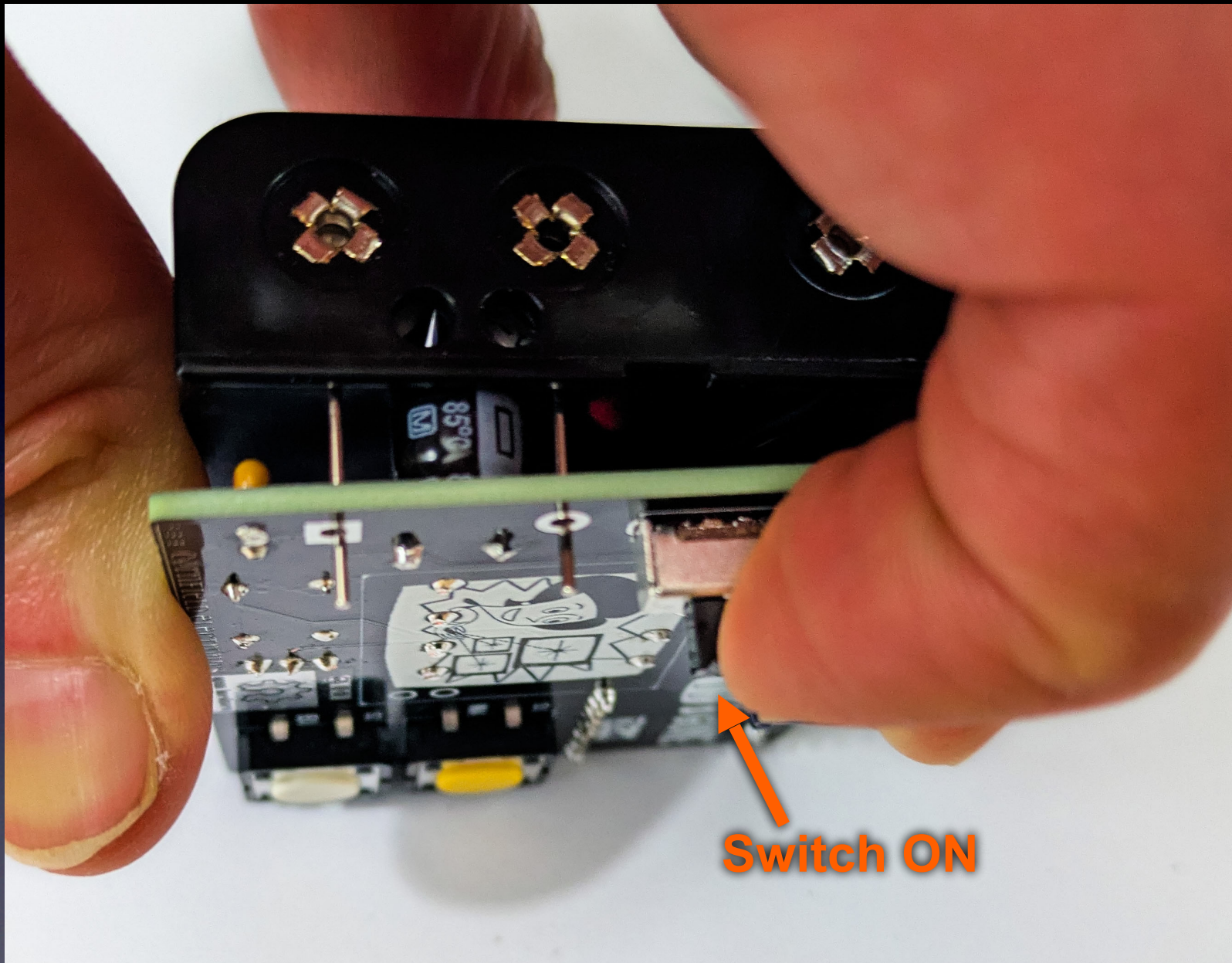

Testing !

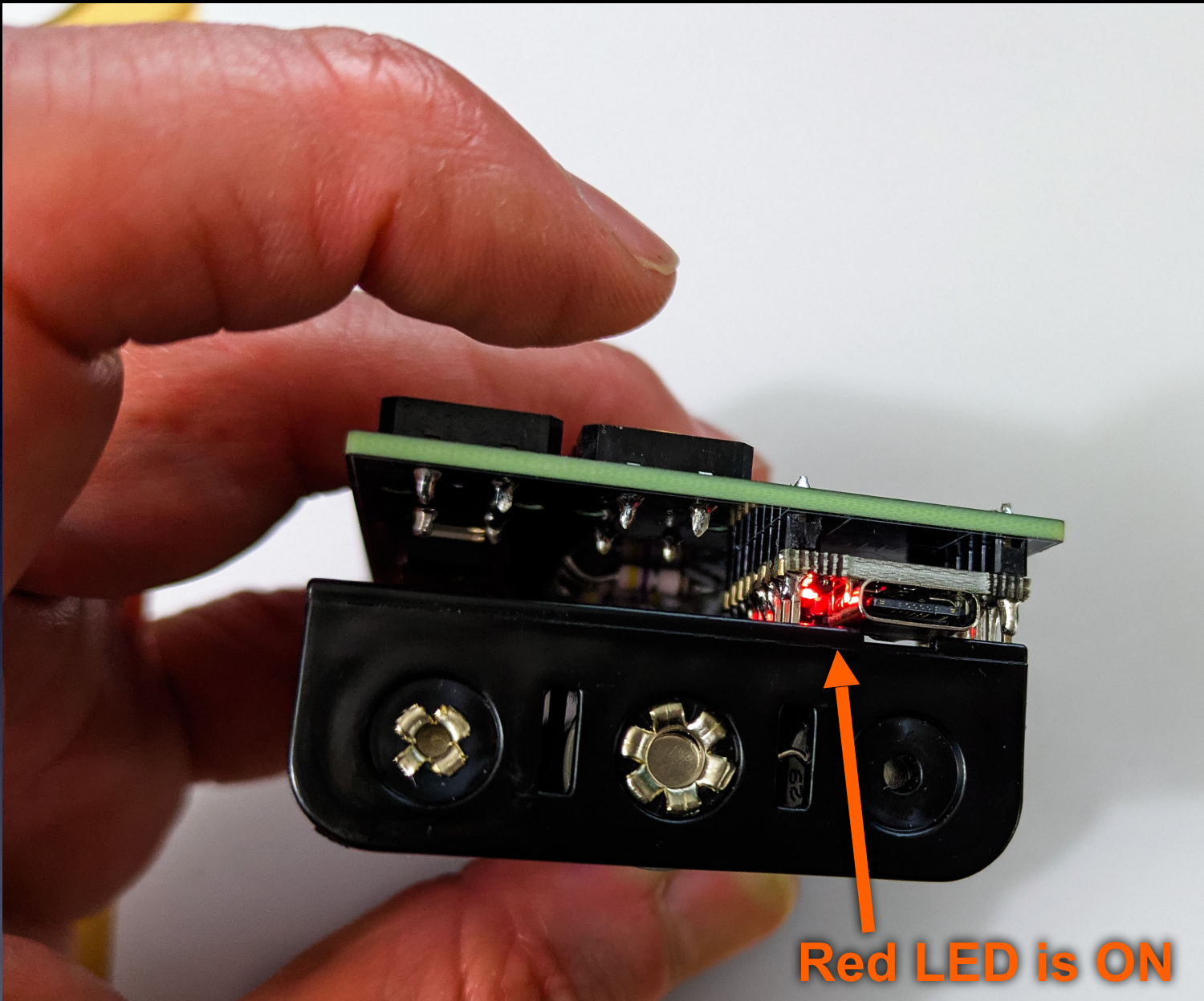

First test: Red LED is on

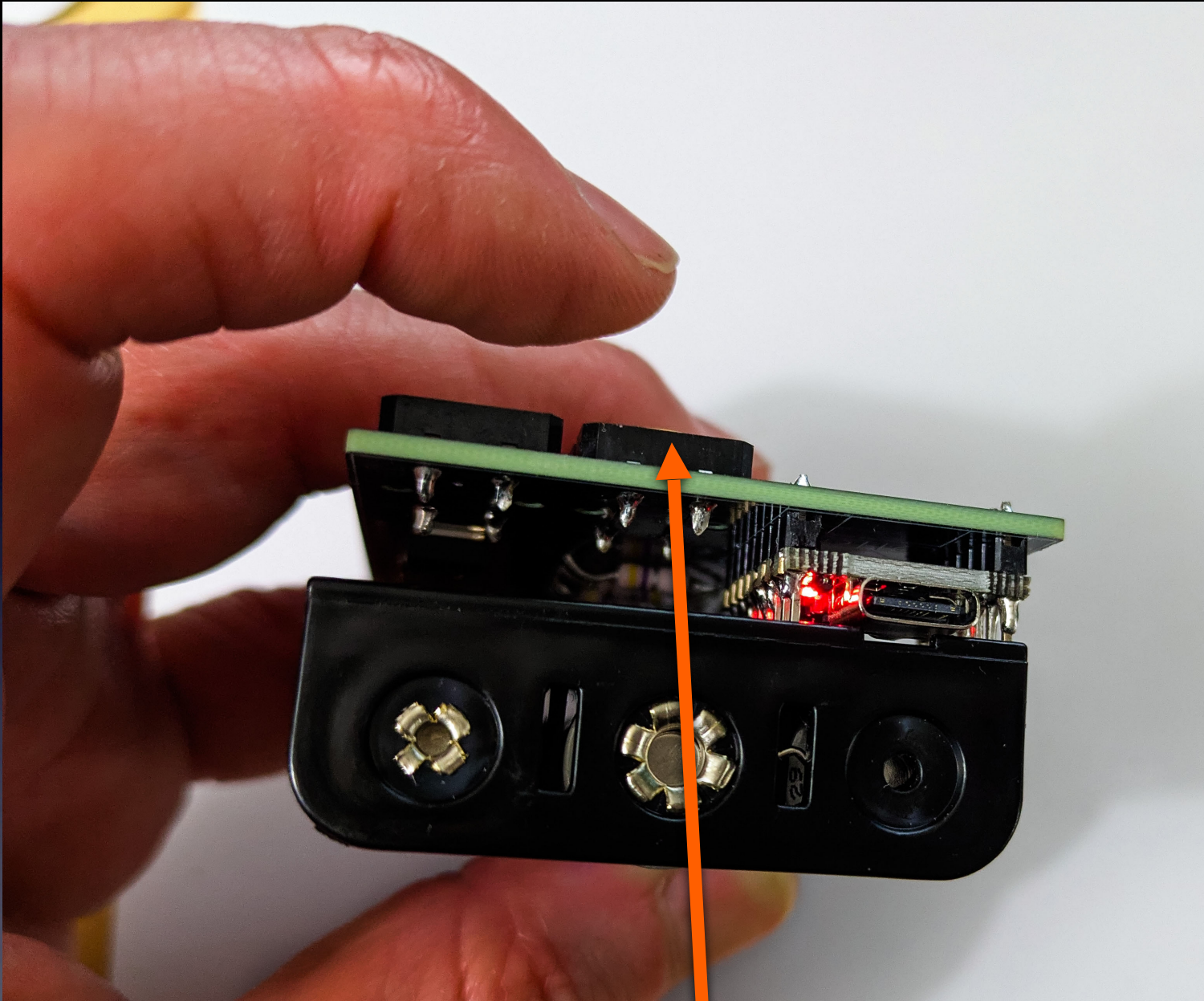

Second test - a): push S1 (or S2) button

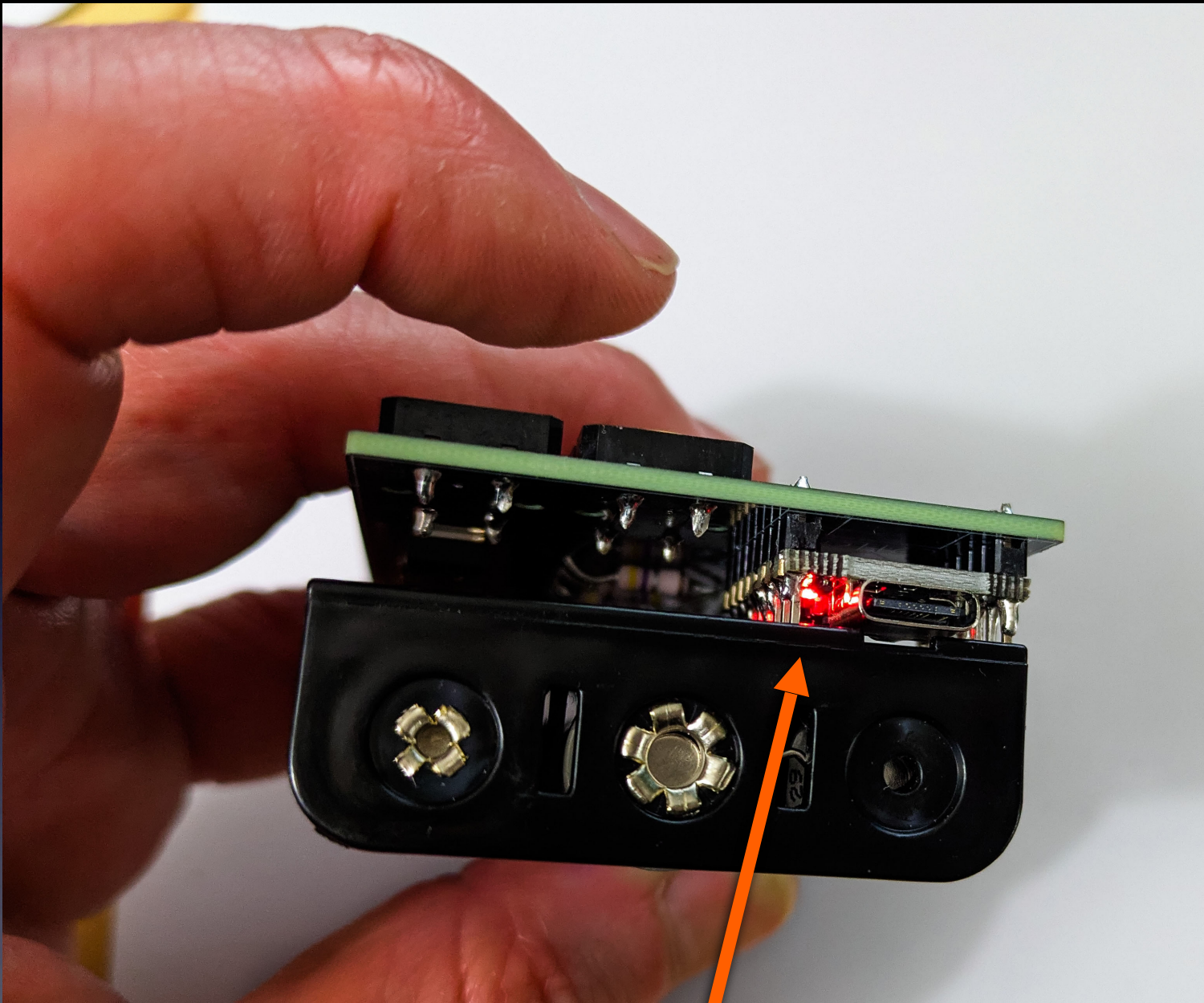

Second test - b): Blue LED blinks

Point IR LEDs
directly
into
phone camera
lens



IR LEDs flicker
(using
front-facing
phone camera)

Third test: all 4 IR LEDs flicker

If the three tests are good,
it works!

Or you start debugging.

If you used any *flux paste* for re-working problems



The bottom of the PCB will be sticky from the flux

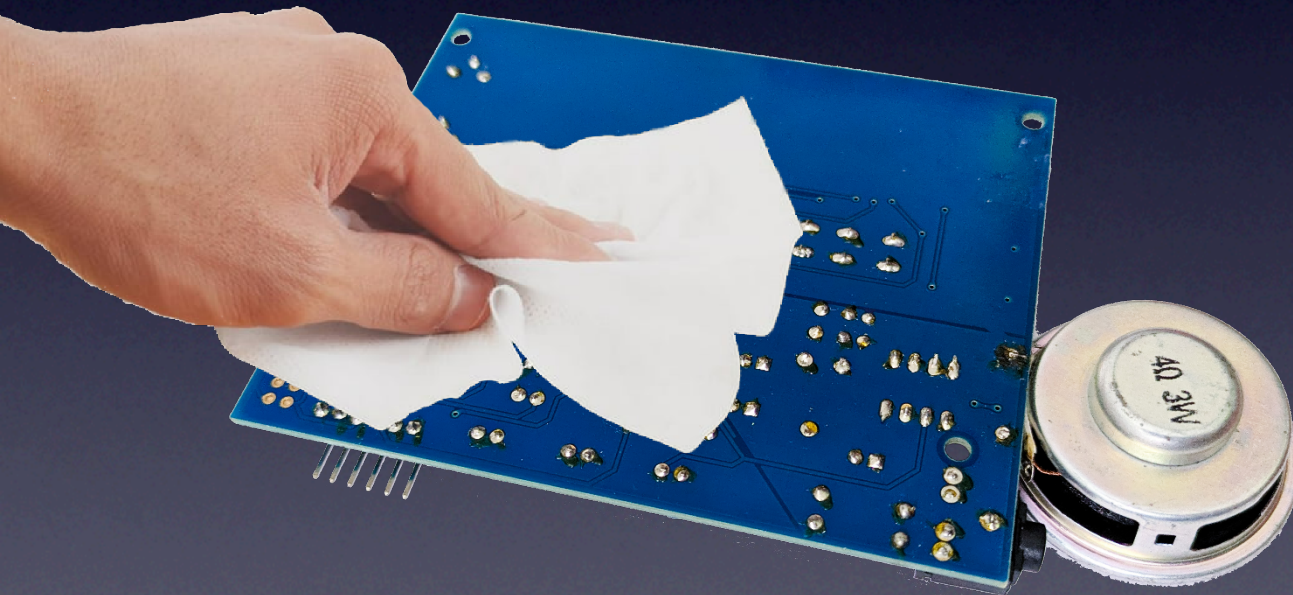

You can clean it with a cloth wet with *Isopropyl Alcohol*

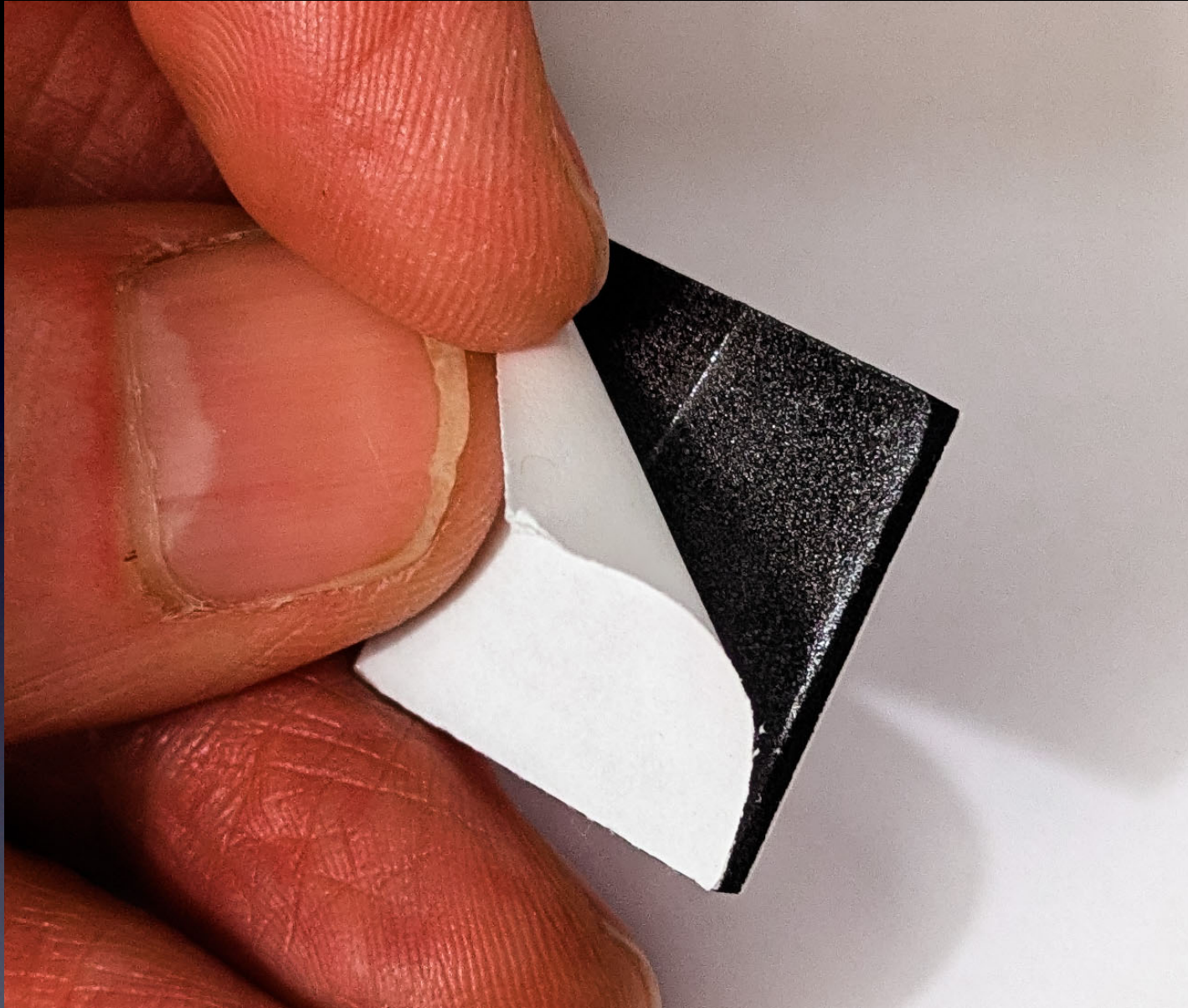

Peel back one side of double-sided foam tape

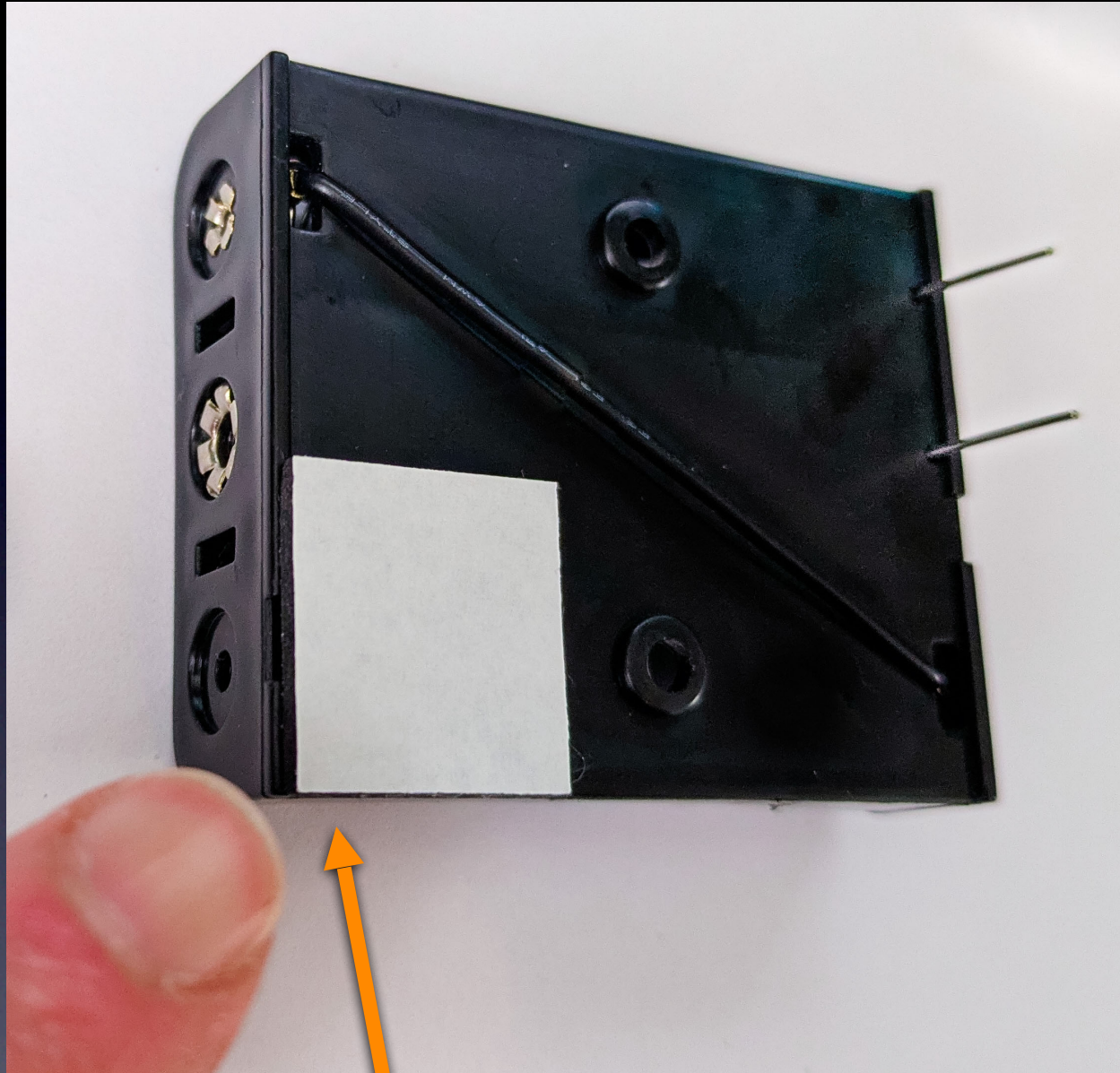

Stick foam in *this* corner of battery pack



Peel back the other side of foam tape

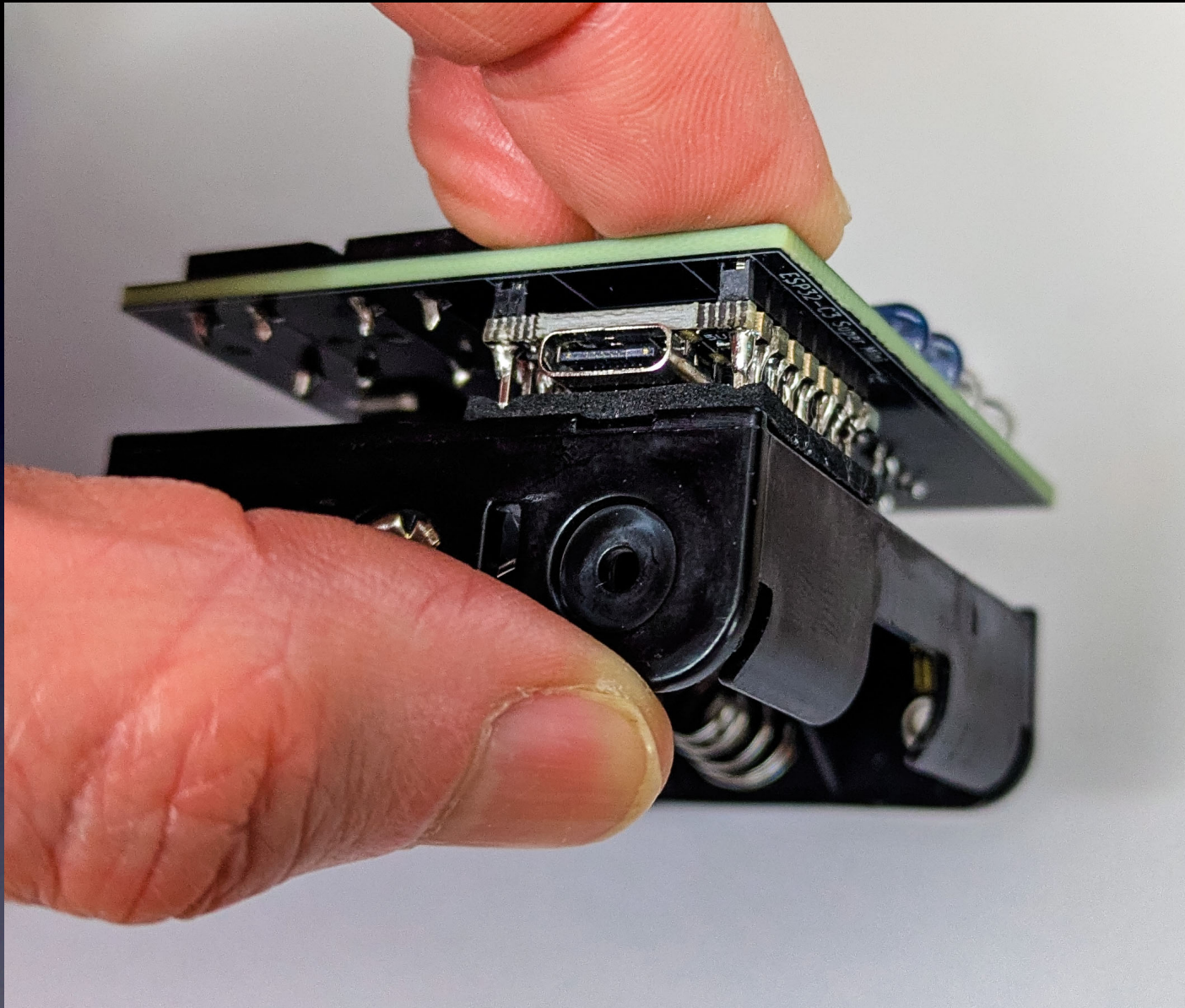

Squeeze foam tape into MOD1

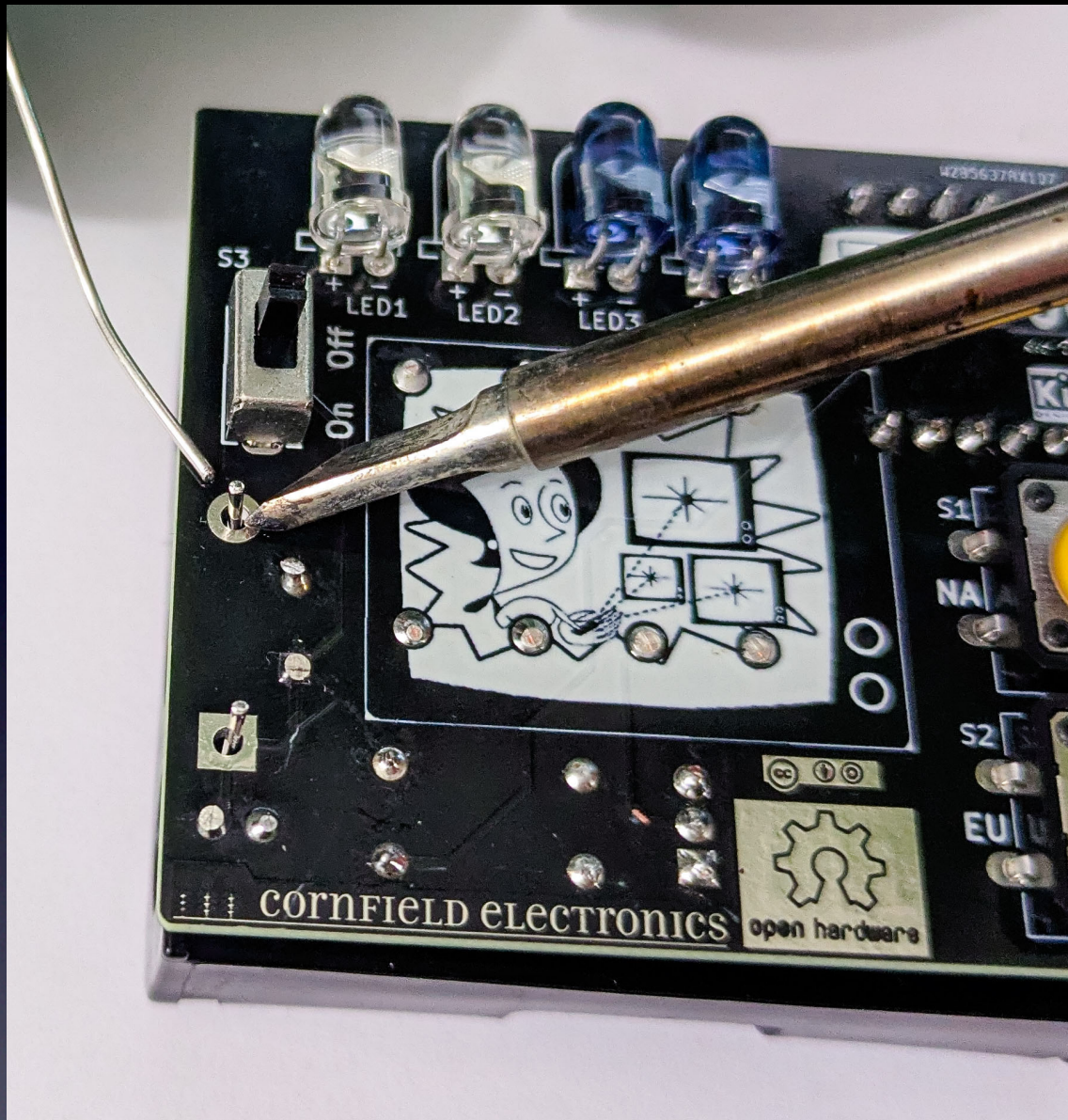

Solder both leads of the battery pack

DO NOT CUT THESE 2 LEADS!

(it will destroy the wire cutters)

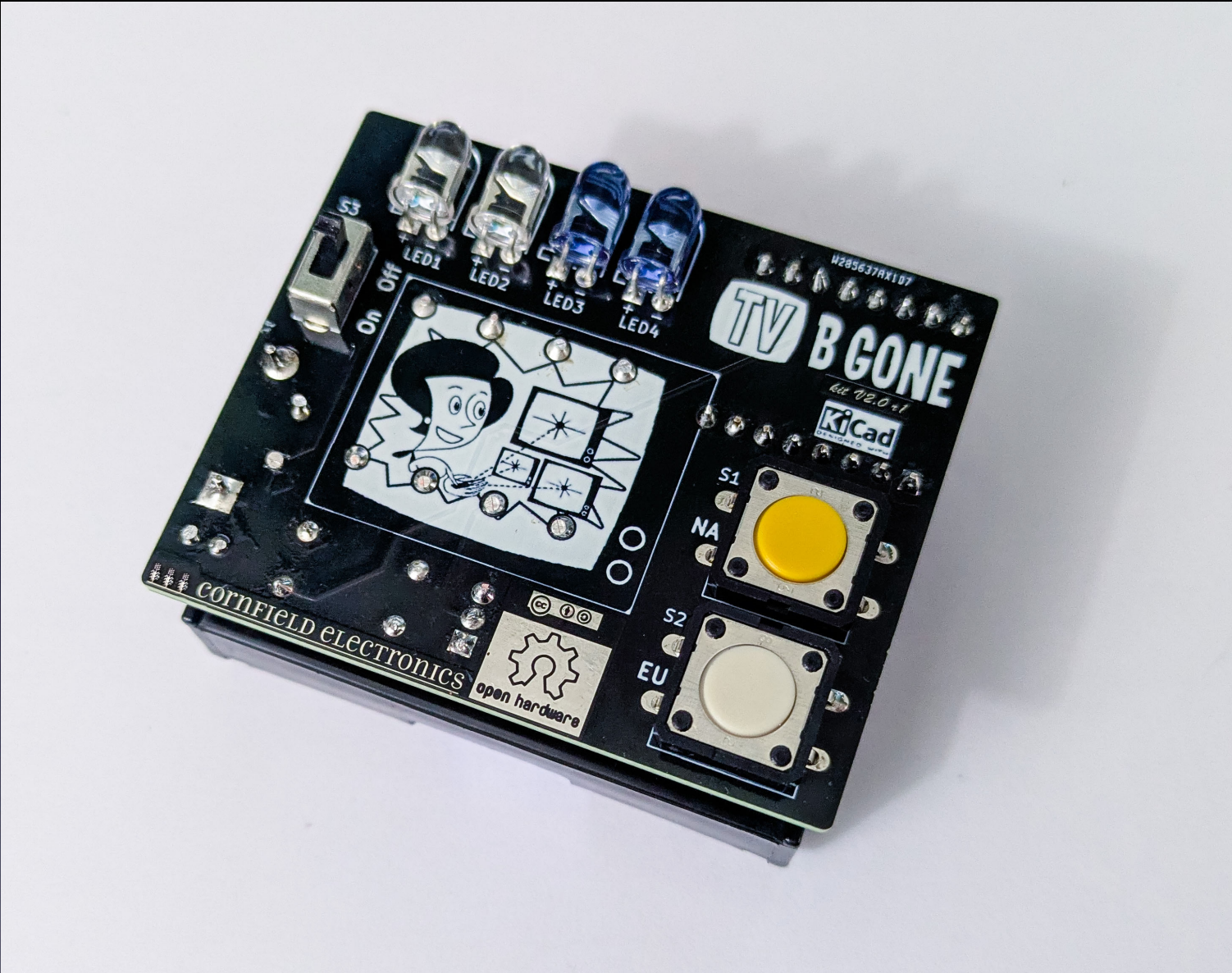

Done !

Please Remember:

to

Wash your hands

after soldering

TV B GONE®

Turn off TVs!!



Make the world a better place



Kit

V2 r2

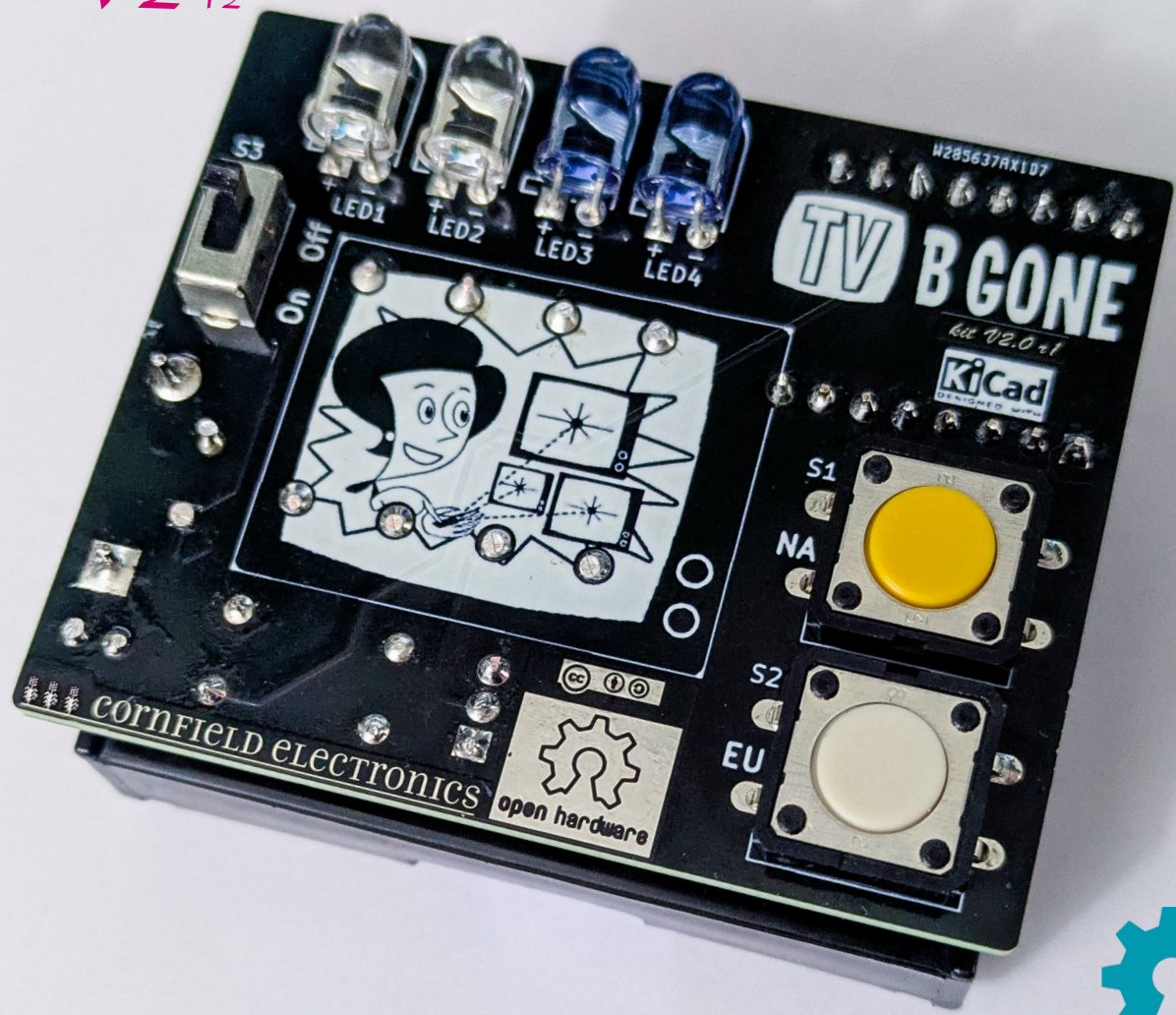

Turn off TVs in public places from 50 meters away!

