

# Arduino For Total Newbies

## *w/ TV-B-Gone as example project*

## Mitch Altman

Chief Scientist, **Cornfield Electronics**, San Francisco, CA

Inventor of **TV-B-Gone** universal remote controls

Co-founder of **3Ware** (successful Silicon Valley startup)

Pioneer of **VR** (in the mid-1980s)

Founding mentor at **HAX** (1<sup>st</sup> and biggest hardware accelerator)

Co-founder of **Noisebridge** (San Francisco hackerspace)

email: [mitch@CornfieldElectronics.com](mailto:mitch@CornfieldElectronics.com)

site: [www.CornfieldElectronics.com](http://www.CornfieldElectronics.com)

twitter: [@maltman23](https://twitter.com/maltman23)

flickr: [maltman23](https://www.flickr.com/photos/maltman23/)

WeChat: [mitchaltman](#)



CORNFIELD ELECTRONICS

*useful electronics for a better world*

# Syllabus

- Intro
- Everything You Need to Know About Electronics
- *[How to solder / make your own Arduino] ← not in today's workshop*
- How to Set Up and Use the Arduino Software
- How to Hack Arduino Programs (“Sketches”)
- How to Use Solderless Breadboards
- How to Read a Schematic
- Make a TV-B-Gone Remote Control with your Arduino Clone without soldering

# Intro

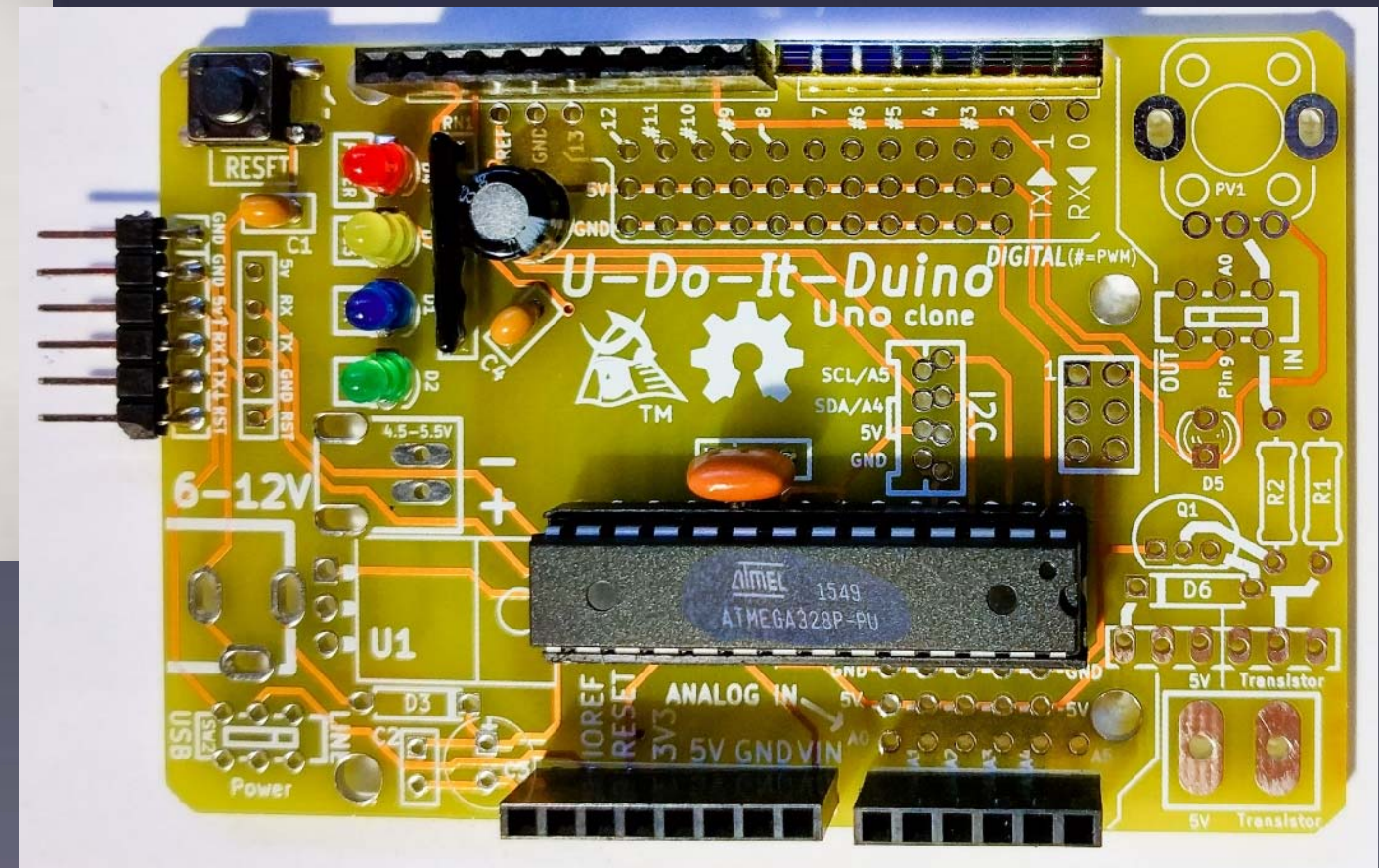
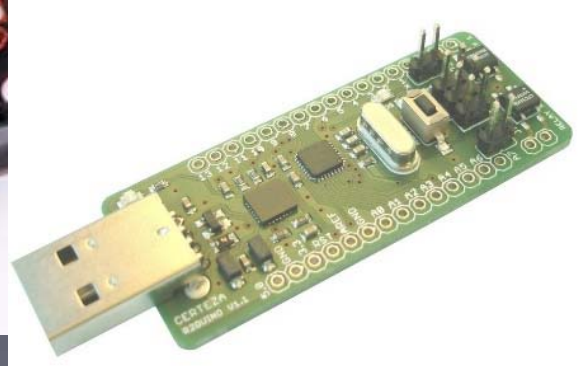
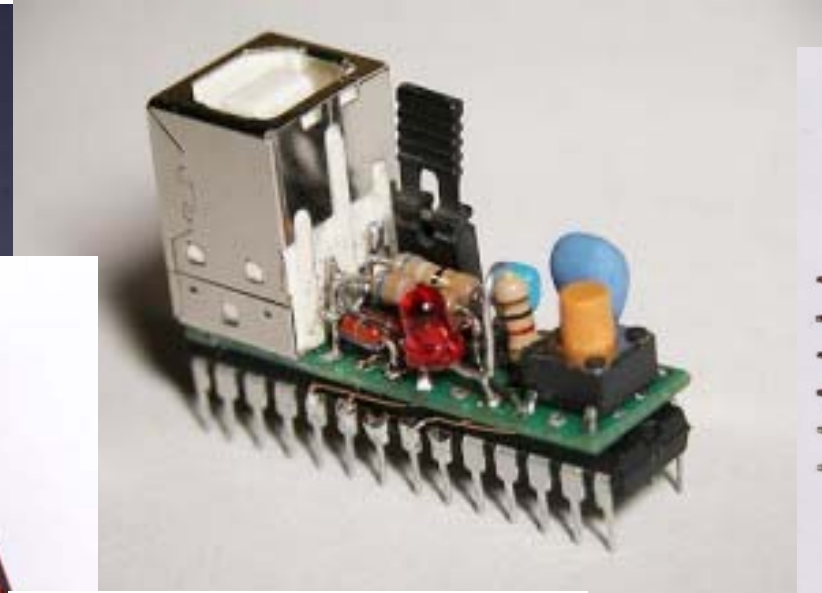
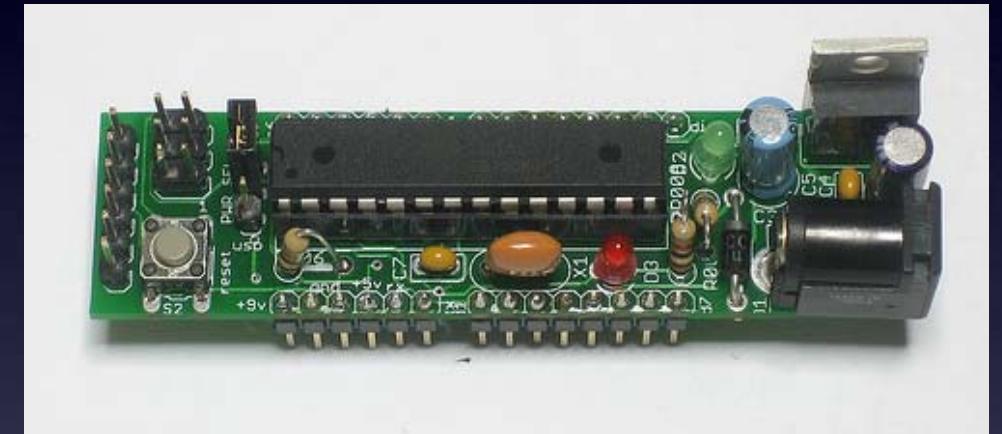
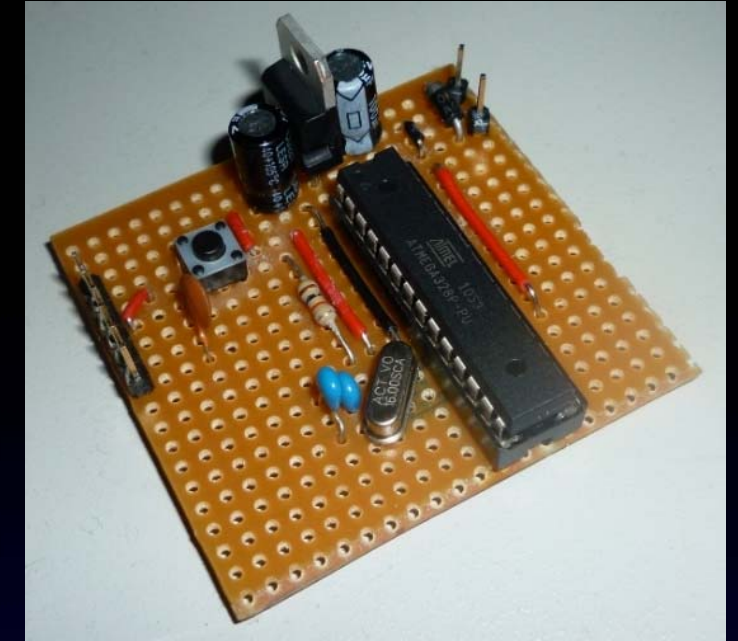
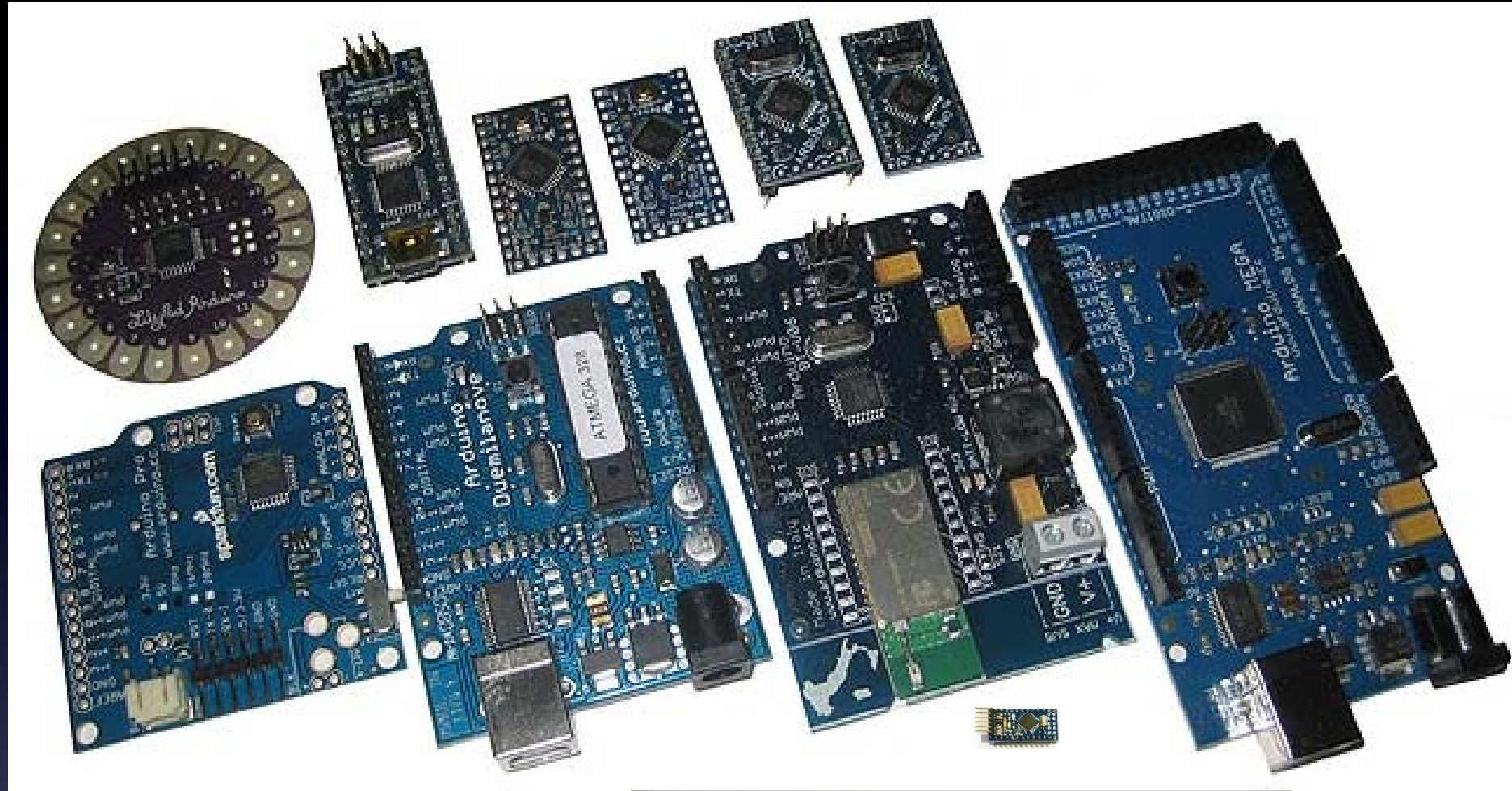

# *Everything You Need to Know About Electronics*

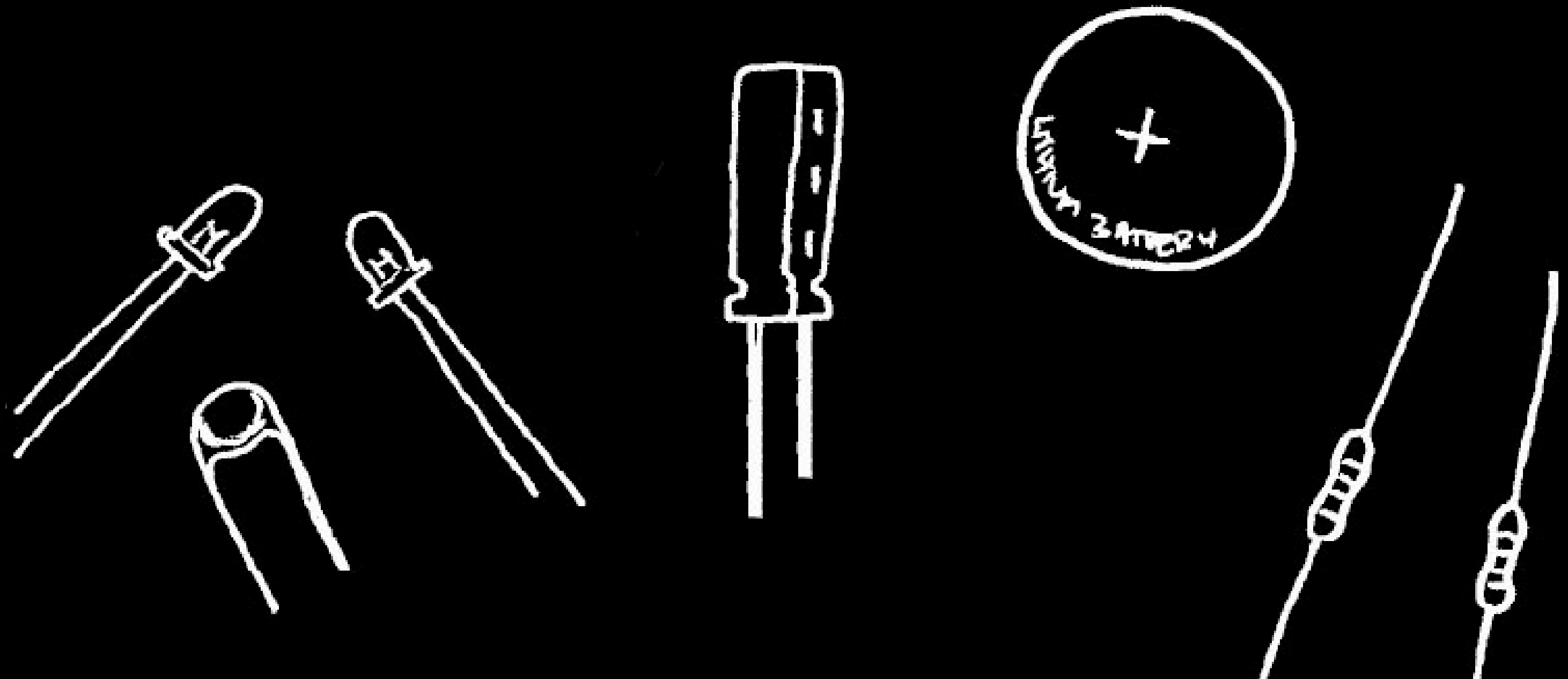

# Learn To Solder



download for free at:  
<http://mightyohm.com/soldercomic>

# Learn To Solder

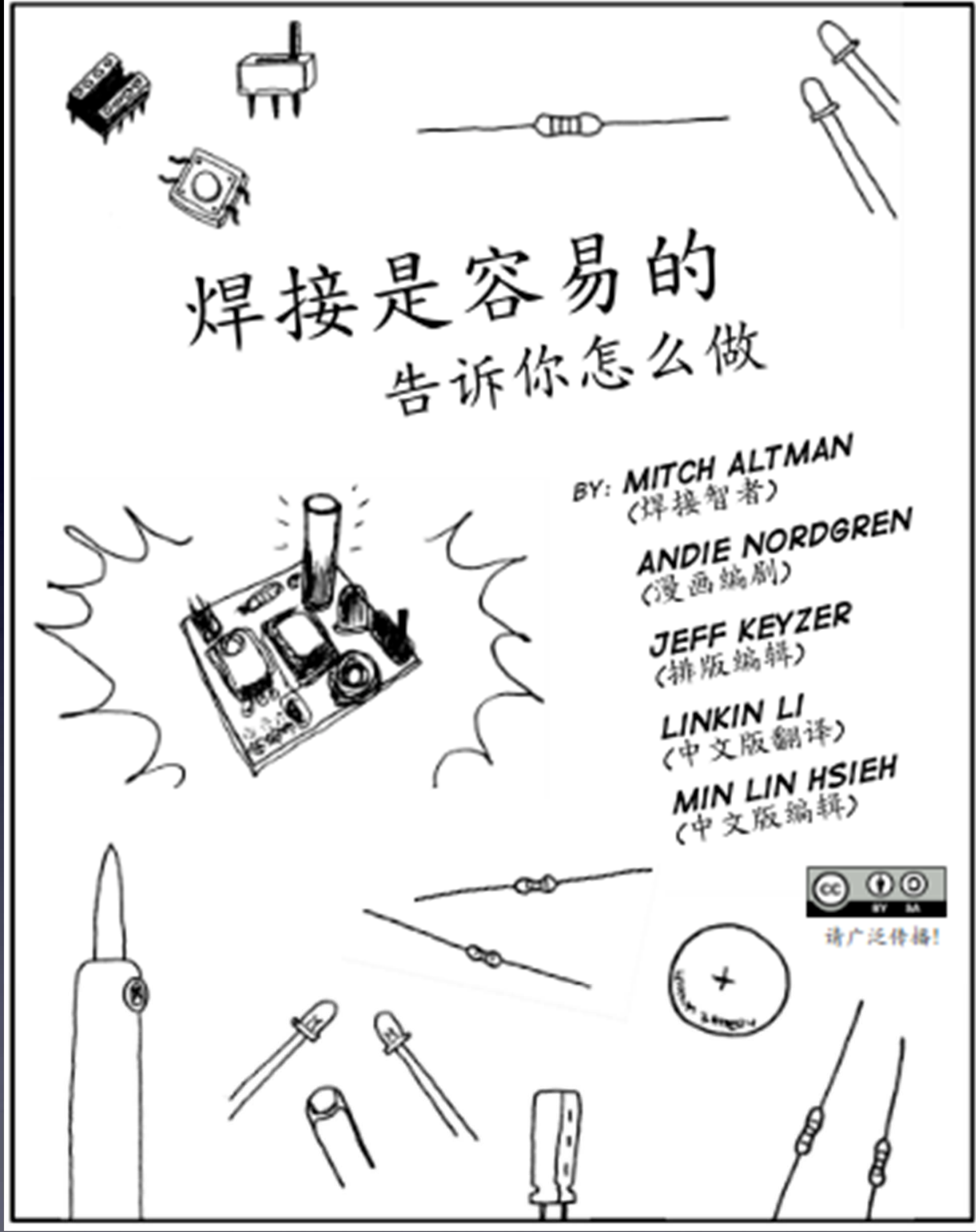

Download in the language of your choice for free at:

<http://mightyohm.com/soldercomic>

# Learn To Solder

## ***SOLDER C'EST FACILE*** ***VOICI COMMENT FAIRE***

DE: ***MITCH ALTMAN***  
(MAITRE SOUDEUR)

***ANDIE NORDGREN***  
(ADAPTATION BD)

***JEFF KEYZER***  
(EDITION, MISE EN PAGE)

***SNOOTLAB***  
(TRADUCTION FR.)

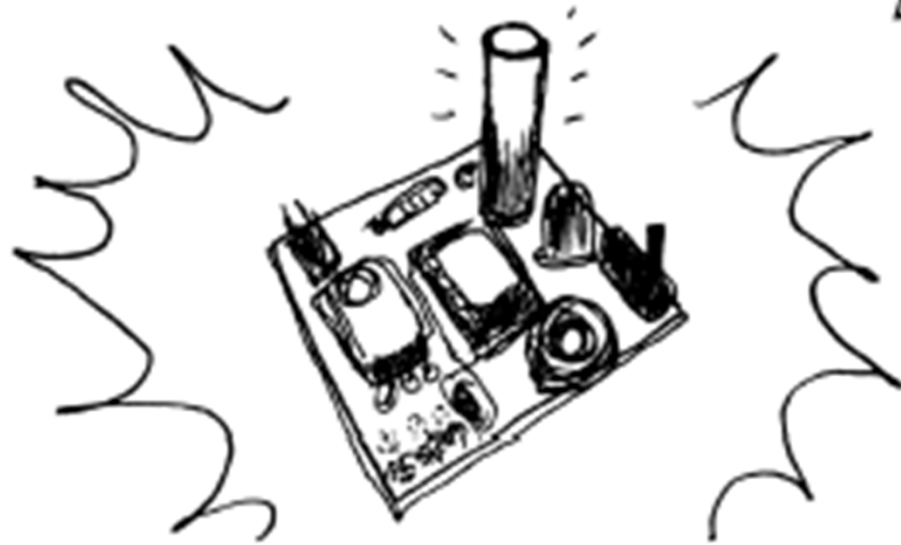

TELECHARGEZ CETTE BD  
ET PARTAGEZ LA AVEC VOS AMIS !  
[HTTP://MIGHTYOHM.COM/SOLDERCOMIC](http://mightyohm.com/soldercomic)



A DIFFUSER LARGEMENT !

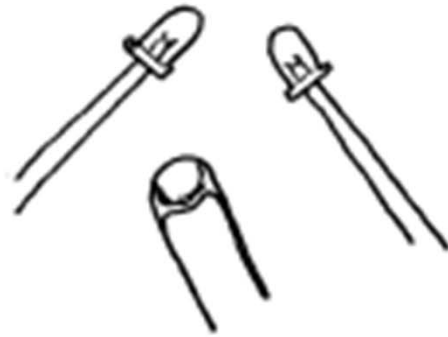
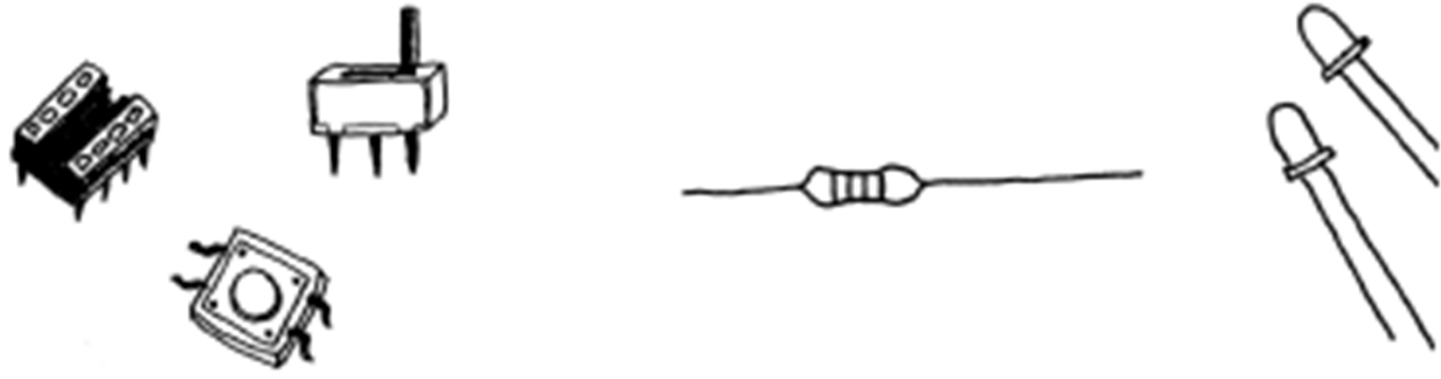

Download in the language of your choice for free at:  
<http://mightyohm.com/soldercomic>

# Learn To Solder

## **SOLDAR ES FÁCIL!** *APRENDE CÓMO HACERLO*

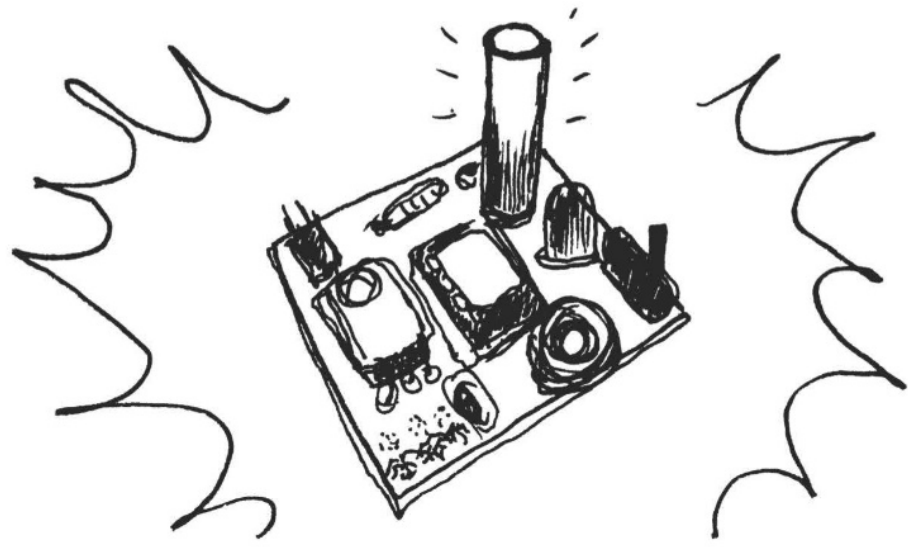

**POR: MITCH ALTMAN**  
(SABIDURÍA EN SOLDADO)

**ANDIE NORDGREN**  
(ADAPTACIÓN A COMIC)

**JEFF KEYZER**  
(DISEÑO Y EDICIÓN)



*DISTRIBUYE AMPLIAMENTE!*

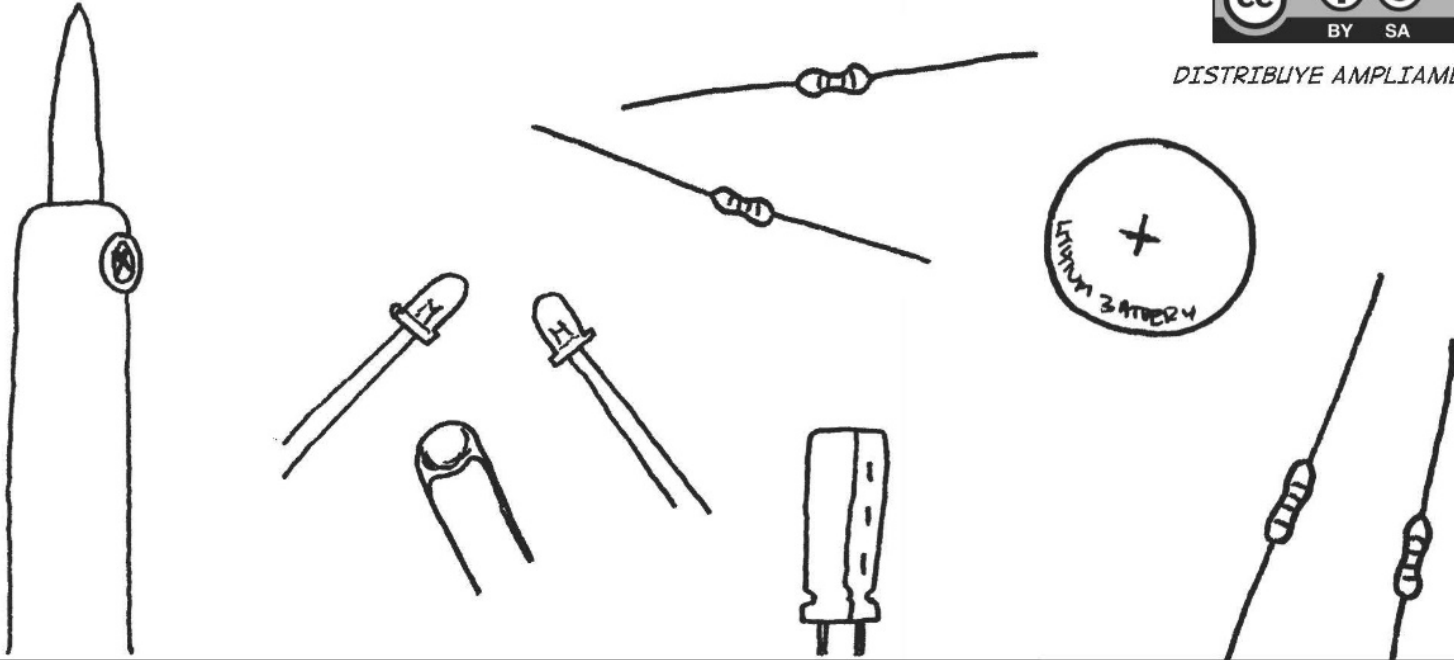
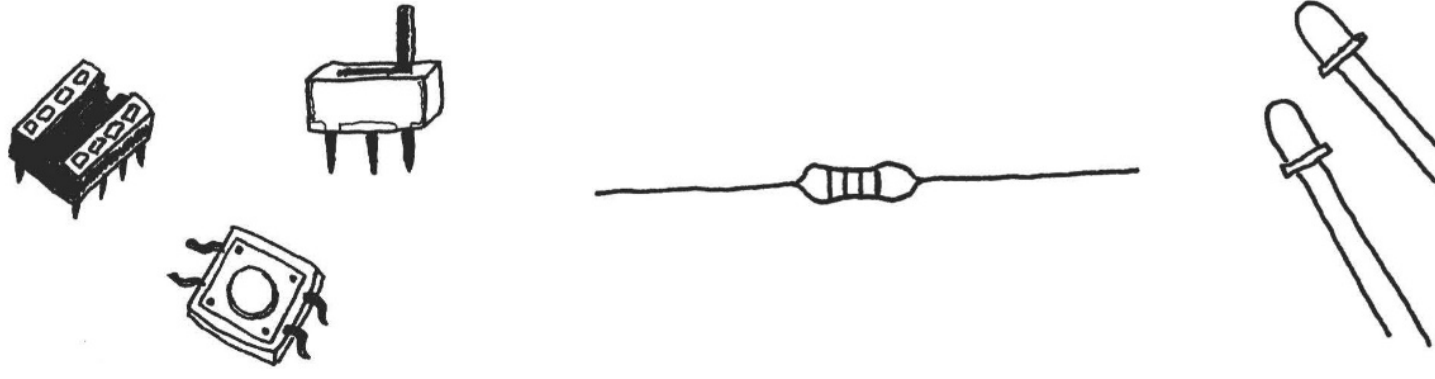

Download in the language of your choice for free at:  
<http://mightyohm.com/soldercomic>



# Learn To Solder



Download in the language of your choice for free at:

<http://mightyohm.com/soldercomic>

# Solder Your Arduino Clone

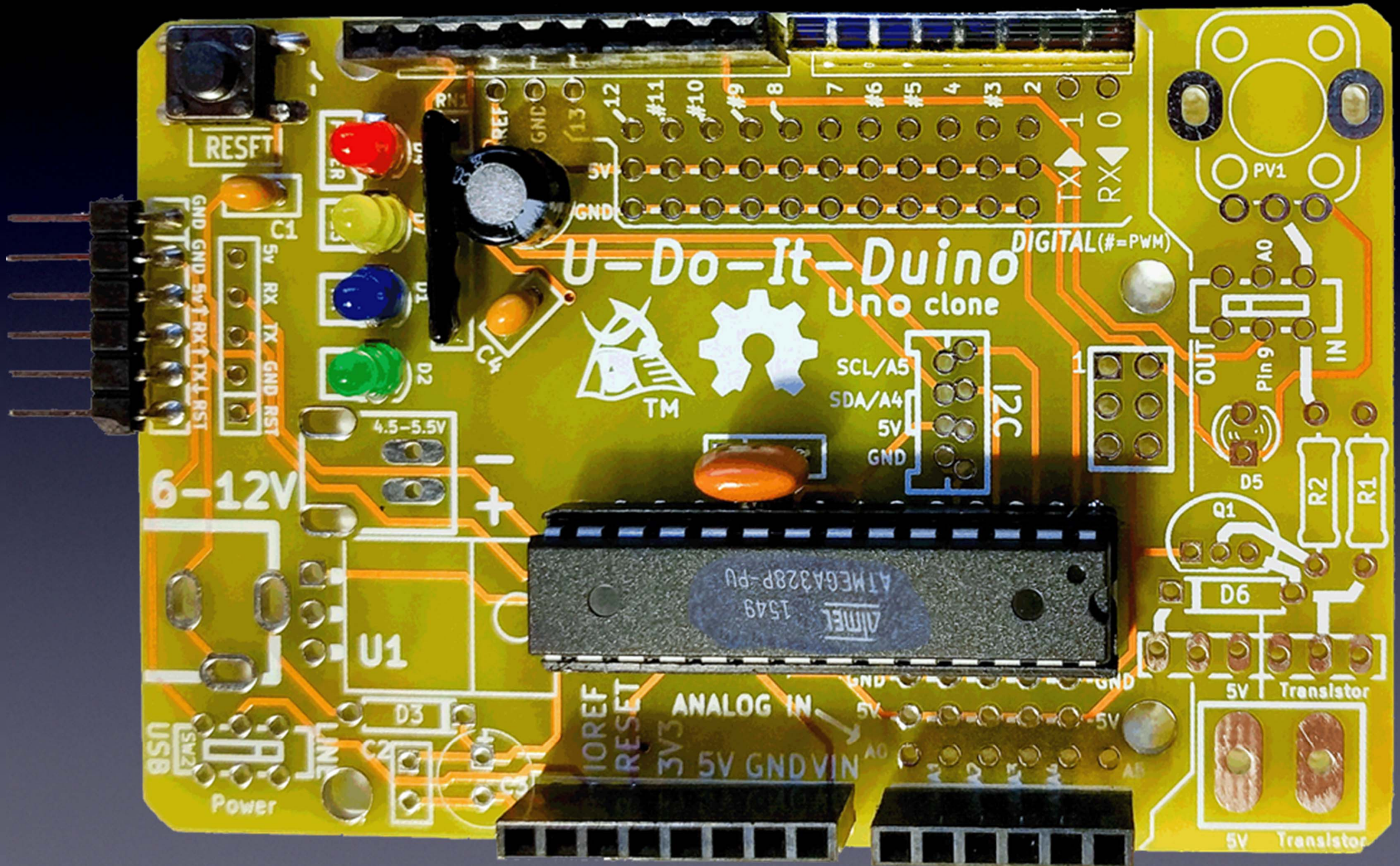

# How to Set Up and Use the Arduino Software

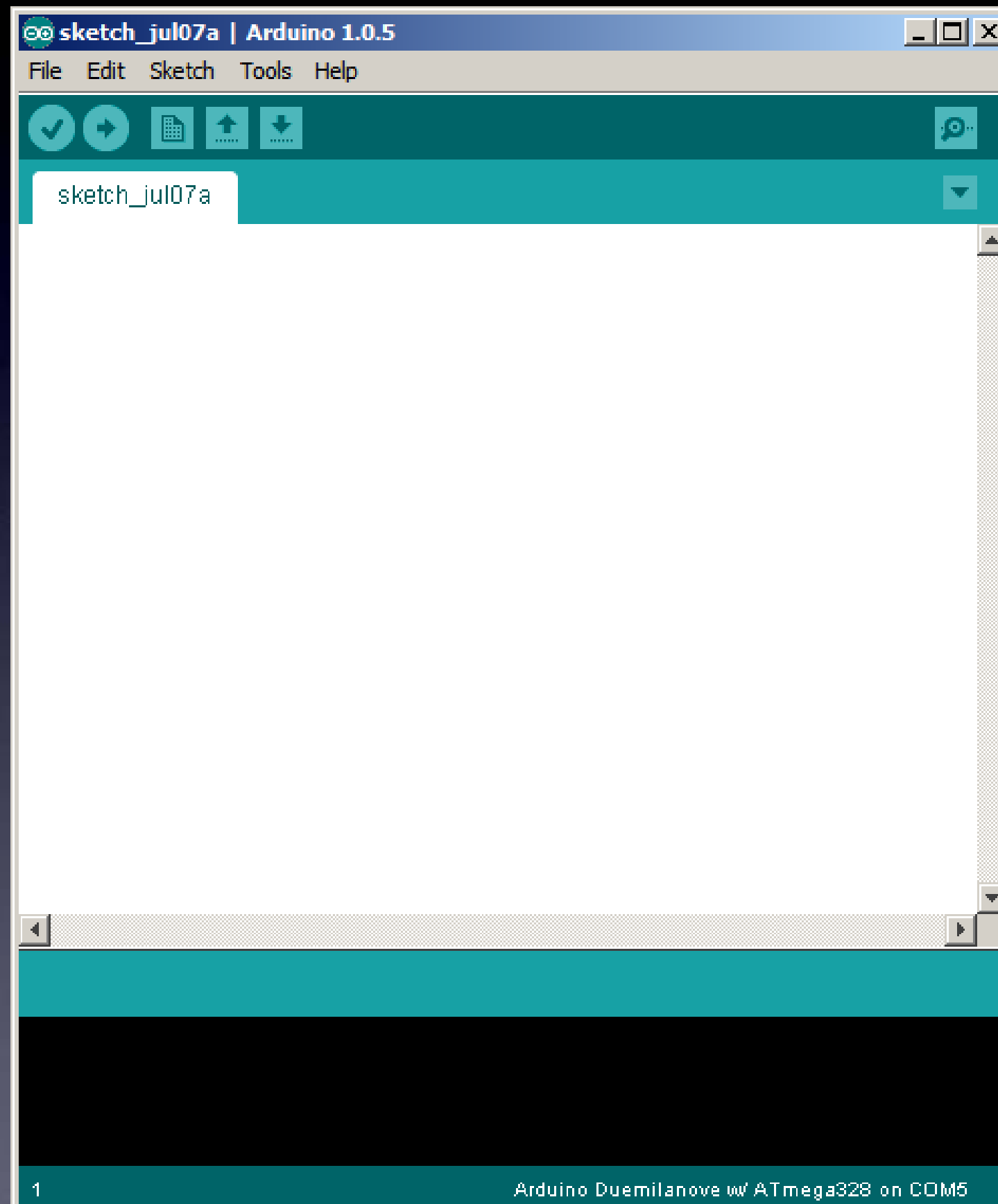

# How to Hack Arduino Programs (“Sketches”)

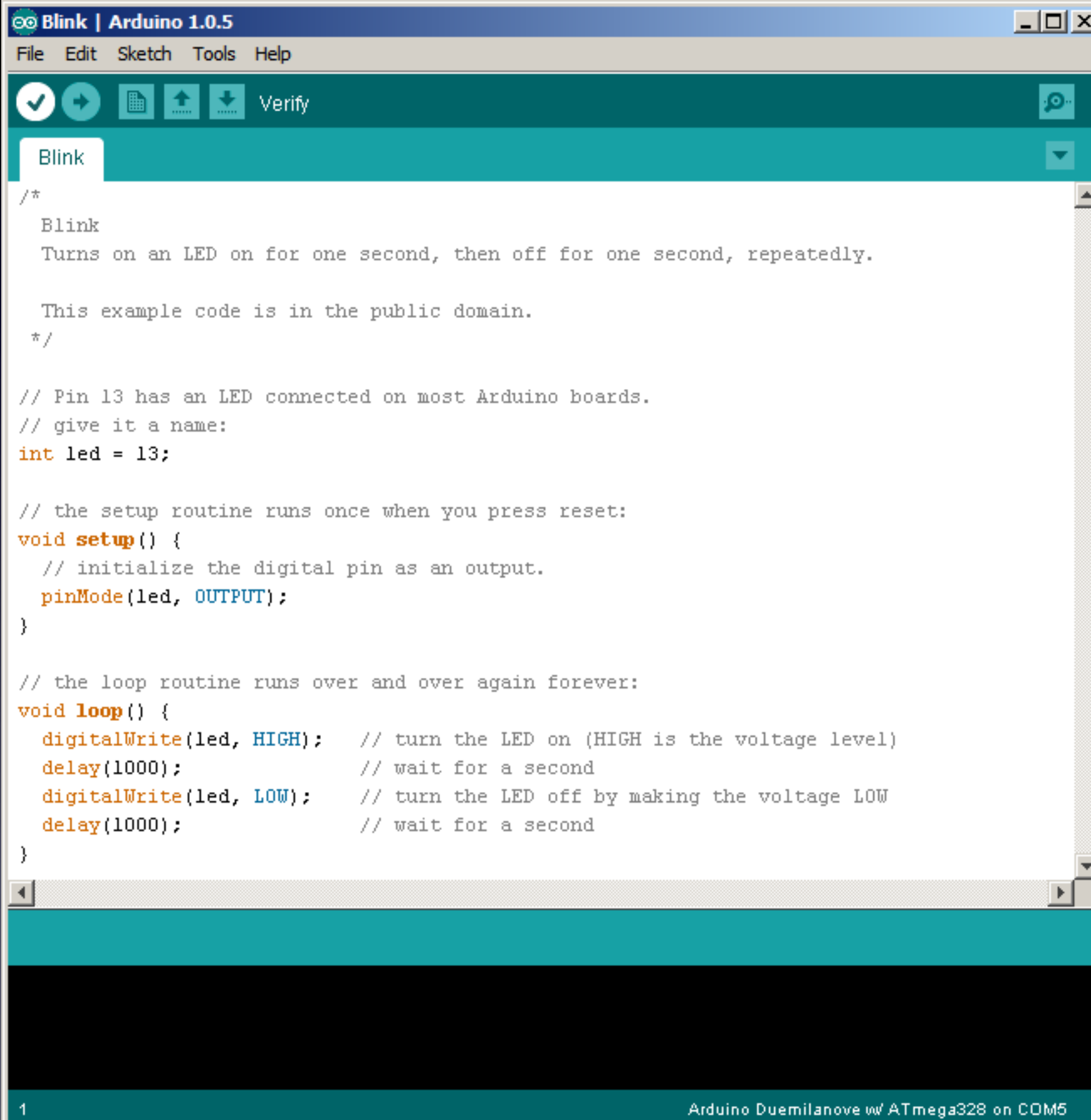

The image shows a screenshot of the Arduino IDE interface. The title bar reads "Blink | Arduino 1.0.5". The menu bar includes "File", "Edit", "Sketch", "Tools", and "Help". Below the menu bar is a toolbar with icons for a checkmark, a play button, a document, an upload arrow, a download arrow, and a "Verify" button. A tab labeled "Blink" is active. The main text area contains the following code:

```
/*
  Blink
  Turns on an LED on for one second, then off for one second, repeatedly.

  This example code is in the public domain.
  */

// Pin 13 has an LED connected on most Arduino boards.
// give it a name:
int led = 13;

// the setup routine runs once when you press reset:
void setup() {
  // initialize the digital pin as an output.
  pinMode(led, OUTPUT);
}

// the loop routine runs over and over again forever:
void loop() {
  digitalWrite(led, HIGH); // turn the LED on (HIGH is the voltage level)
  delay(1000);             // wait for a second
  digitalWrite(led, LOW);  // turn the LED off by making the voltage LOW
  delay(1000);             // wait for a second
}
```

At the bottom of the window, the status bar shows "1" on the left and "Arduino Duemilanove w/ ATmega328 on COM5" on the right.

# How to Use Solderless Breadboards

## Solderless Breadboard

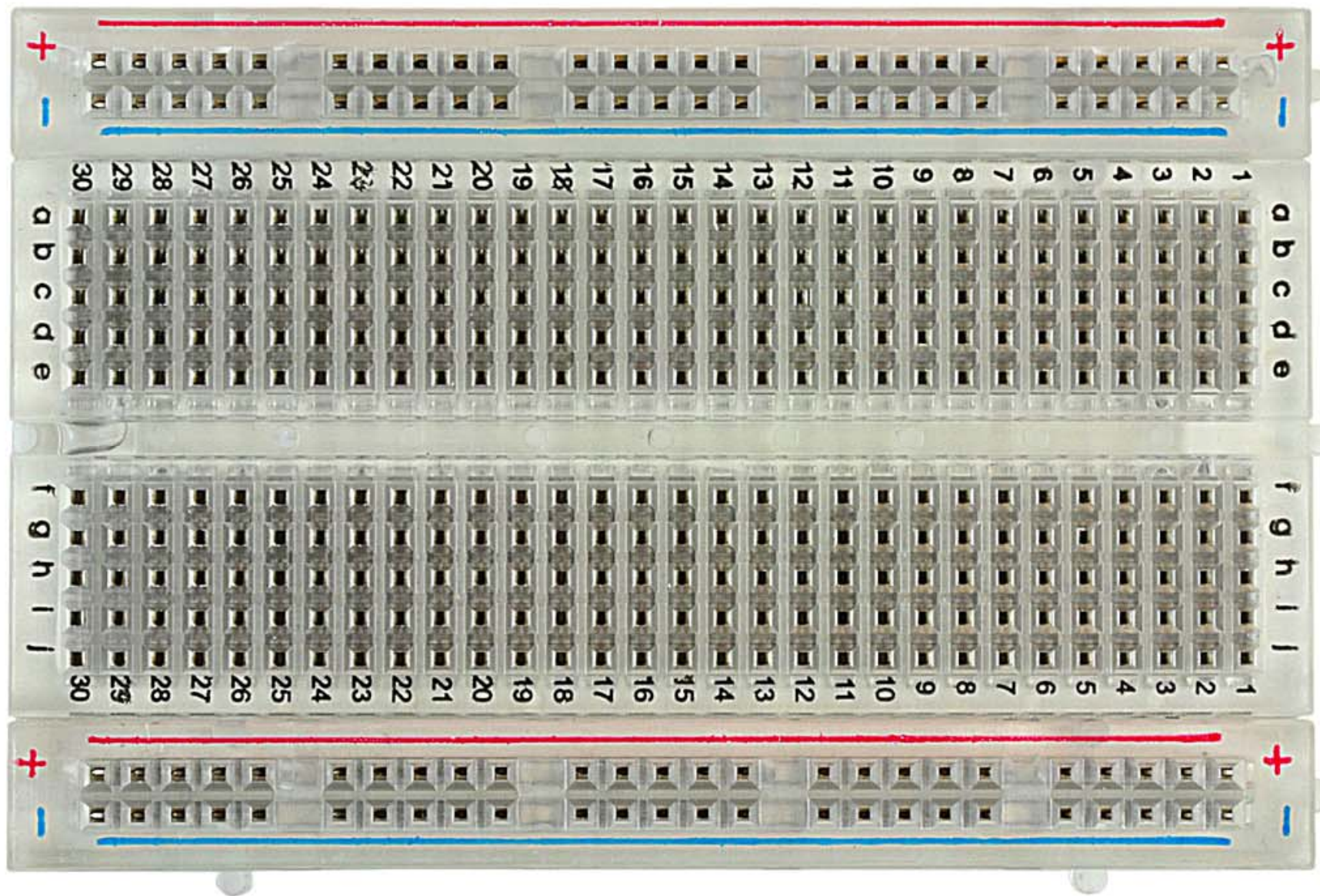

# How to Use Solderless Breadboards

## Solderless Breadboard with LED and wires

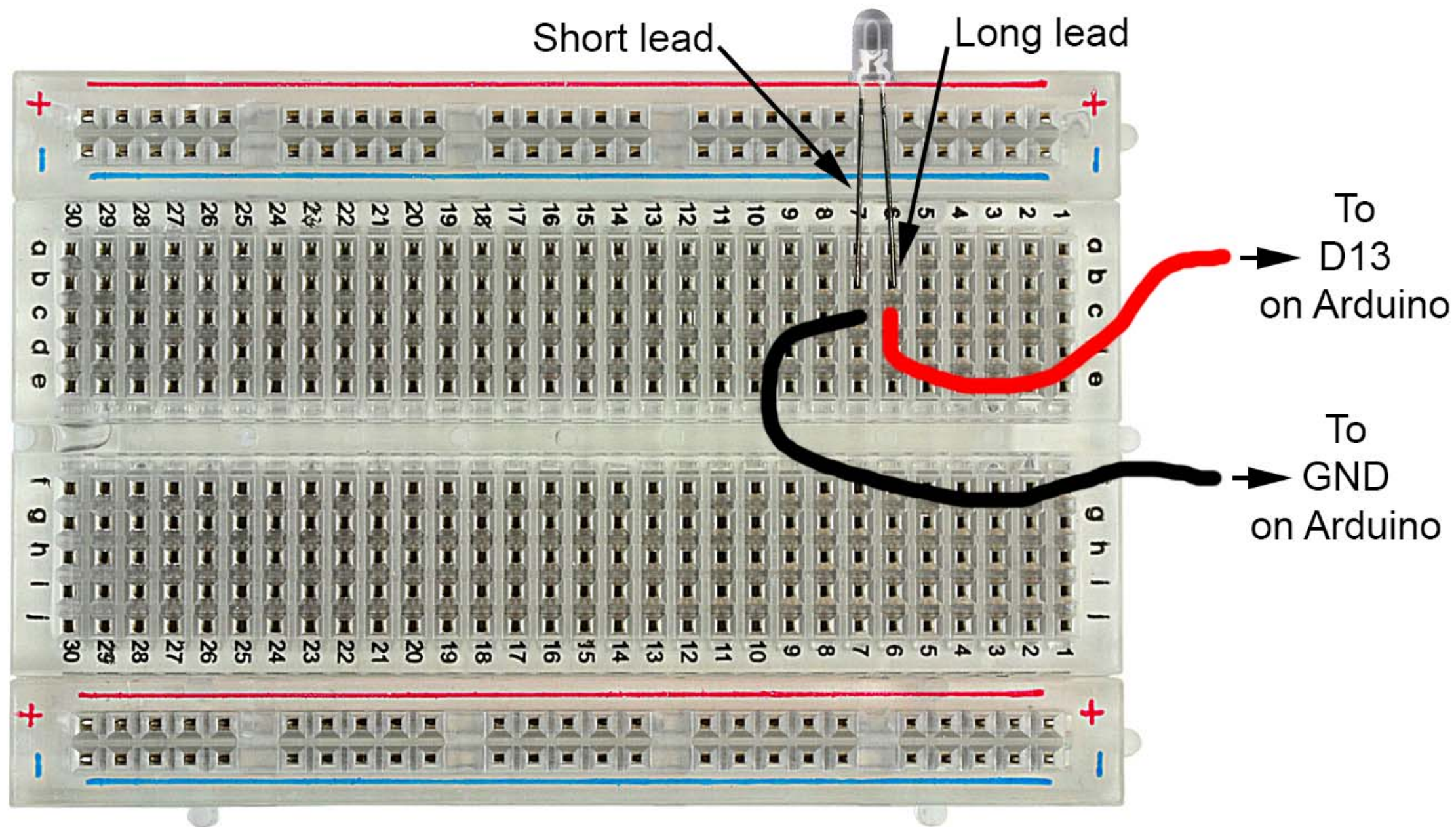

## Arduino For Total Newbies

4-Sep-2015

Mitch Altman (original TV-B-Gone hardware and firmware, modified TV-B-Gone Arduino design)  
Limore Fried (firmware modifications, kit design)  
Ken Shirriff (original modifications for Arduino)  
Johannes Schneemann (documentation)

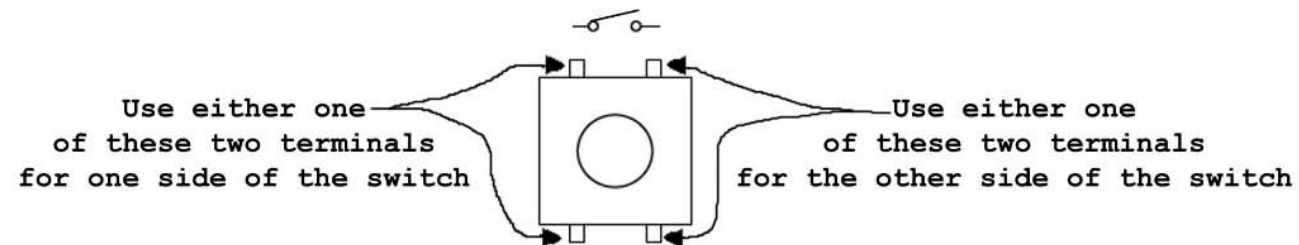
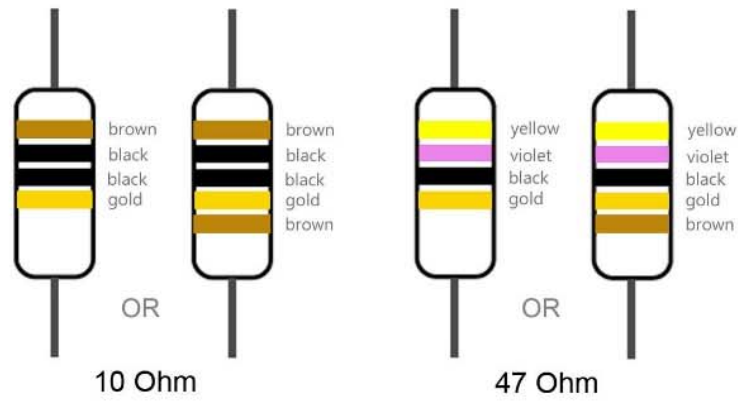
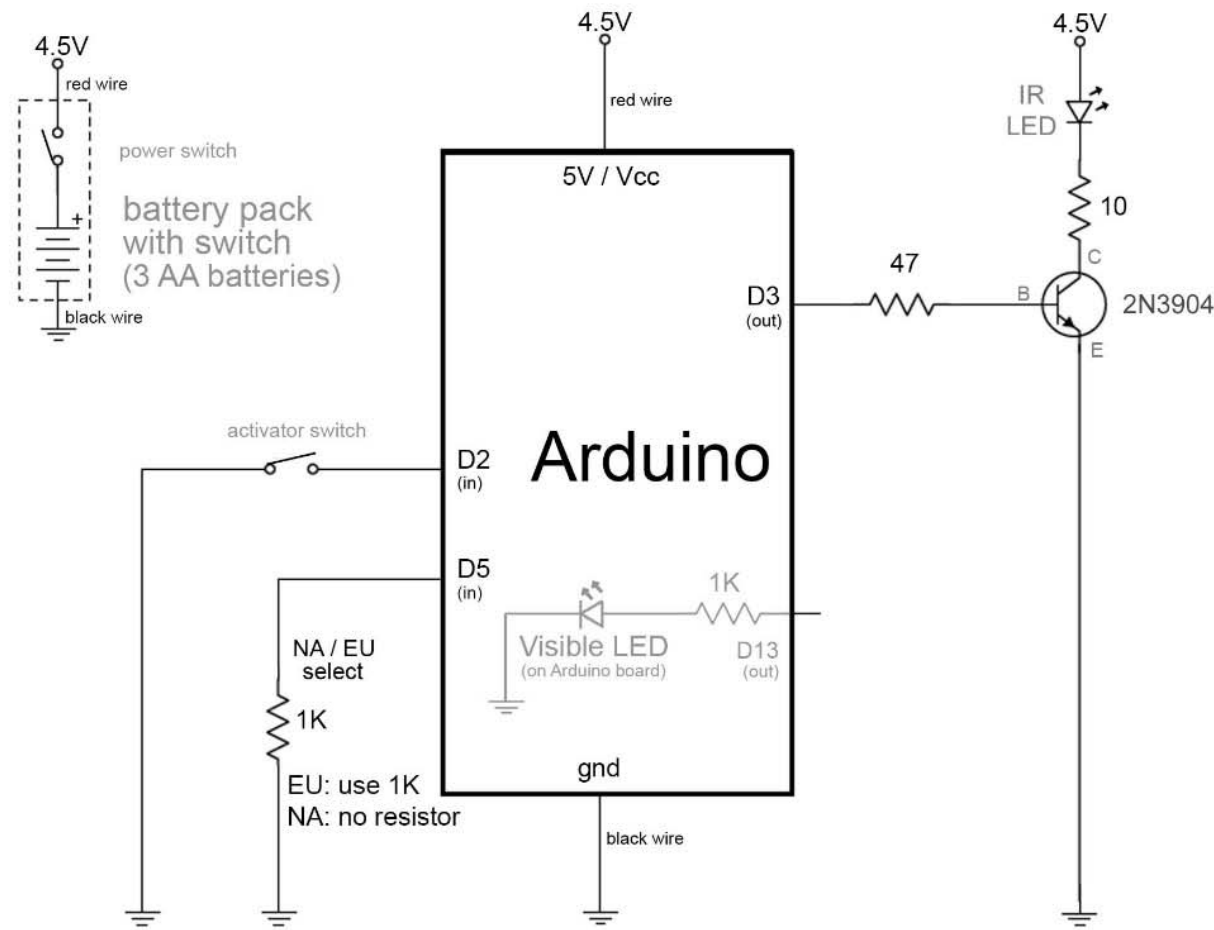

# Make a TV-B-Gone Remote Control with your Arduino Clone without soldering

## Solderless Breadboard with parts & wires for TV-B-Gone

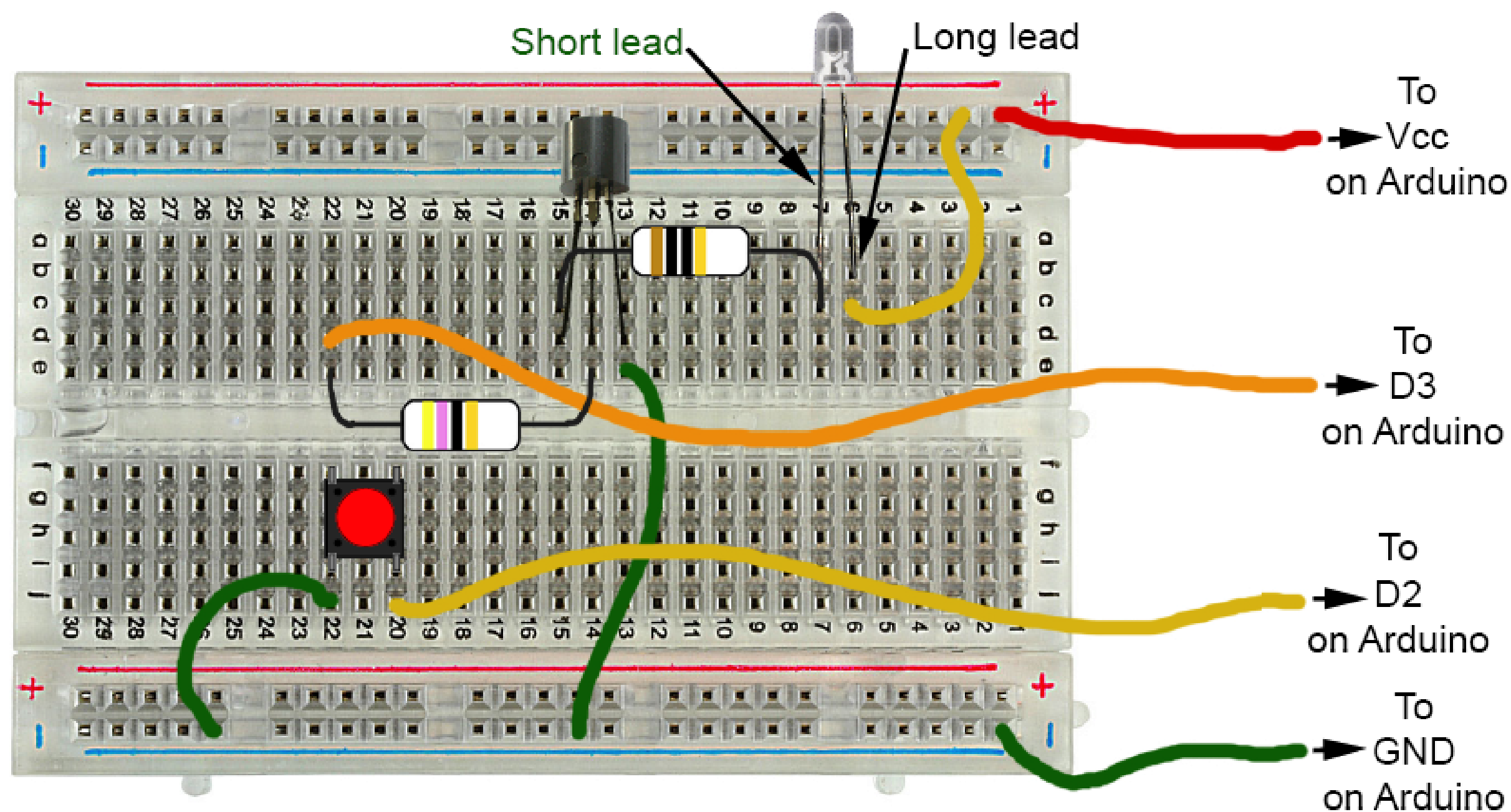



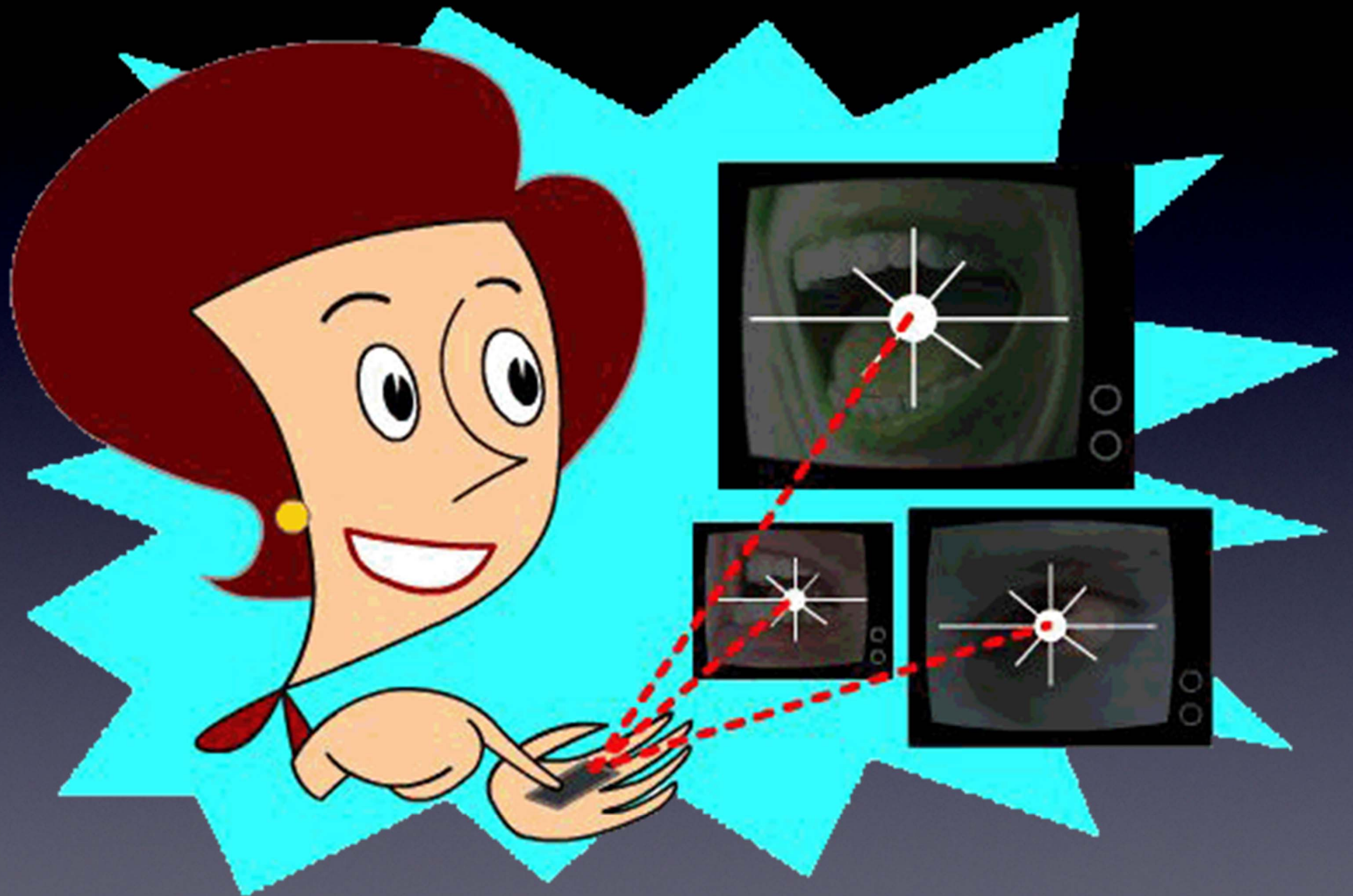

Questions?

# Intro



# Intro

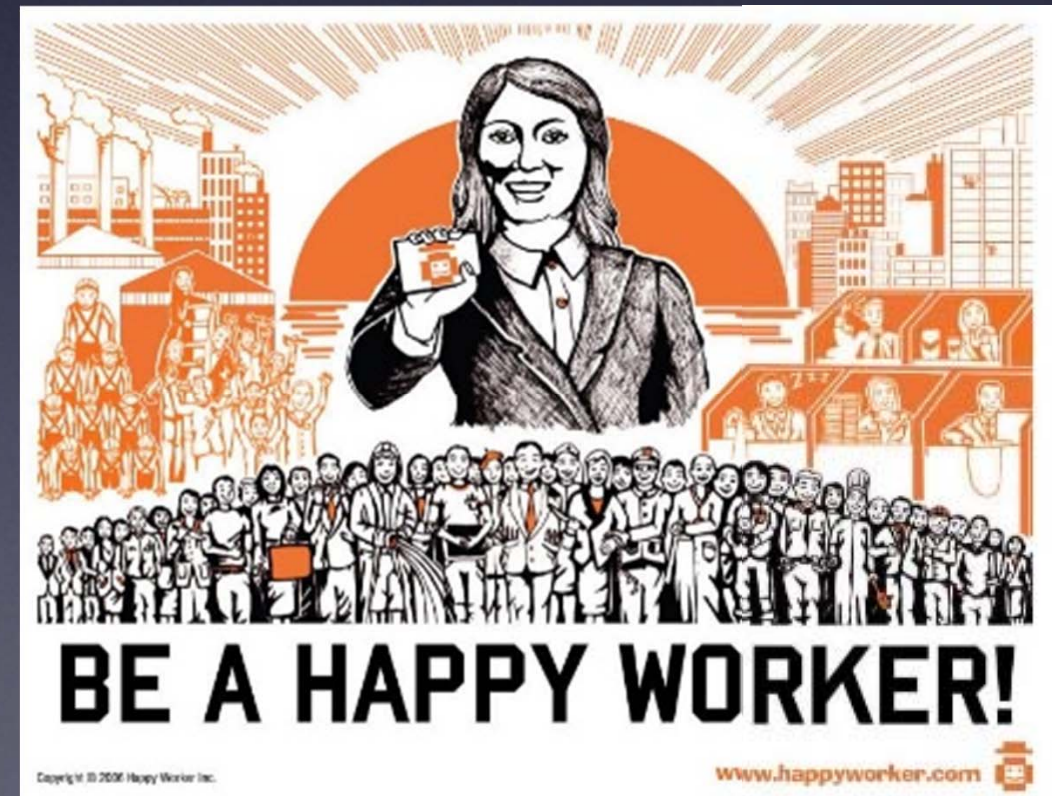

# Intro

*Cornfield*  
 *Electronics, Inc.*

---

**MITCH ALTMAN**

Chief Scientist / CEO

*“Useful Electronics for a Better World”*



**[www.CornfieldElectronics.com](http://www.CornfieldElectronics.com)**

572 Hill St. #Penthouse, San Francisco, CA 94114

phone: +1 415 / 377 - 5993

[mitch@CornfieldElectronics.com](mailto:mitch@CornfieldElectronics.com)

**@maltman23**

# Intro



Arduino For Total Newbies Workshop at 30C3, Hamburg Germany

# Intro to Arduino: microcontrollers

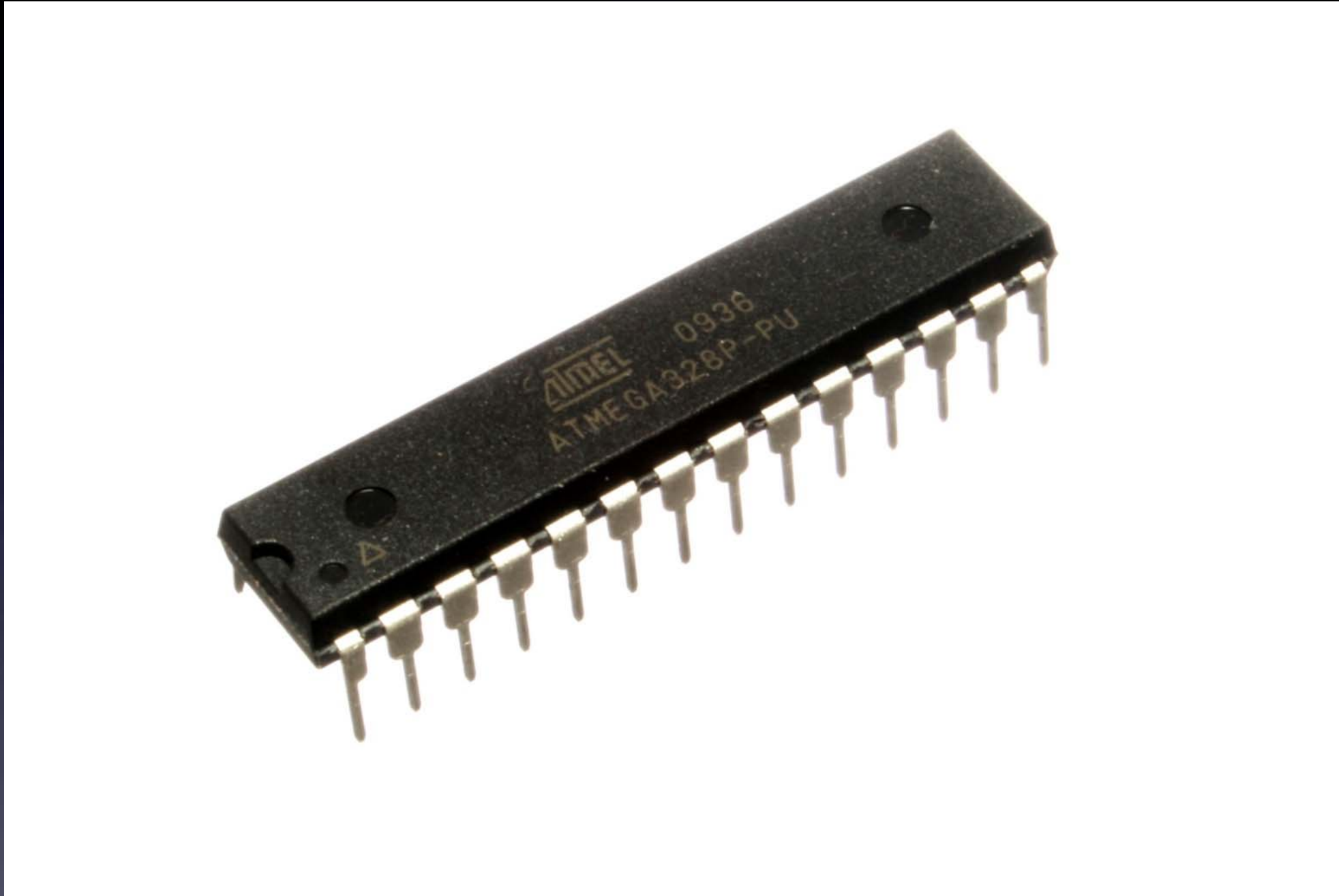

A complete computer on a chip

# Intro to Arduino: microcontrollers

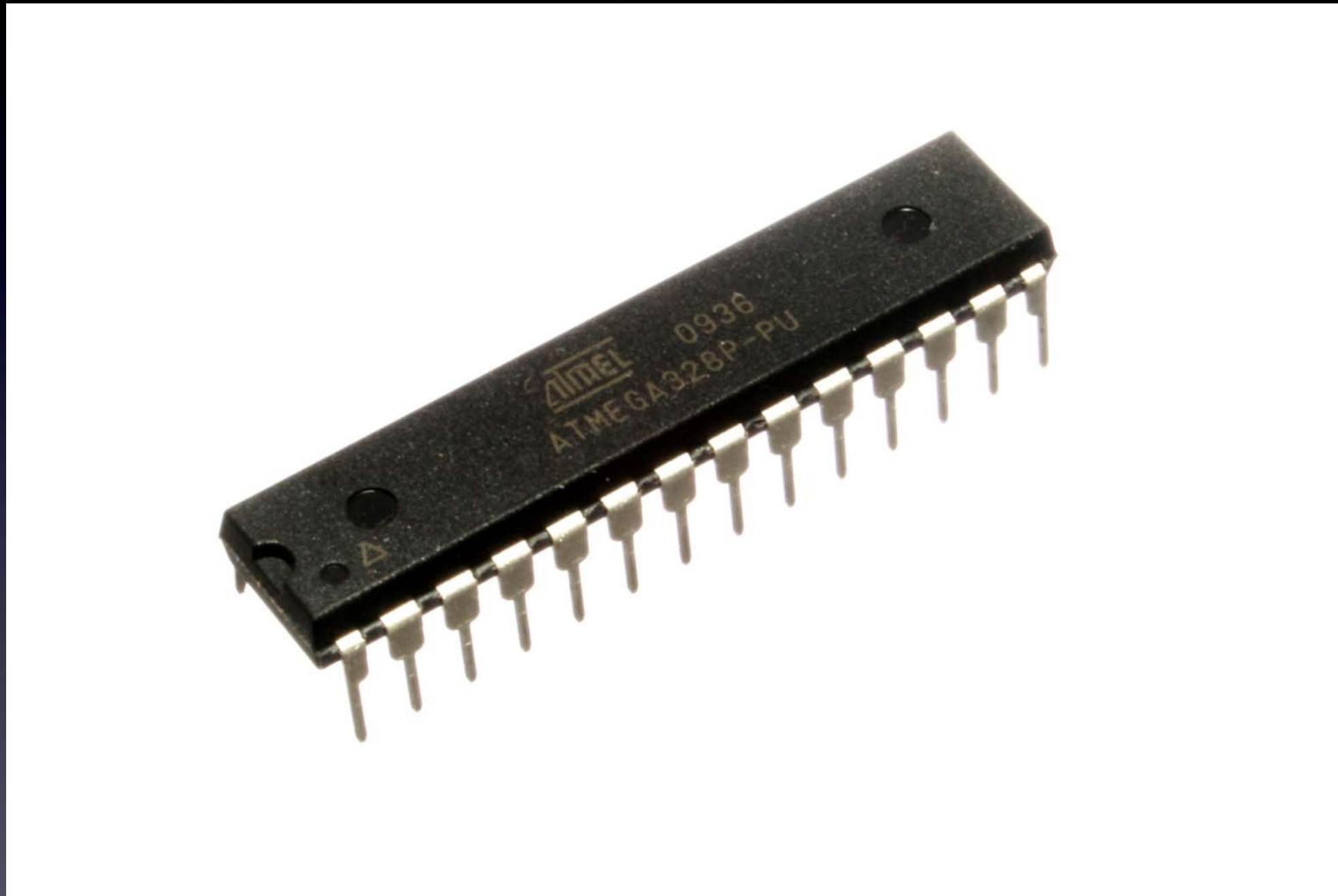

**A complete computer on a chip:**  
they control parts connected to their pins



# Intro to Arduino: microcontrollers

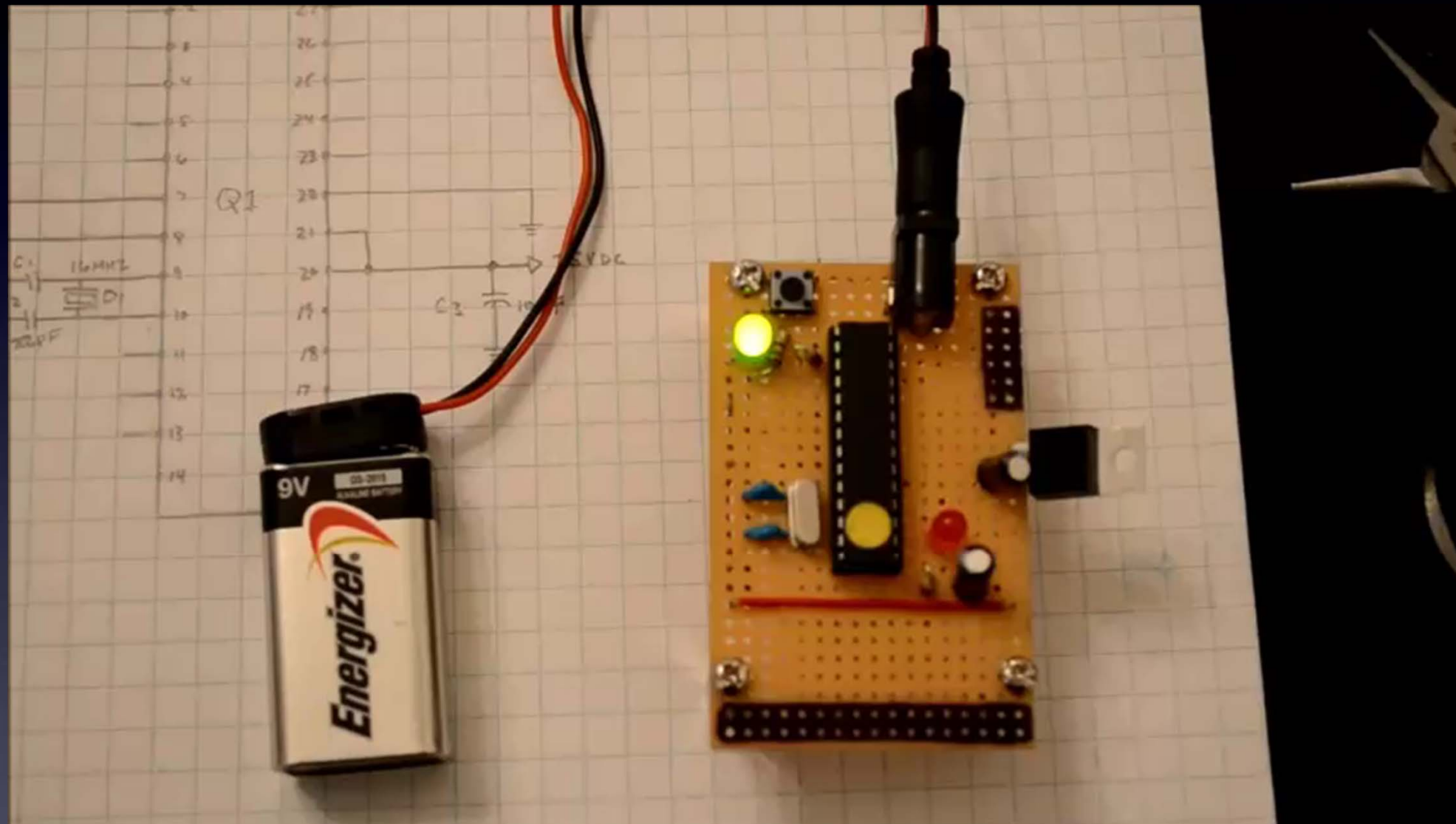

# Intro to Arduino: microcontrollers

*-- some of Mitch's projects --*

*Trippy RGB Waves kit*

# Intro to Arduino: microcontrollers

*-- some of Mitch's projects --*

*ArduTouch  
music  
synthesizer  
kit*

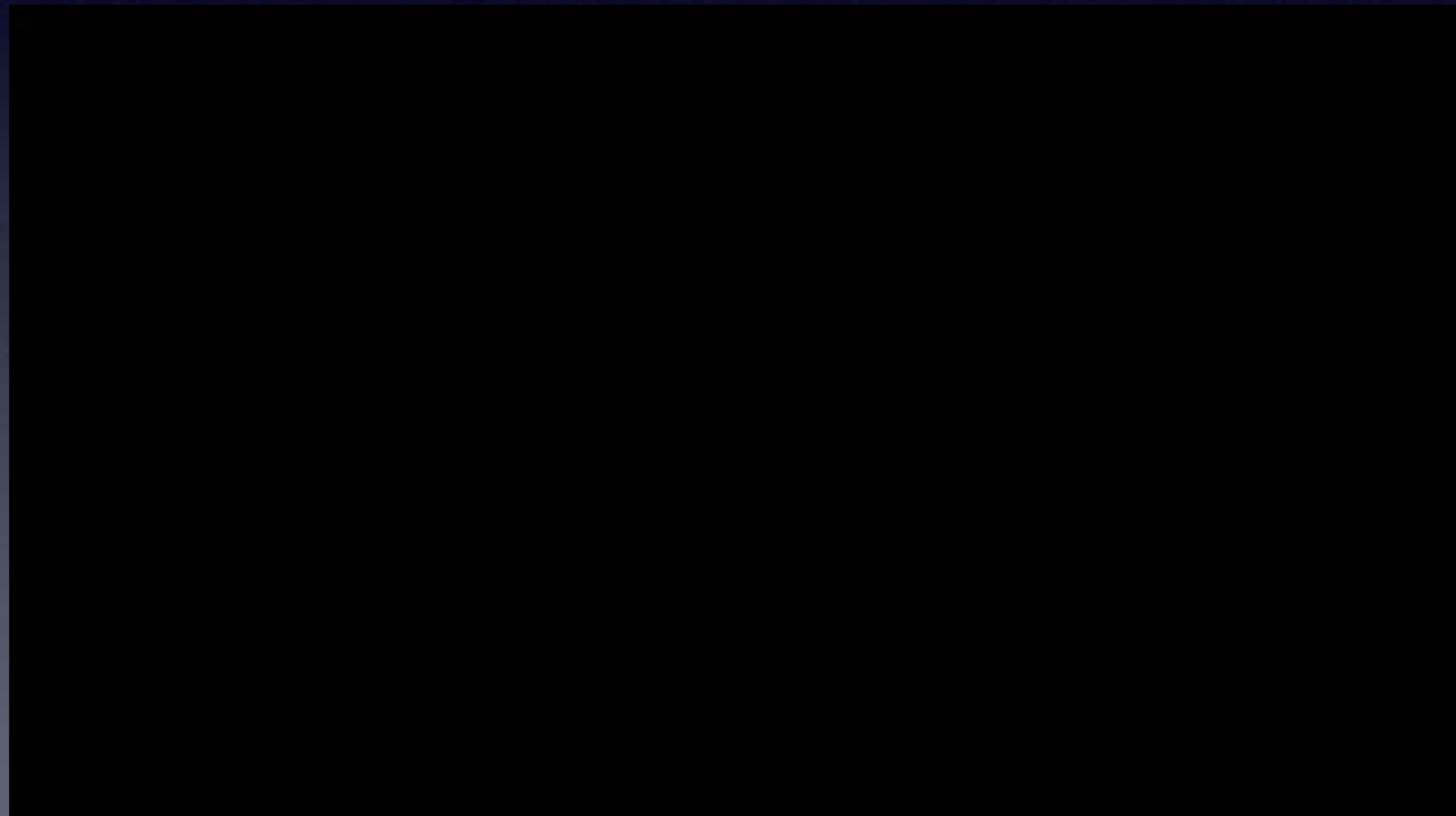

# Intro to Arduino: microcontrollers



# Intro to Arduino: microcontrollers

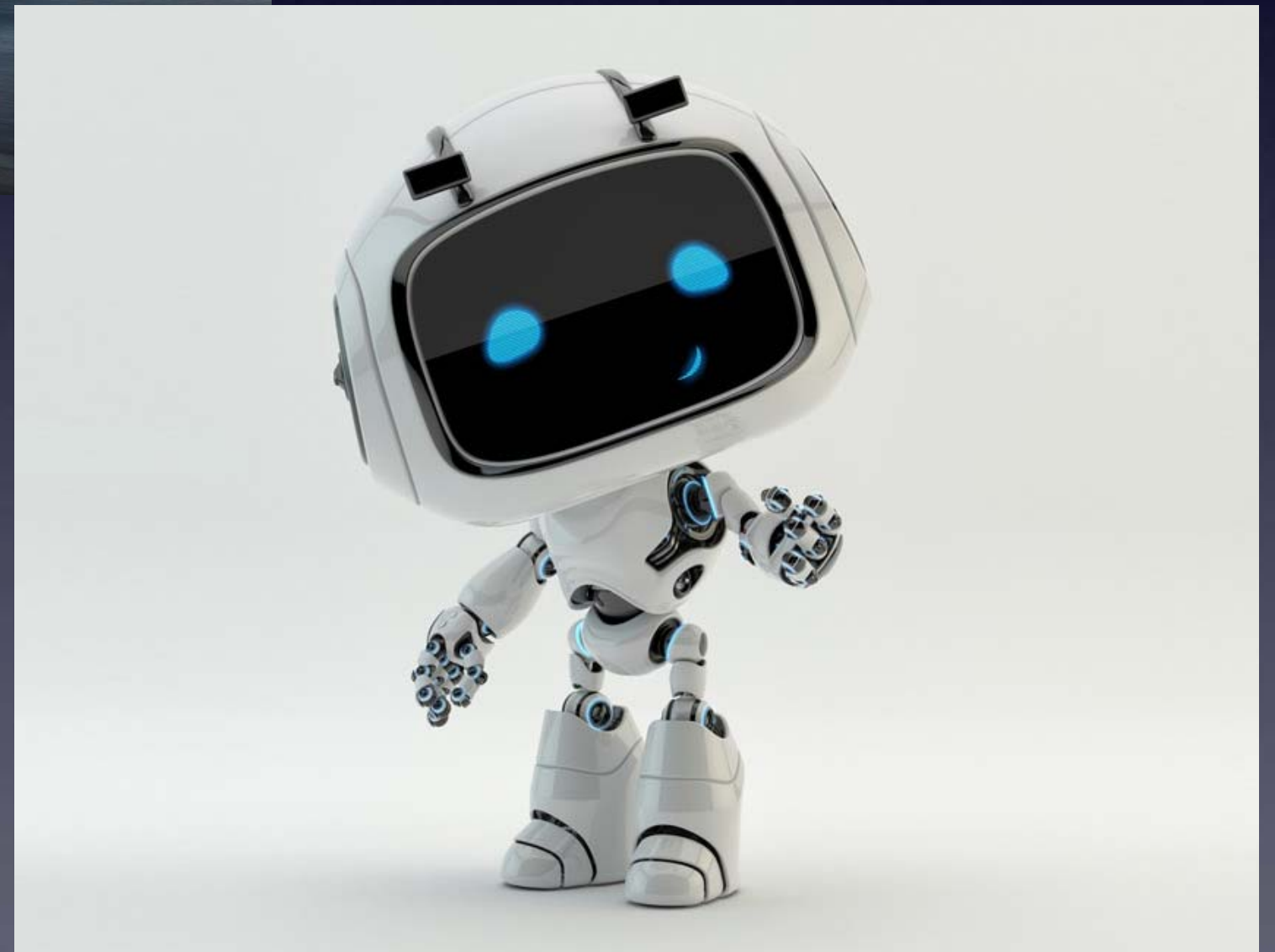

# Intro to Arduino: microcontrollers



# Intro to Arduino: microcontrollers



# Intro to Arduino: microcontrollers

*-- some of Mitch's projects --*

*TV-B-Gone*





# Intro to Arduino: microcontrollers

*-- some of Mitch's projects --*



## *TV-B-Gone*

*Just a remote control,  
but only one button:*

*OFF !*



# Intro to Arduino: microcontrollers

*-- some of Mitch's projects --*

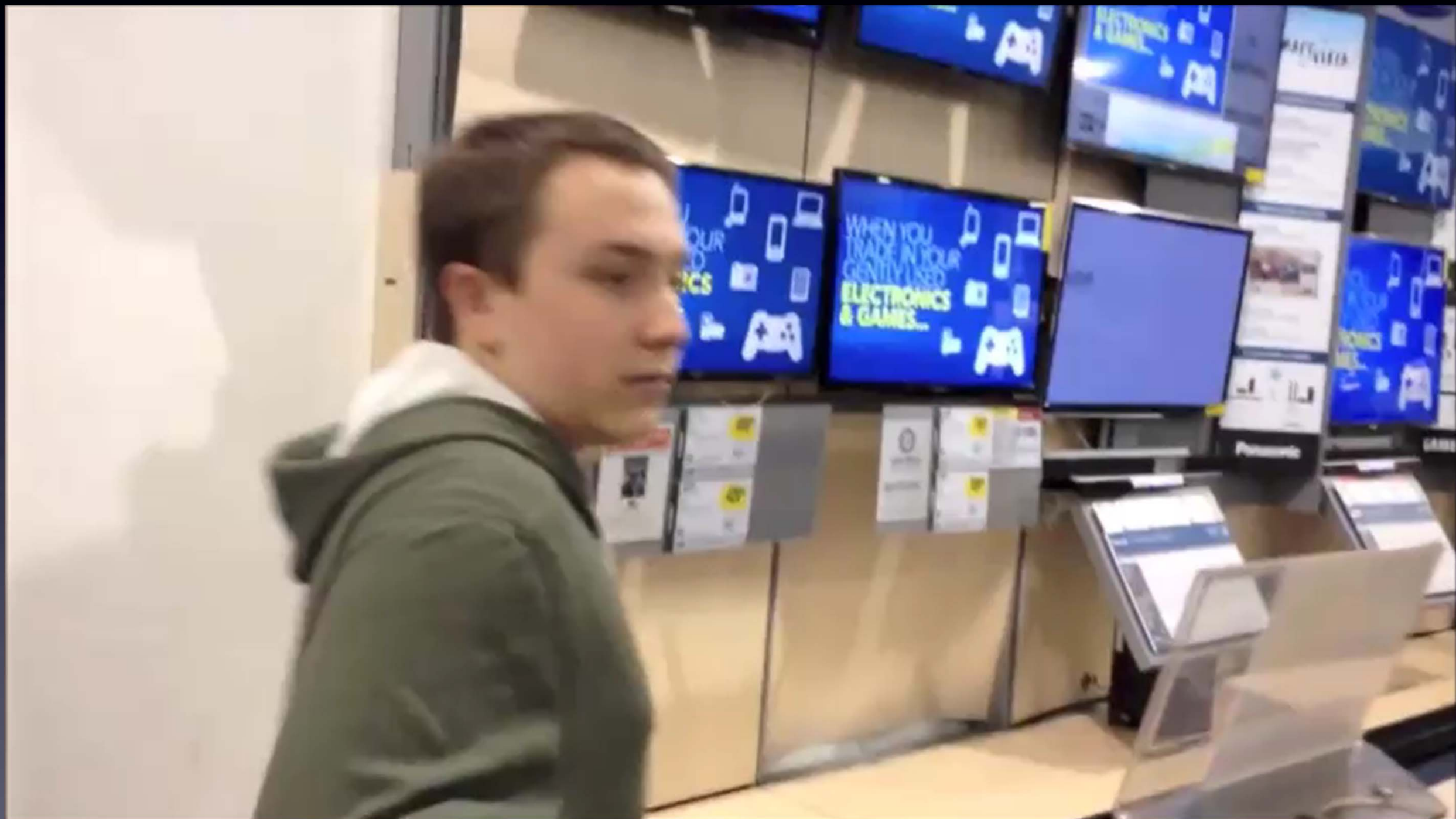

*TV-B-Gone*

# Intro to Arduino: microcontrollers

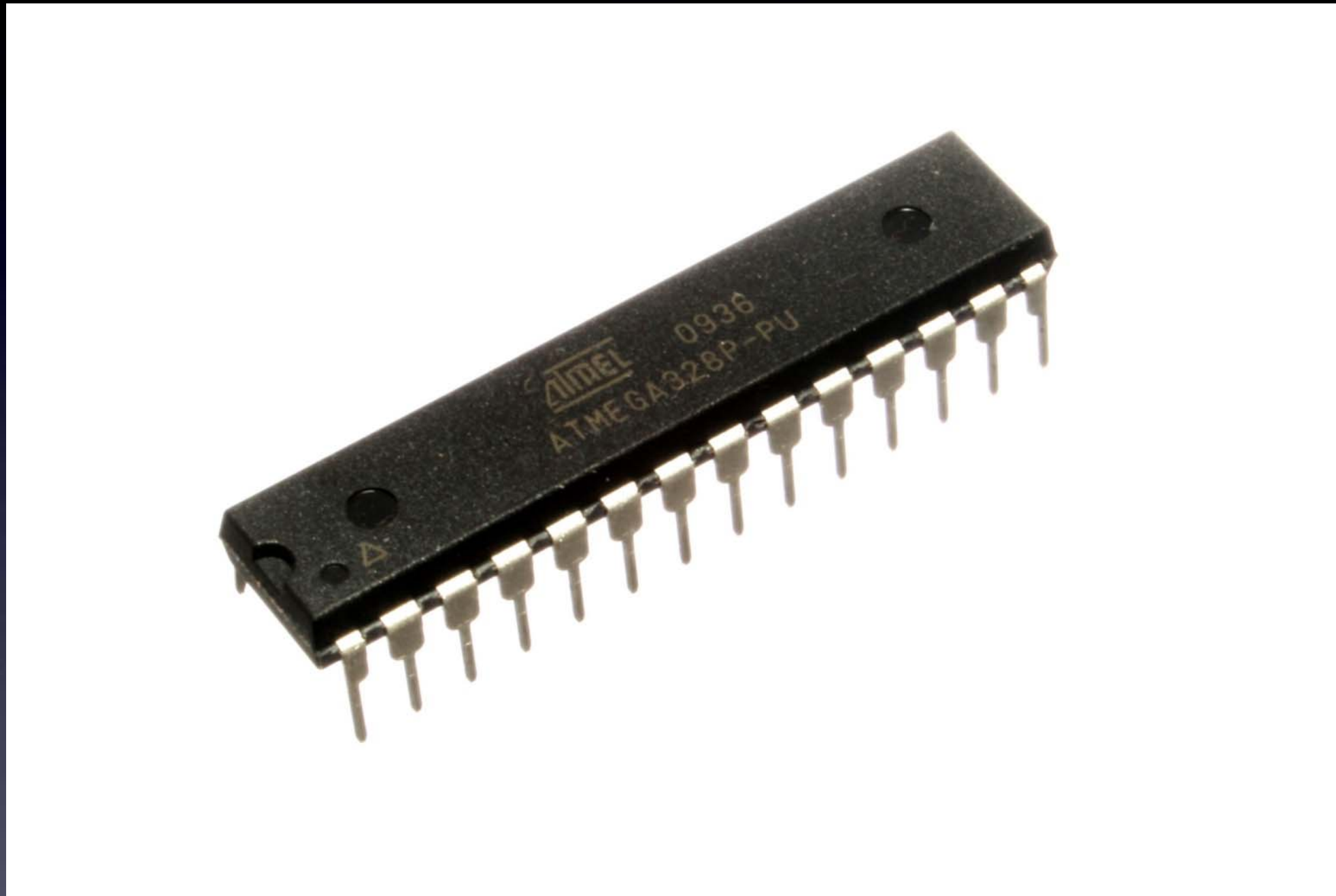

**A complete computer on a chip:**  
they control parts connected to their pins

# Intro to Arduino: microcontrollers

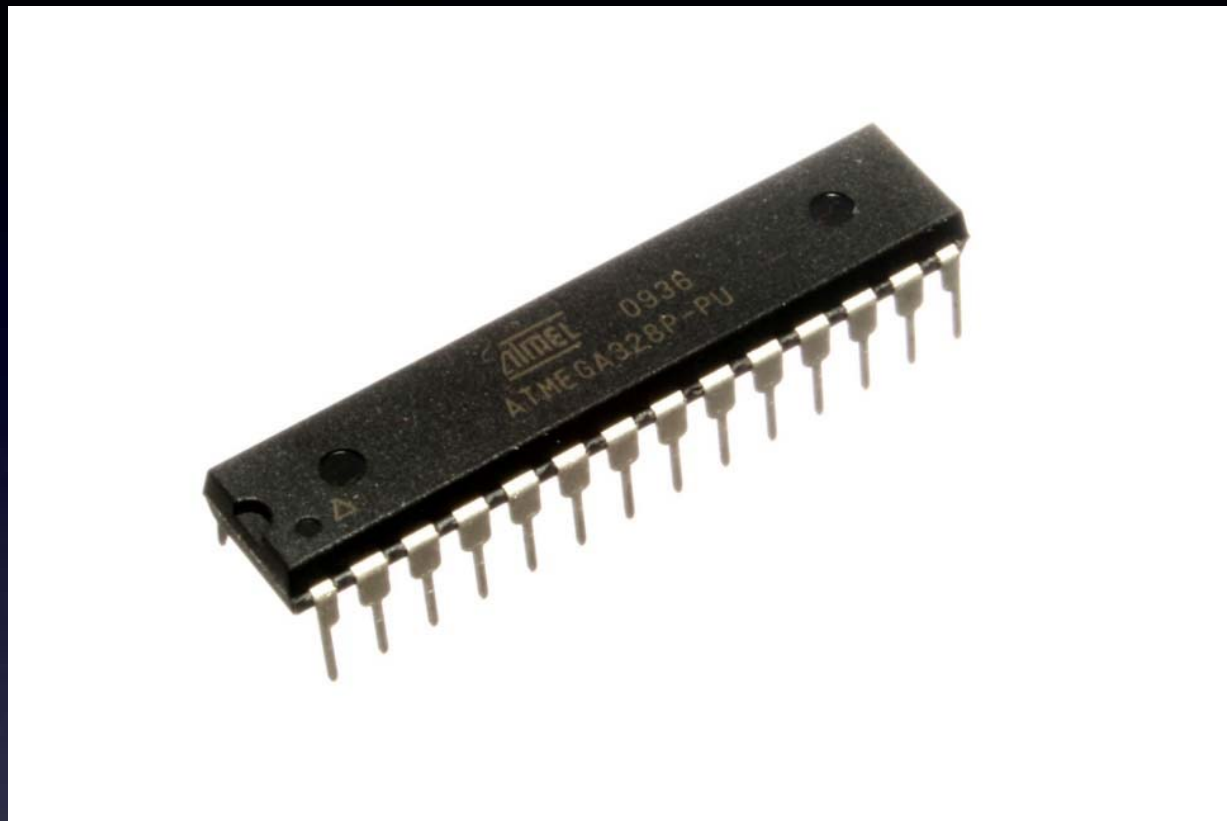

**A complete computer on a chip:**

they control parts connected to their pins

***But,***

How do you  
connect parts to its pins?

How do you  
create and upload a program  
to control the parts?

# Intro to Arduino: microcontrollers

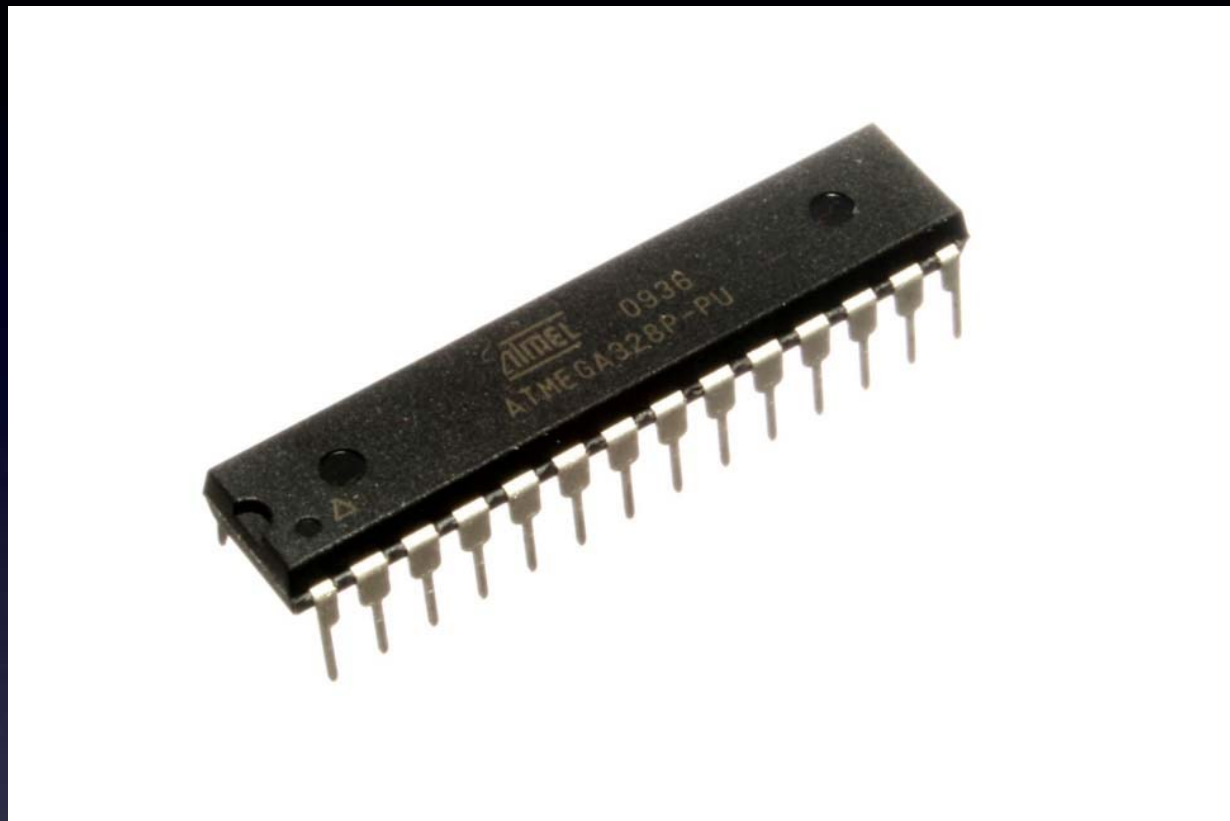

**A complete computer on a chip:**

they control parts connected to their pins

***But,***

How do you  
connect parts to its pins?

How do you  
create and upload a program  
to control the parts?

***Answer:*** *Be a geek, and learn how!*

Or

# Intro to Arduino



*Use an Arduino board*

# Intro to Arduino



*Use an Arduino board*

Super easy to connect parts to its microcontroller's pins

Super easy to create and upload a program to control the parts



# Intro to Arduino

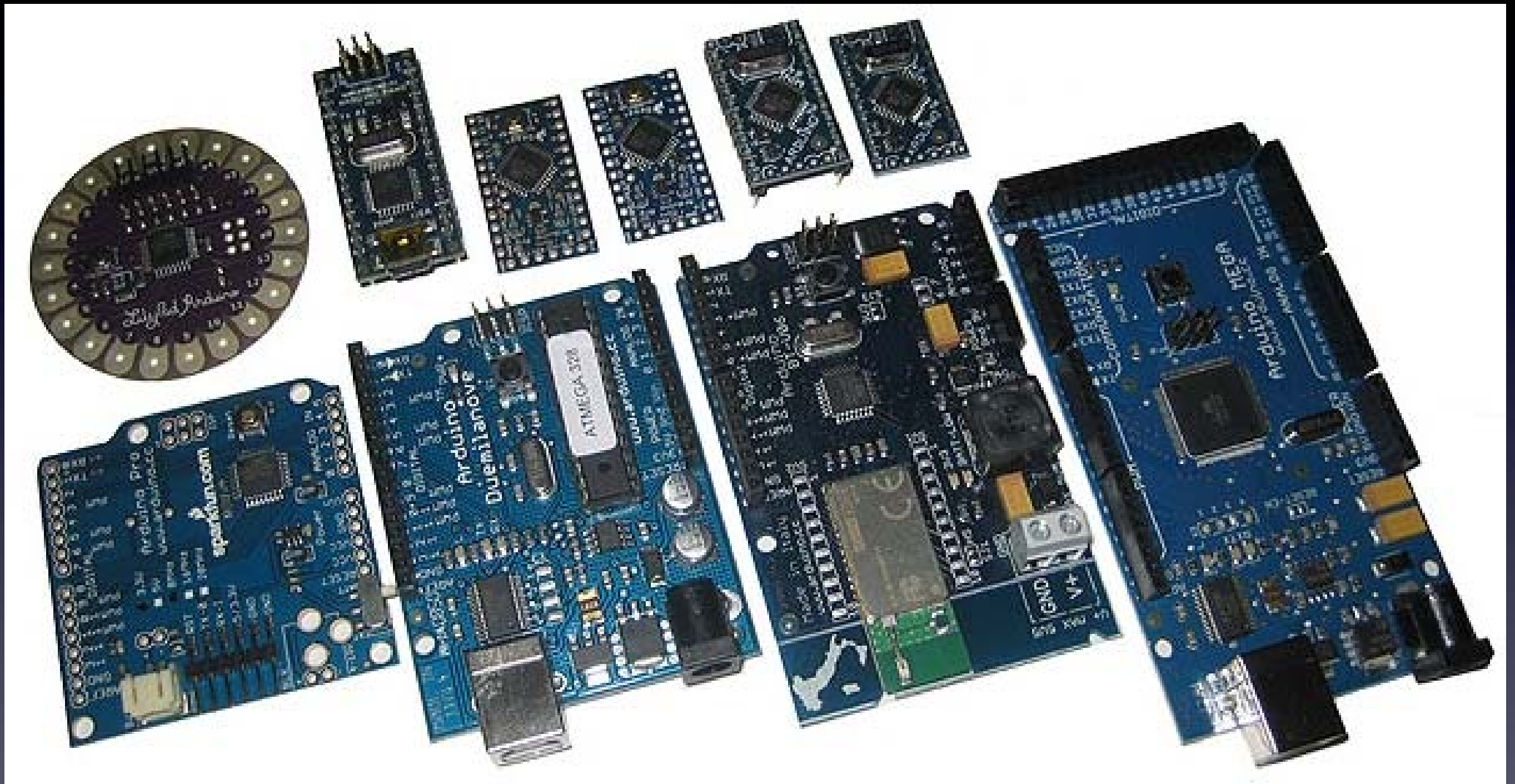

*Many Arduino boards to choose from*

# Intro to Arduino

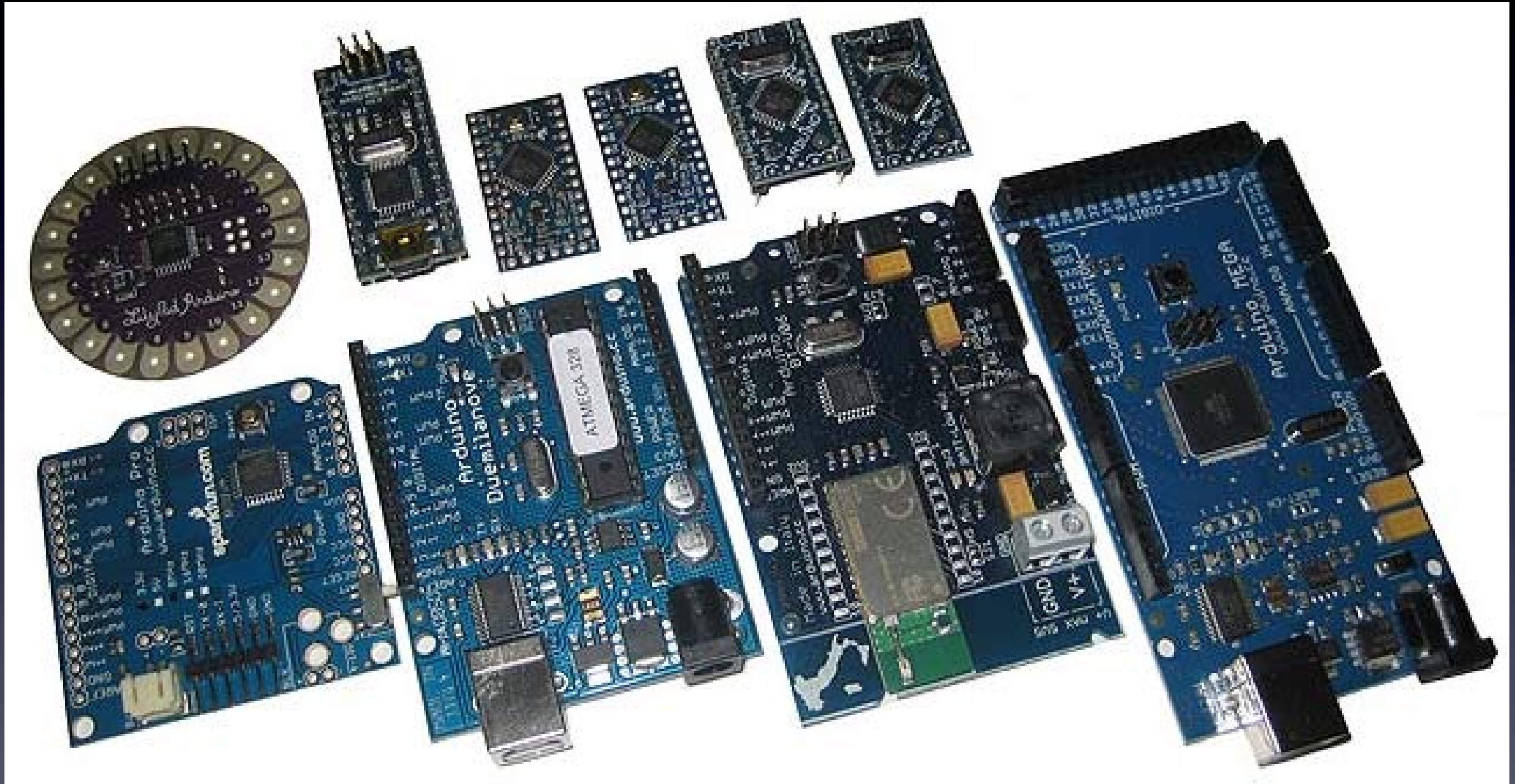

Open Source

# Intro to Arduino

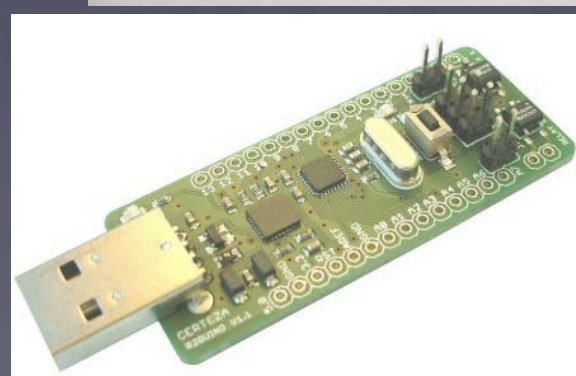
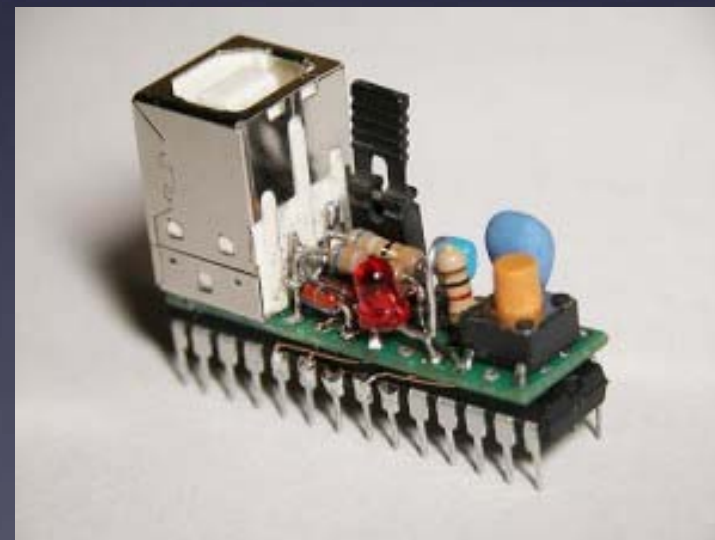
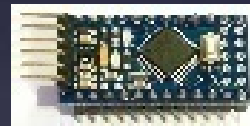
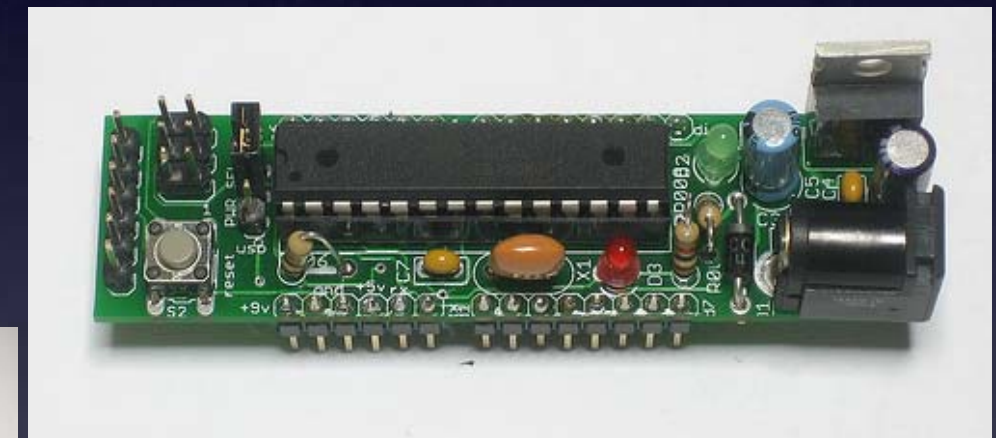
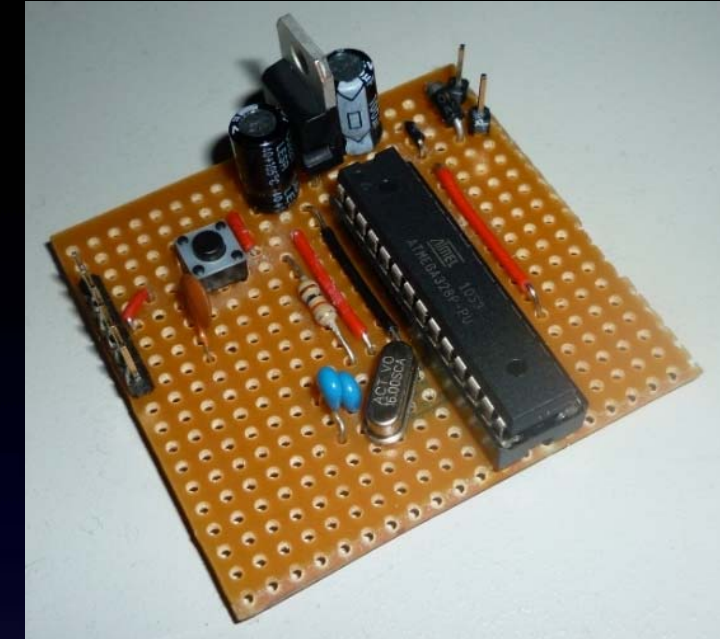
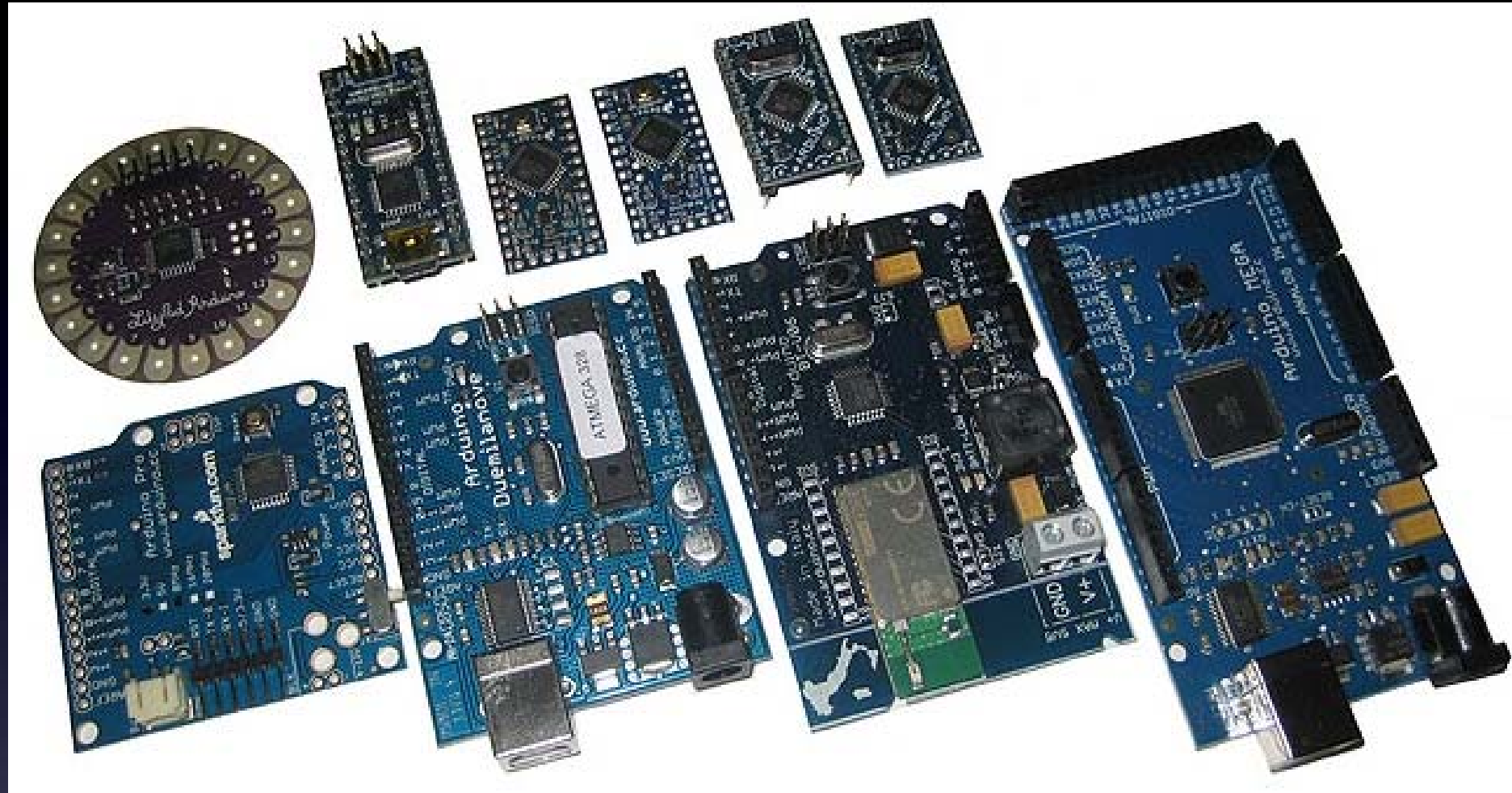

Open Source

# Intro to Arduino

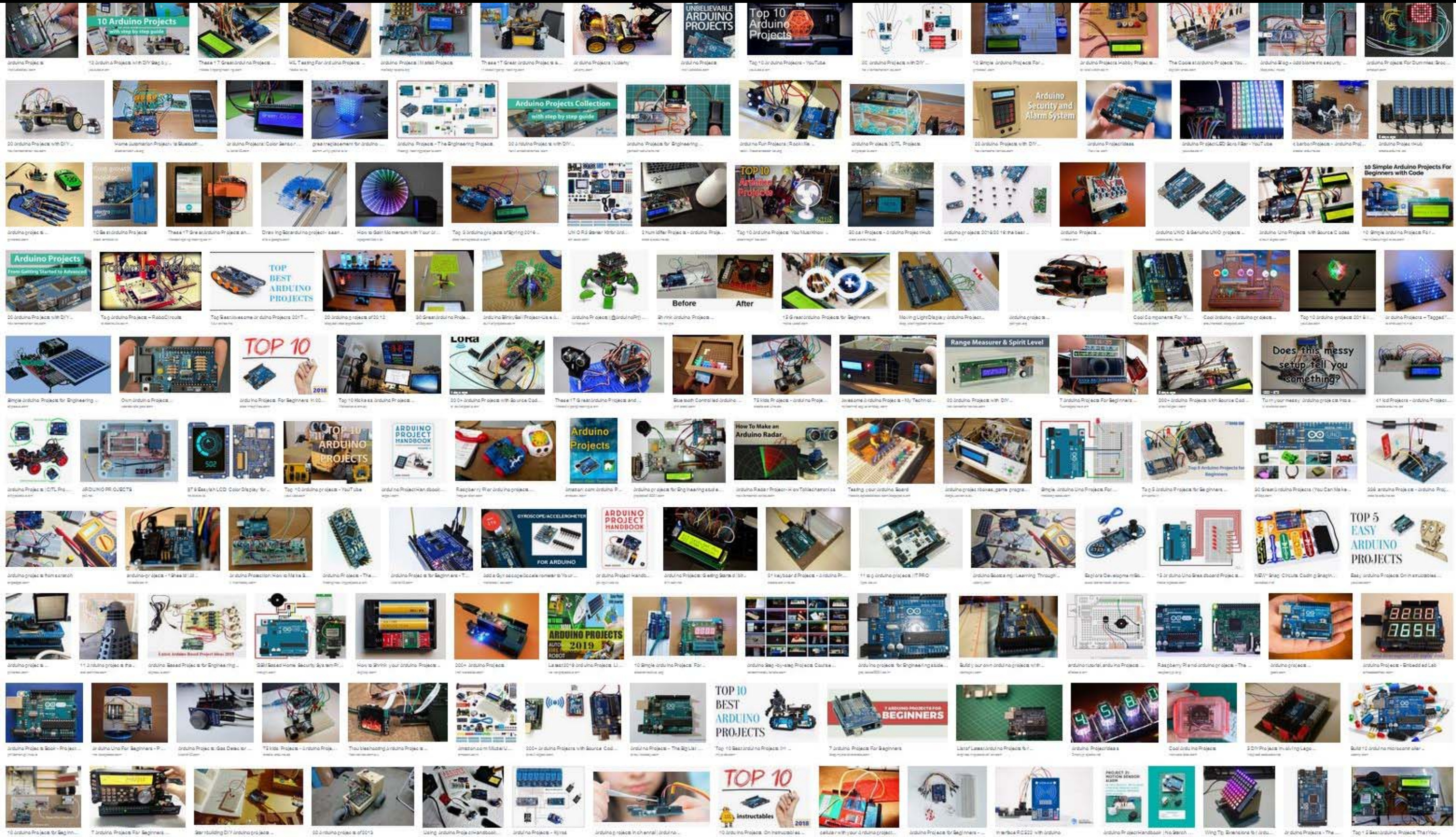

*hundreds of thousands of projects online!*

# Intro

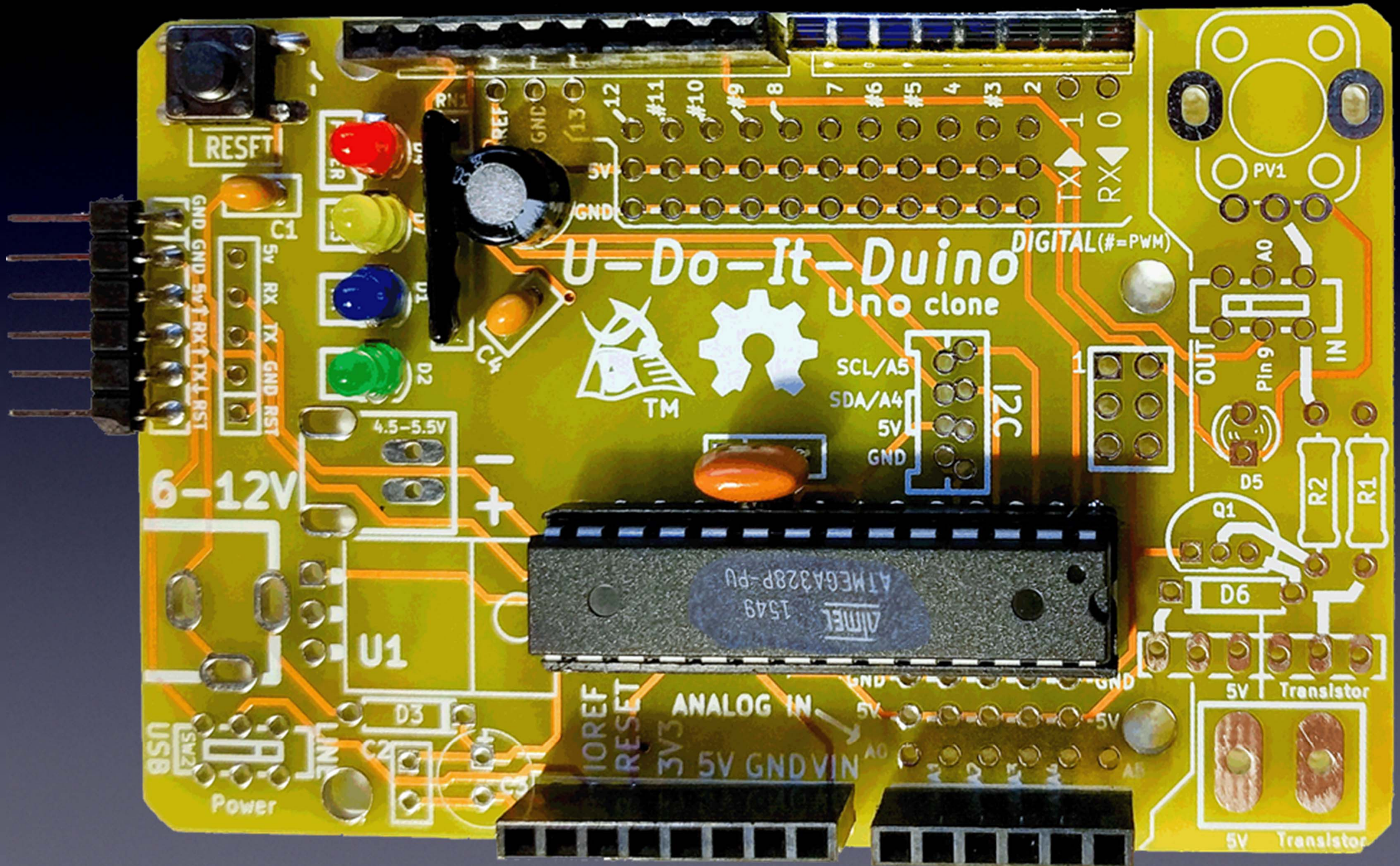

Intro

Questions?

# *Everything You Need to Know About Electronics*

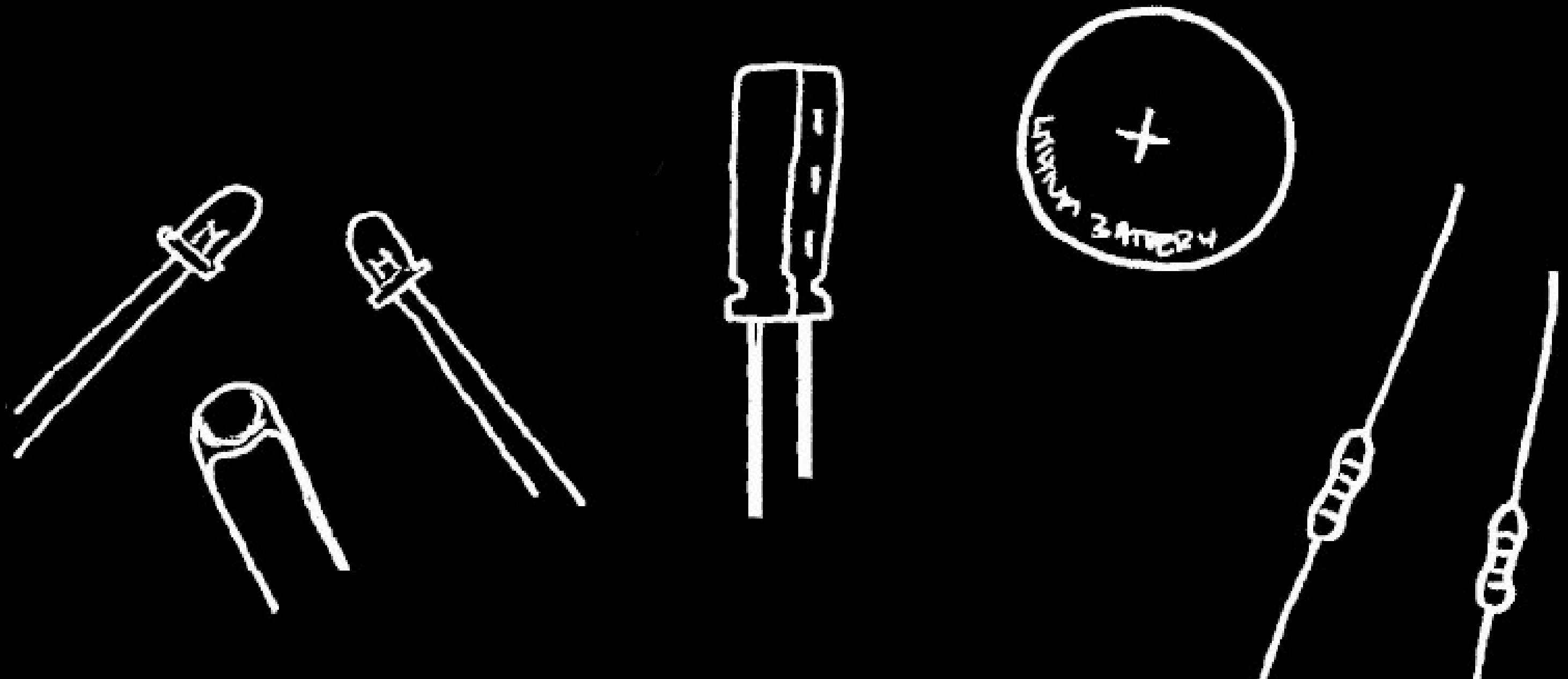

# Everything You Need to Know About Electronics

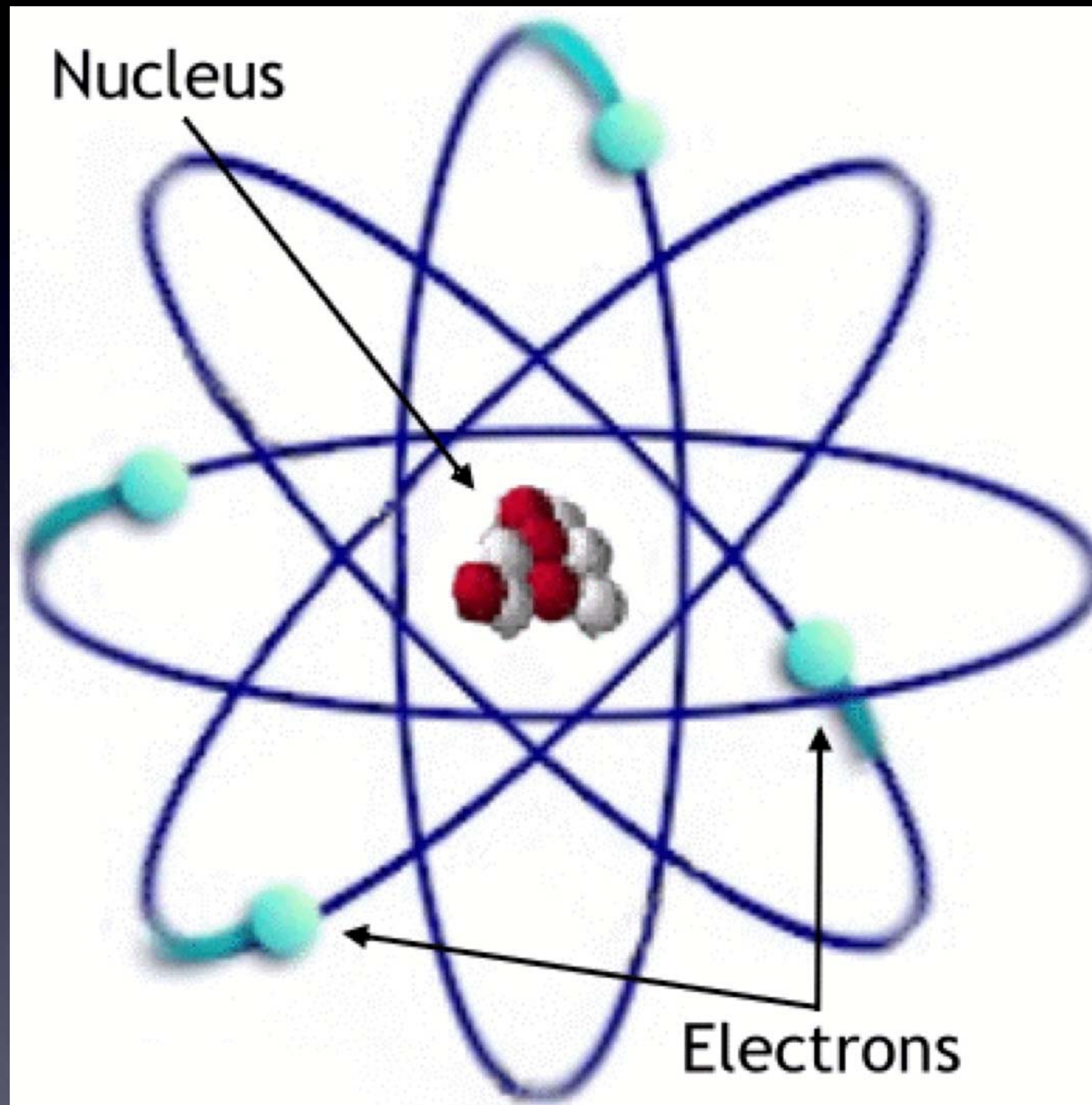

Electrons



# Everything You Need to Know About Electronics

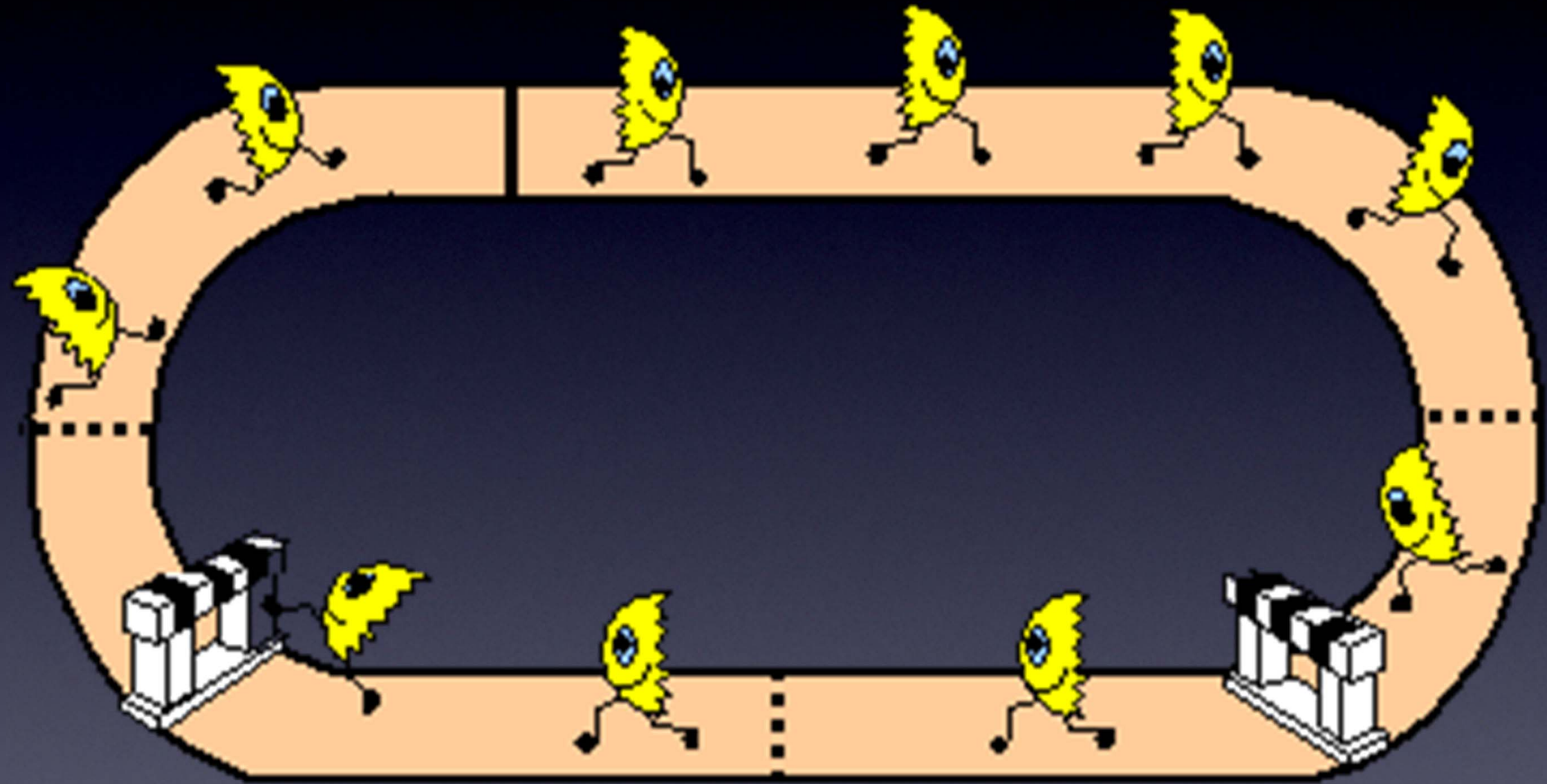

Circuit = Electrons going in complete circle = Magic!

# Everything You Need to Know About Electronics

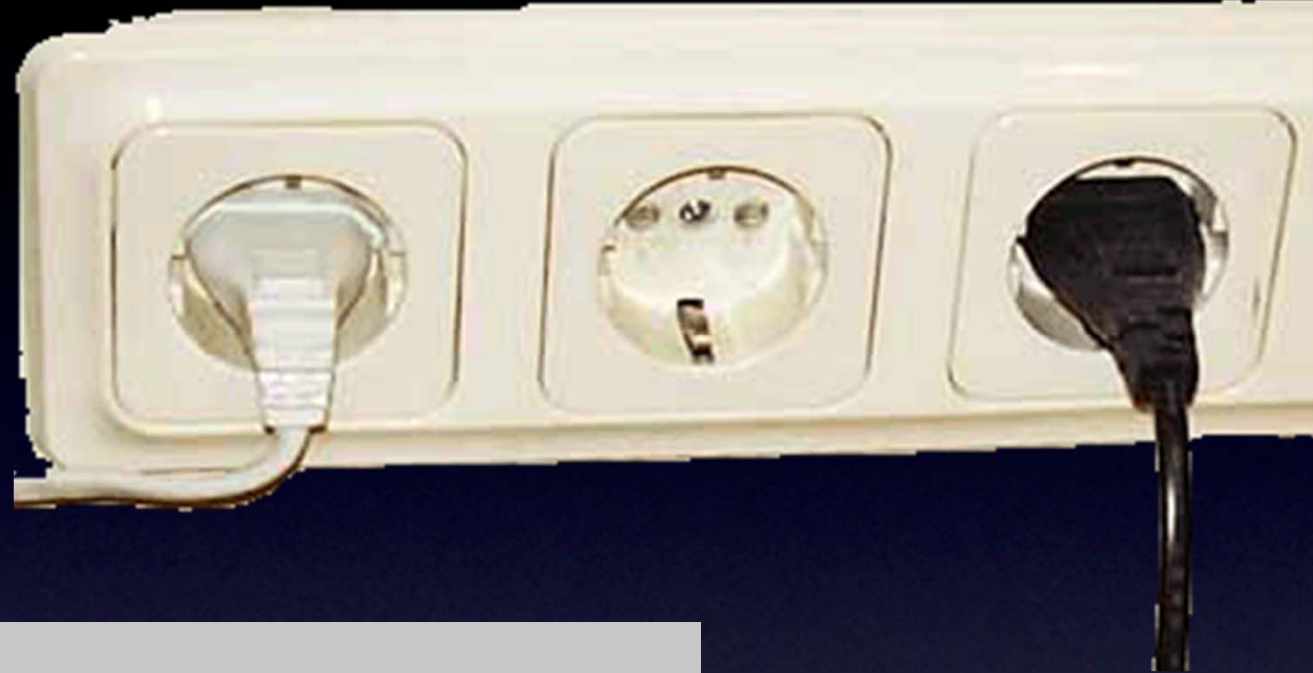

## Power Supplies

# Everything You Need to Know About Electronics

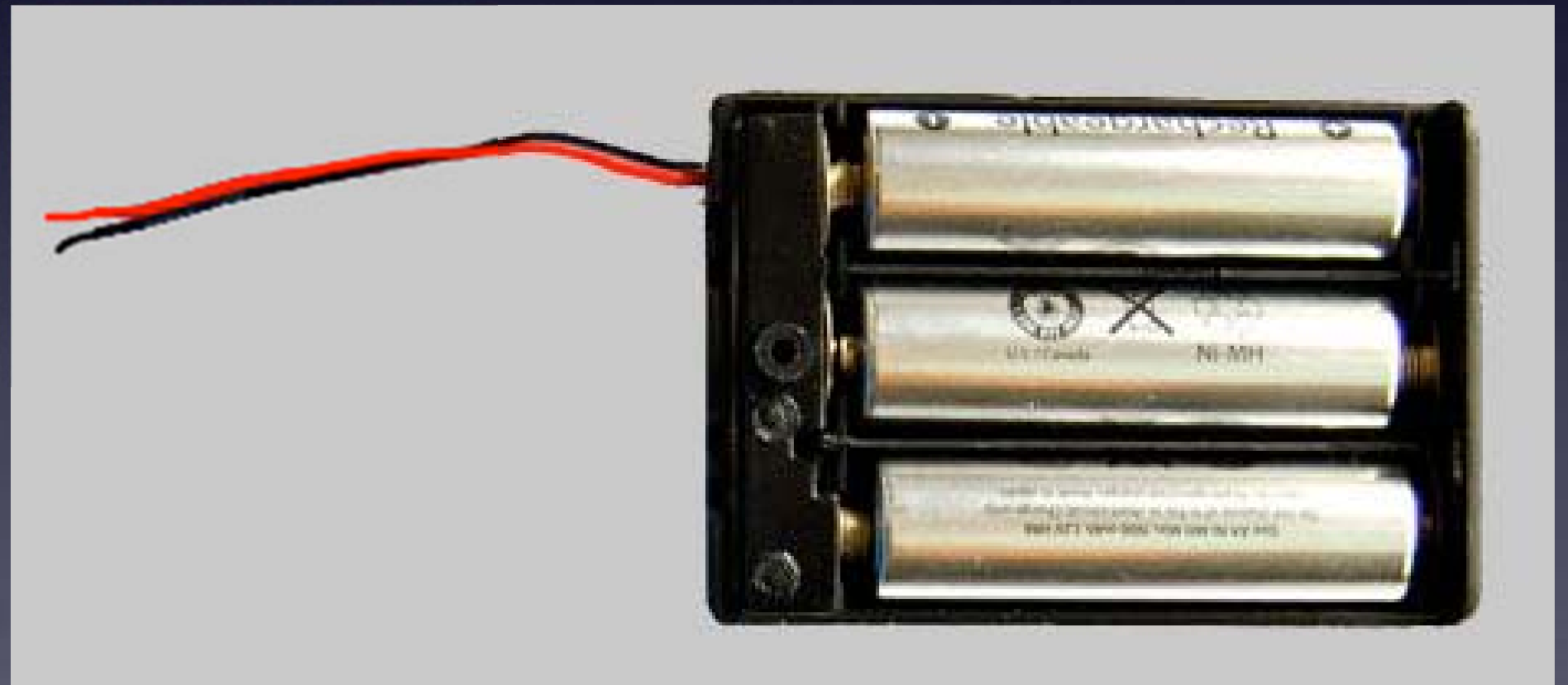

**Volts** / Voltage

# Everything You Need to Know About Electronics

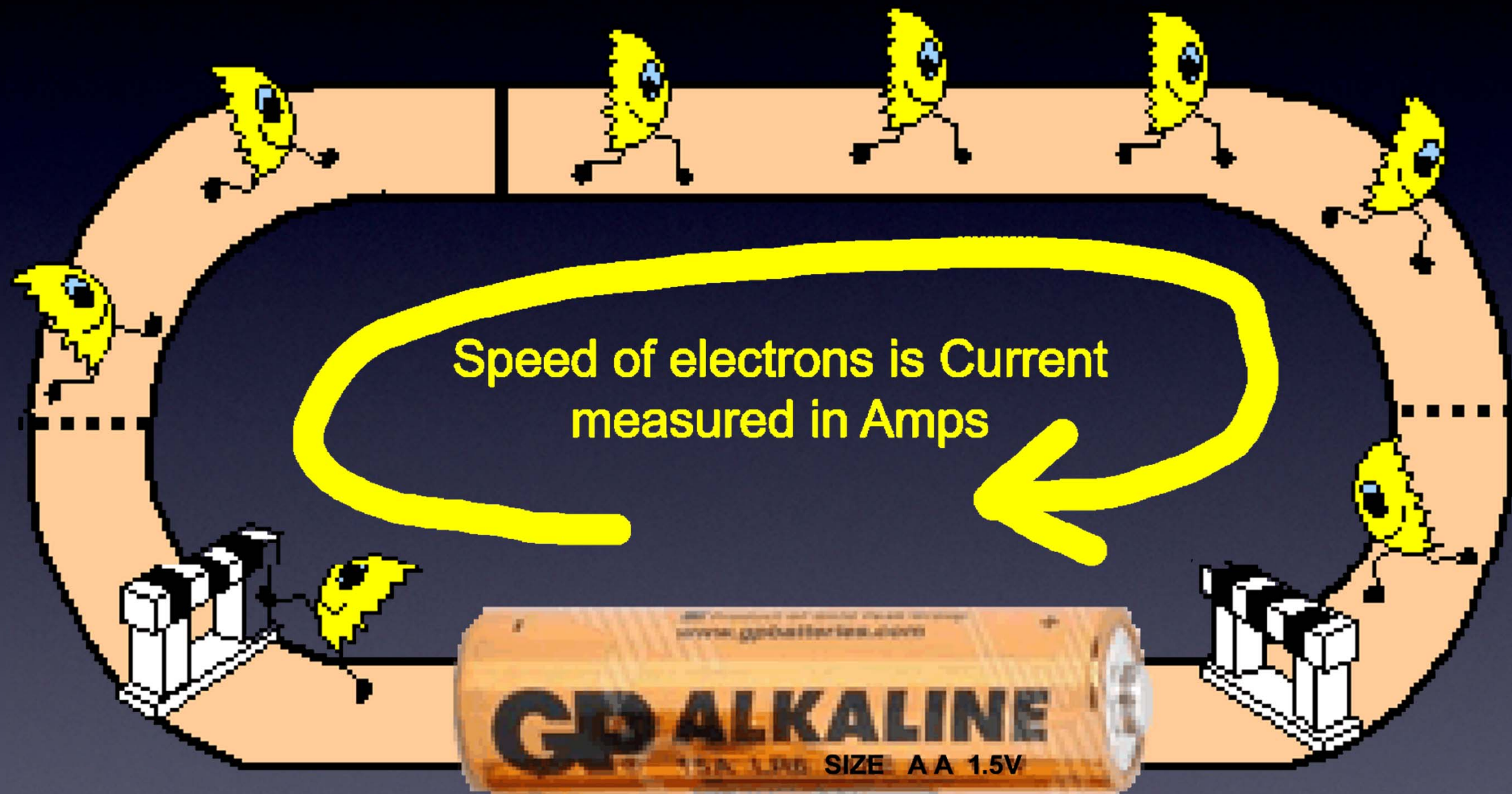

Electrons pushed with 1.5V.  
So, they move!

**Amps** / Current

# Everything You Need to Know About Electronics

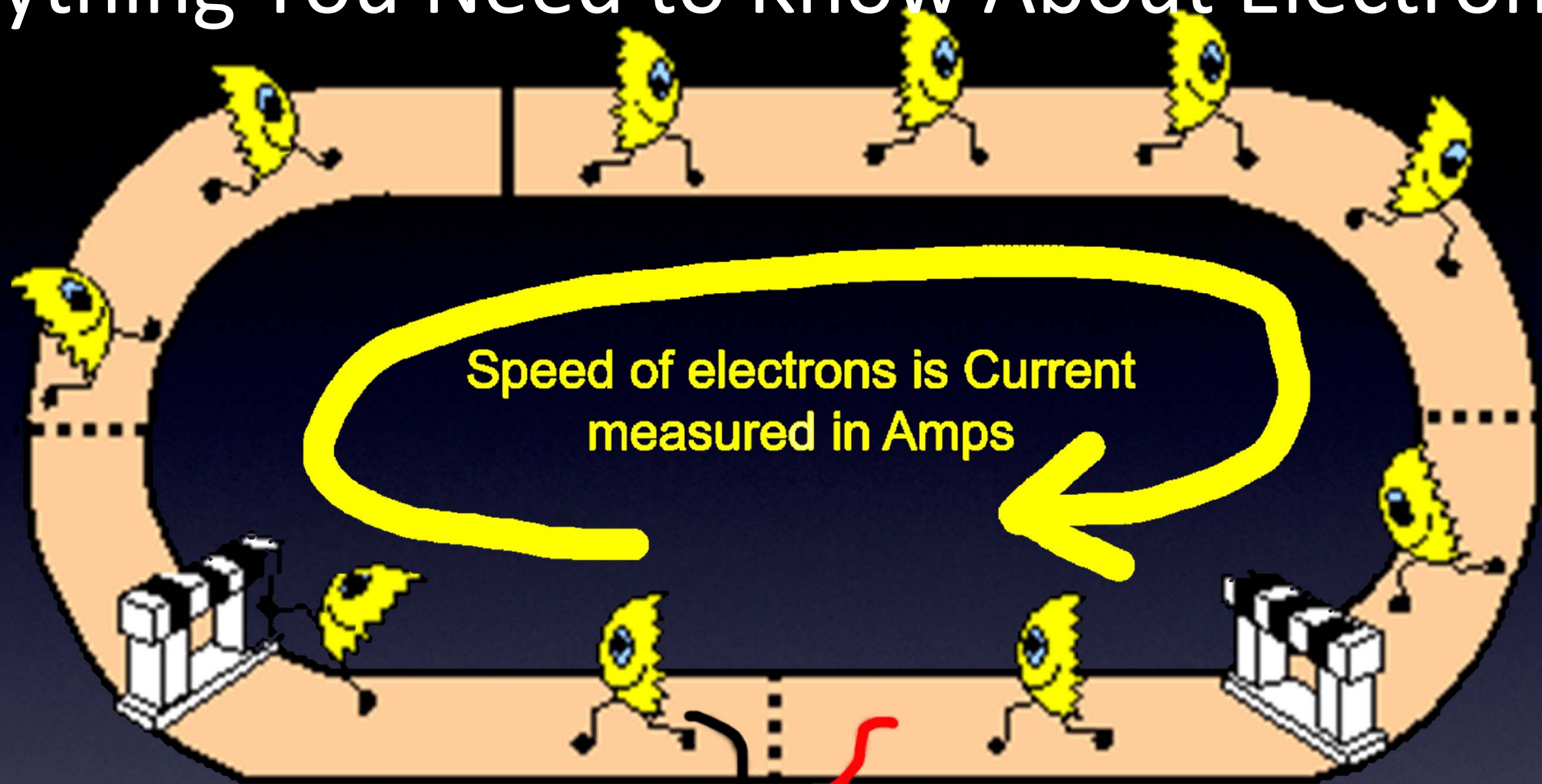

3 times more Volts  
3 times more push  
3 times faster electrons  
3 times more current / Amps

Amps / Current

# Everything You Need to Know About Electronics

**Too much energy?**

**Lots of energy!**

Amps / Current

# Everything You Need to Know About Electronics

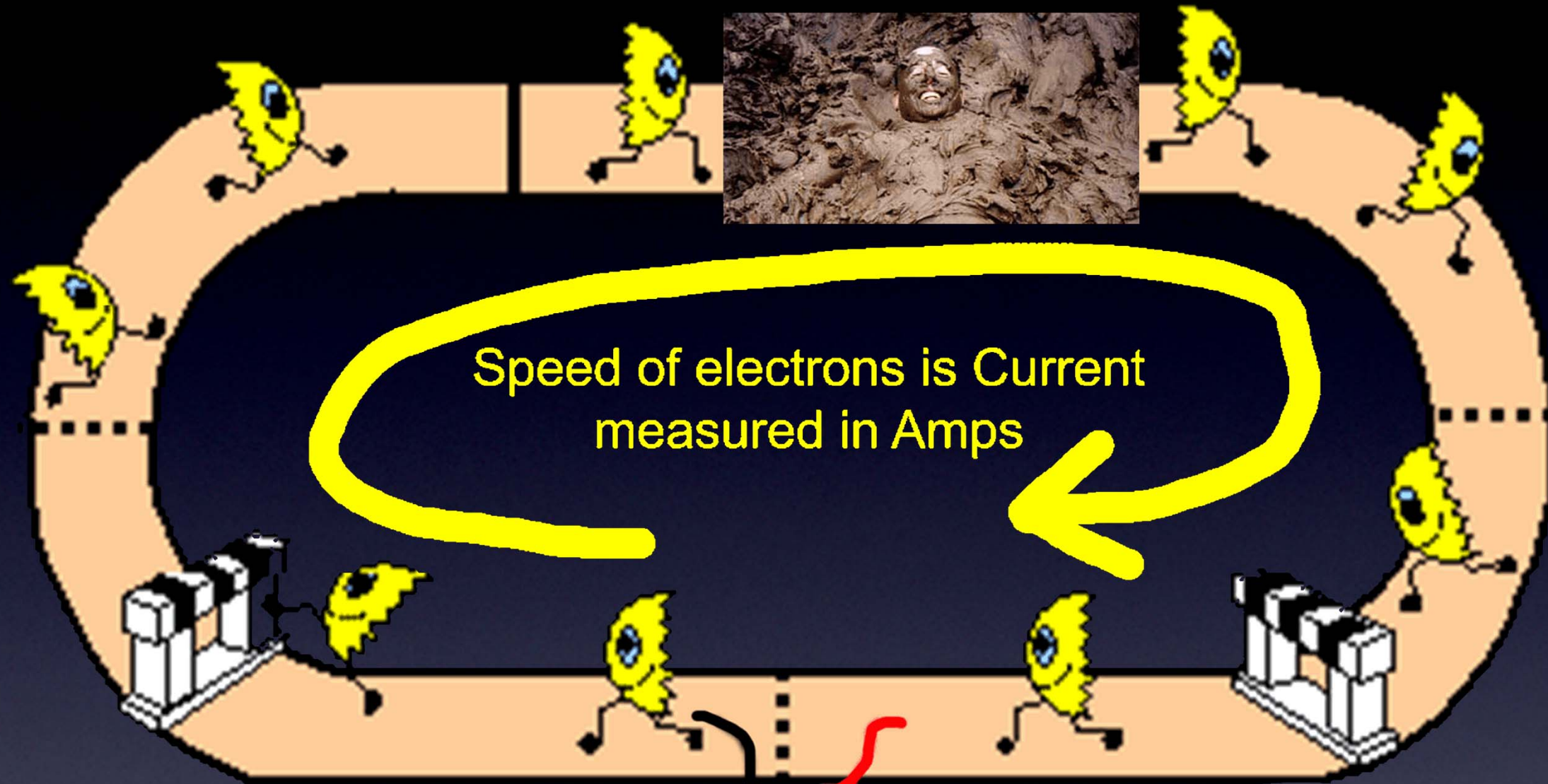

Resistance in the electrons' path slows them down, which means less current (less Amps).



Resistance / **Ohms**

# Everything You Need to Know About Electronics

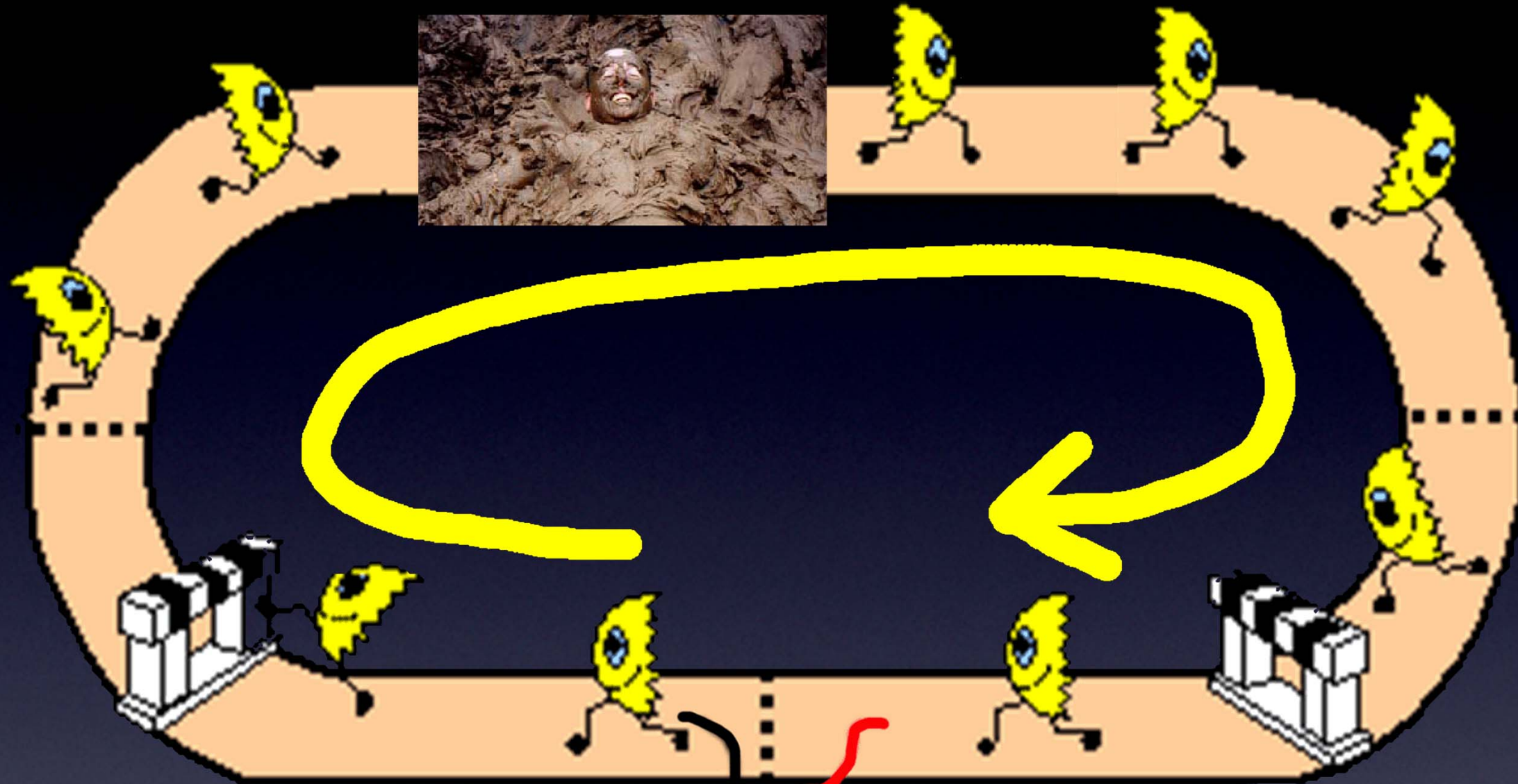

Resistance / Ohms

Same  
Circuit!



# Everything You Need to Know About Electronics

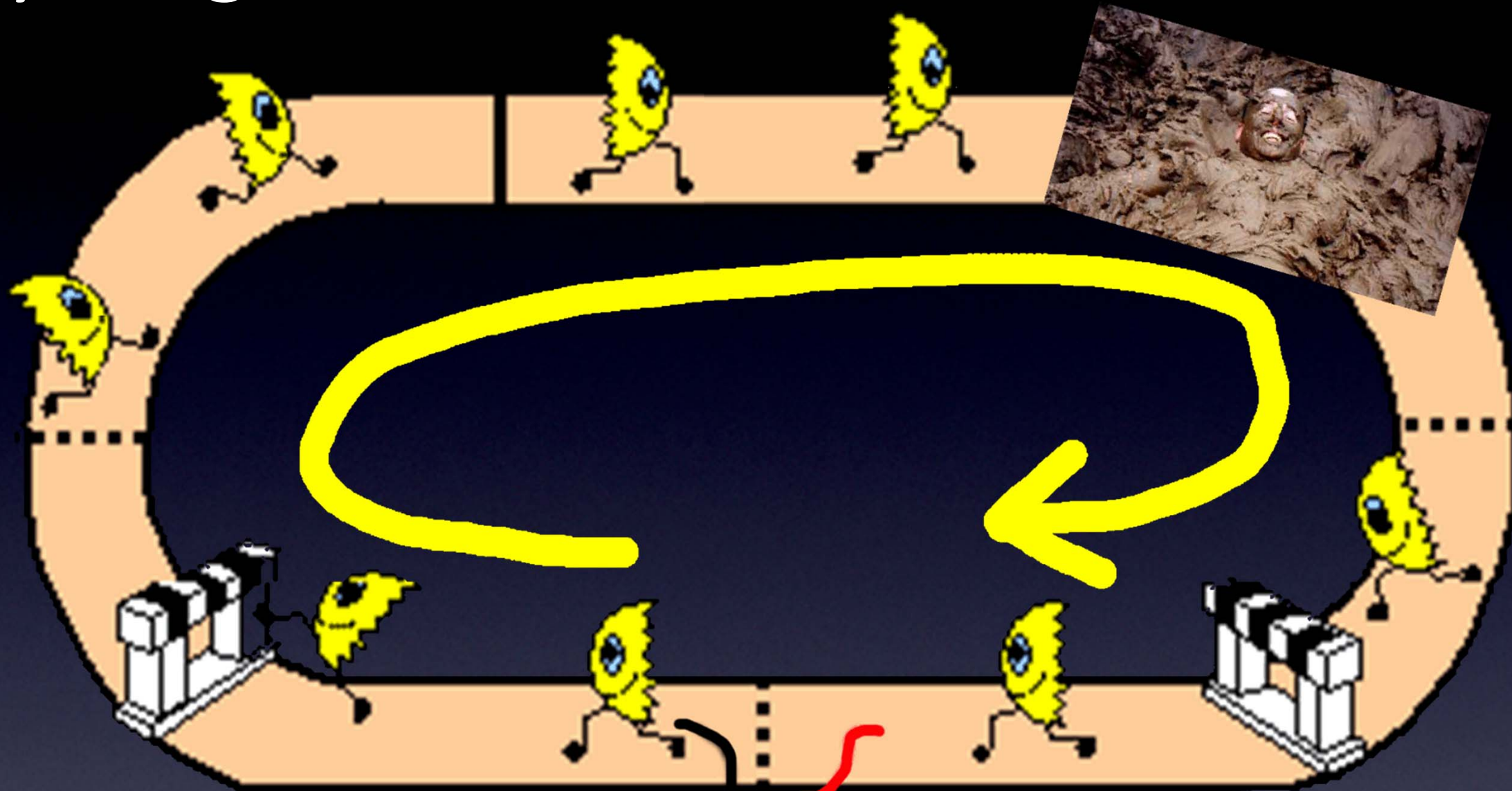

Resistance / Ohms

Same  
Circuit!

# Everything You Need to Know About Electronics

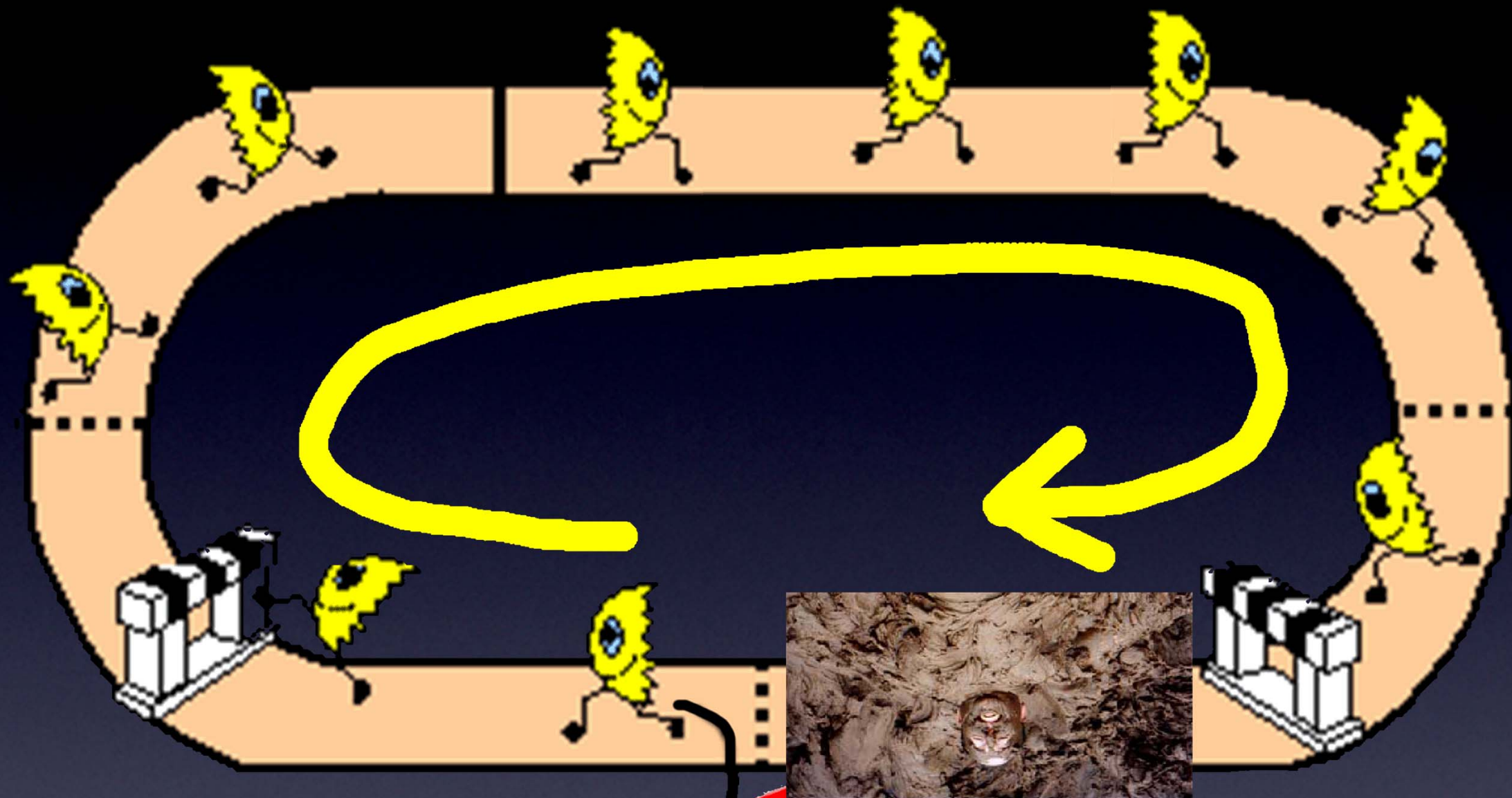

Resistance / Ohms

Same  
Circuit!

# Everything You Need to Know About Electronics

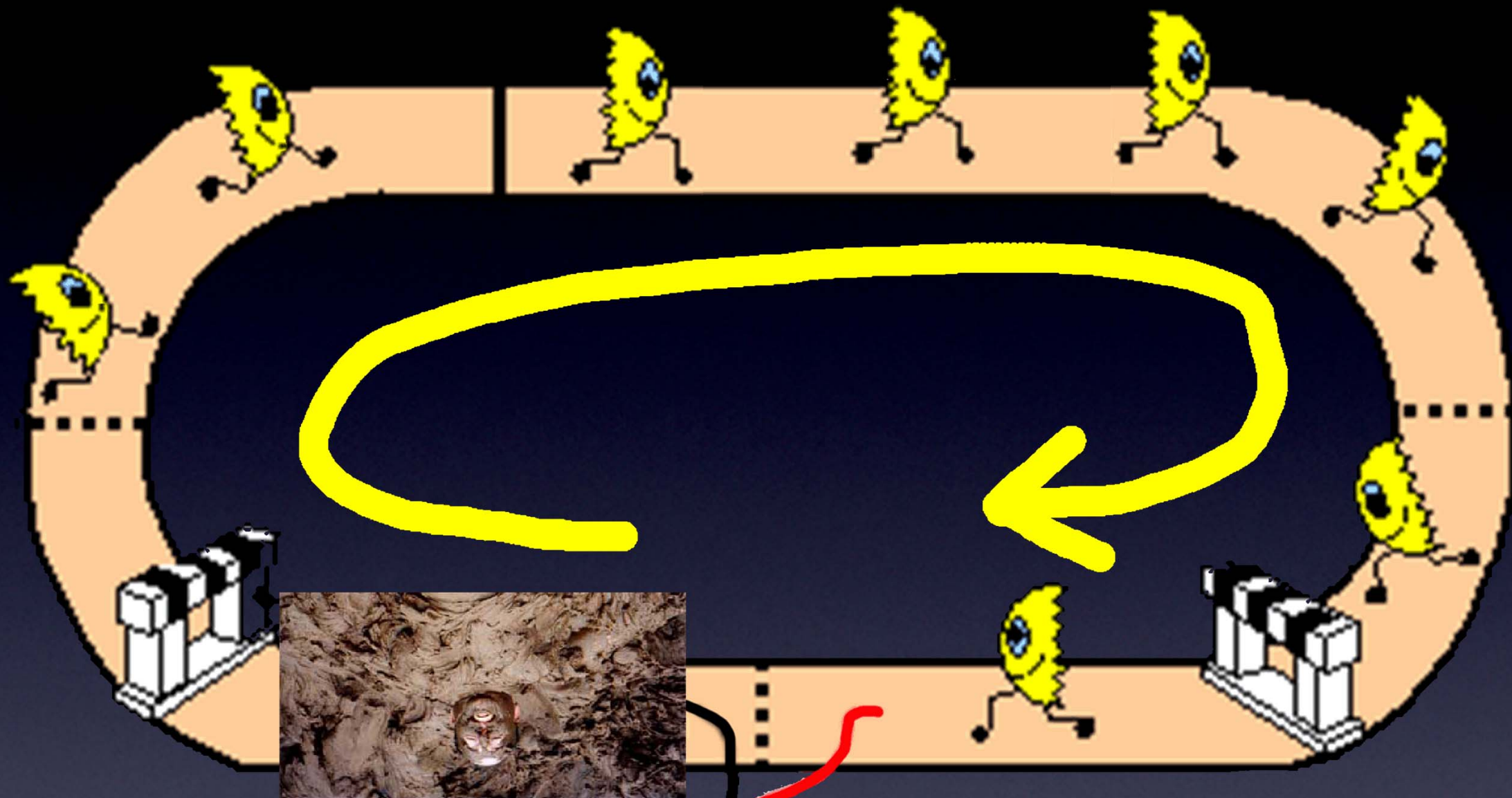

Resistance / Ohms

Same  
Circuit!

# Everything You Need to Know About Electronics

## Ohm's Law

**Volts** -- *force* pushing electrons

**Amps** -- *speed* of electrons

**Ohms** -- *Resistance* to flow of electrons

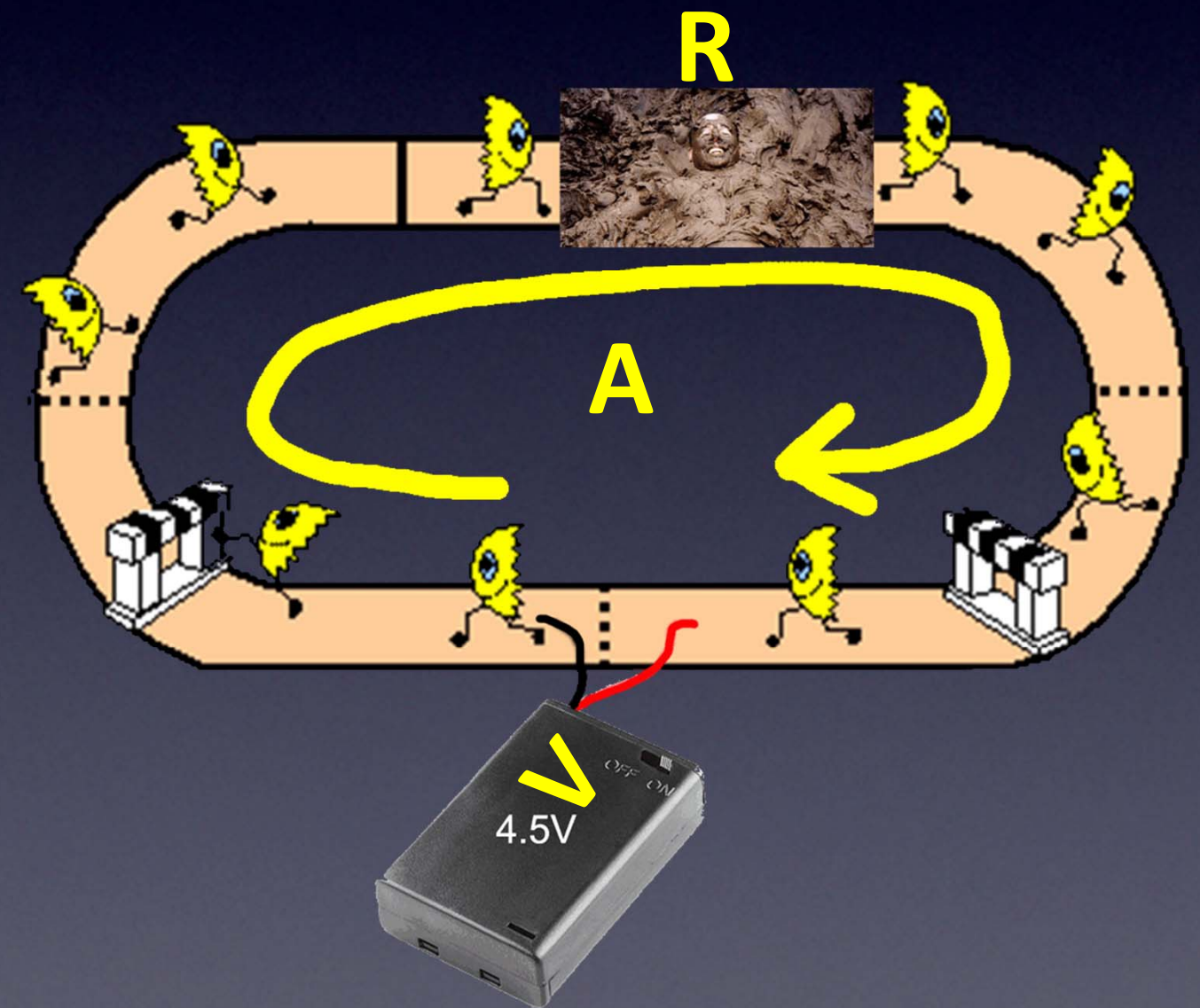

# Everything You Need to Know About Electronics

## Ohm's Law

**Volts** -- *force* pushing electrons

**Amps** -- *speed* of electrons

**Ohms** -- *Resistance* to flow of electrons

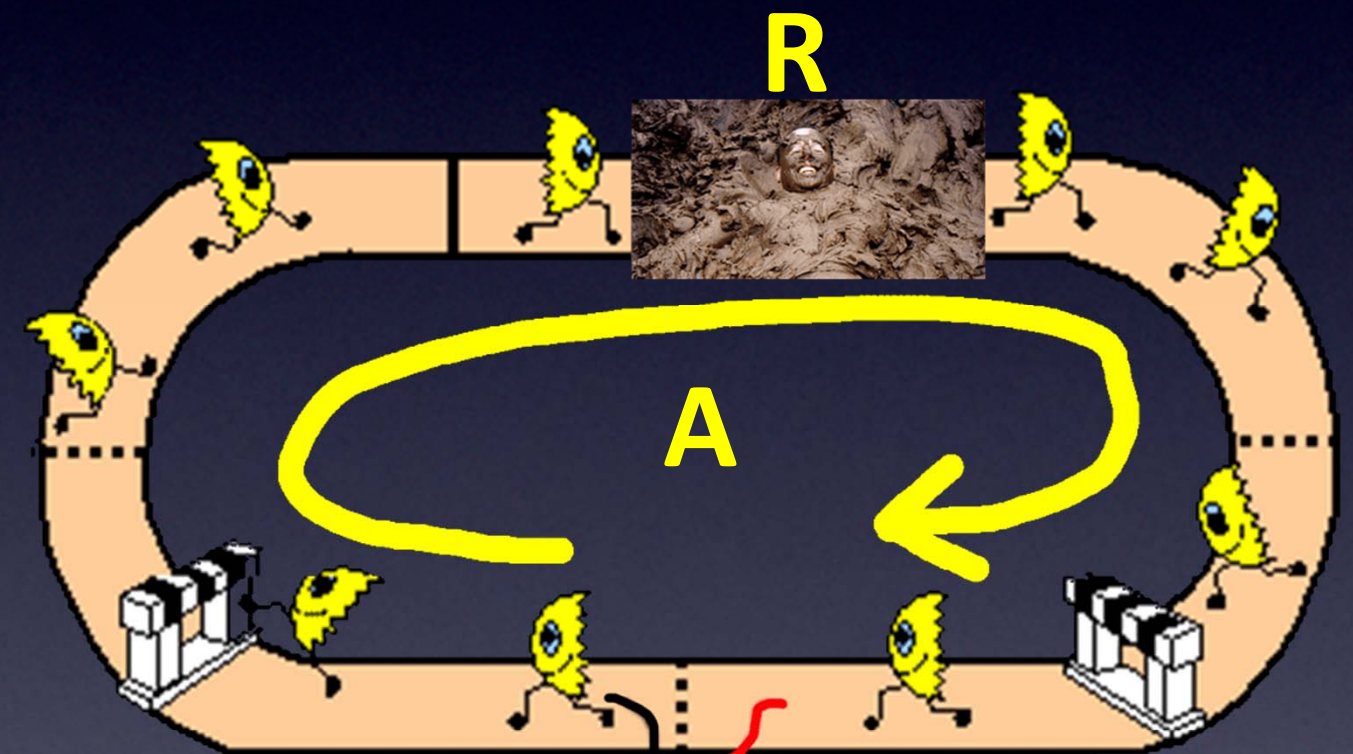

$$\mathbf{V} \text{olts} = \mathbf{A} \text{mps} \times \mathbf{R}$$

(Ohms)

# Everything You Need to Know About Electronics

## Ohm's Law

**Volts** -- *force* pushing electrons

**Amps** -- *speed* of electrons

**Ohms** -- *Resistance* to flow of electrons

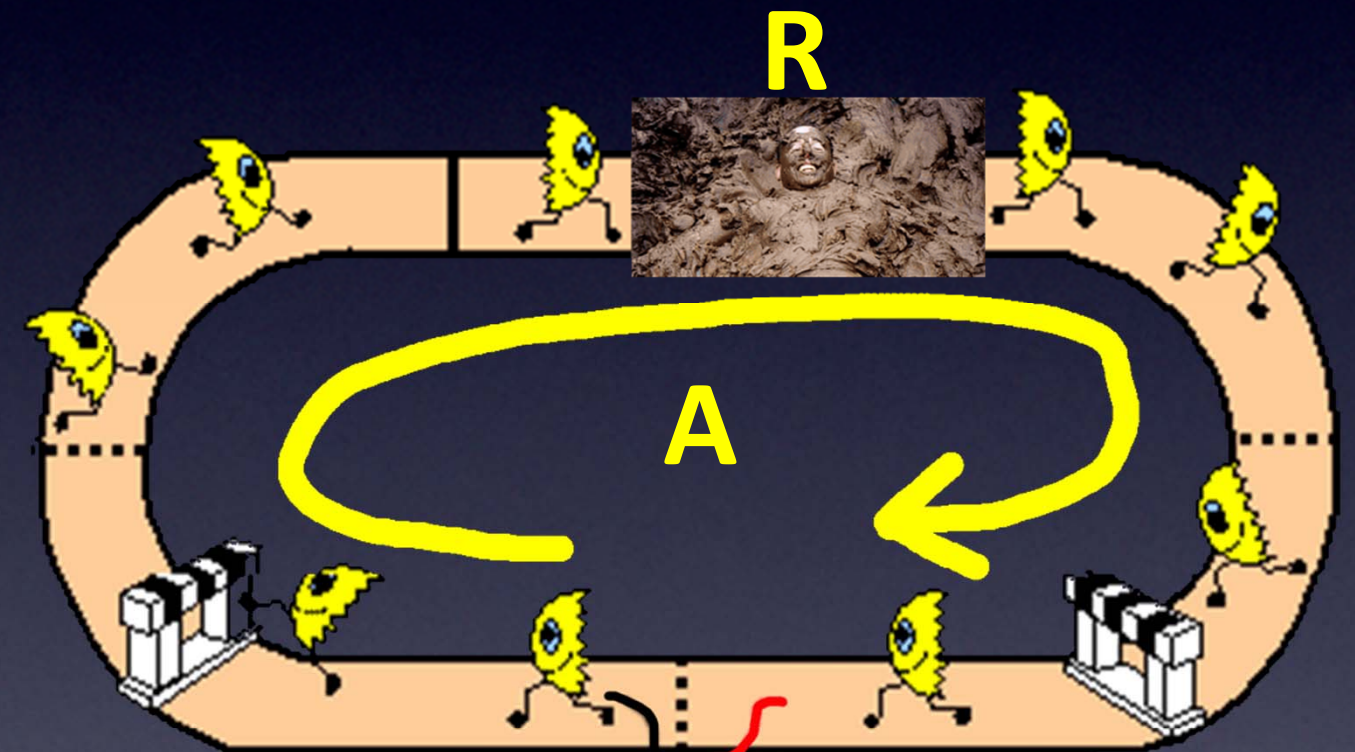

$$\text{Volts} = \text{Amps} \times R$$

Also commonly written:  $E = I \times R$

(Ohms)

# Everything You Need to Know About Electronics

The symbol for  
**Resistance:**

$\Omega$

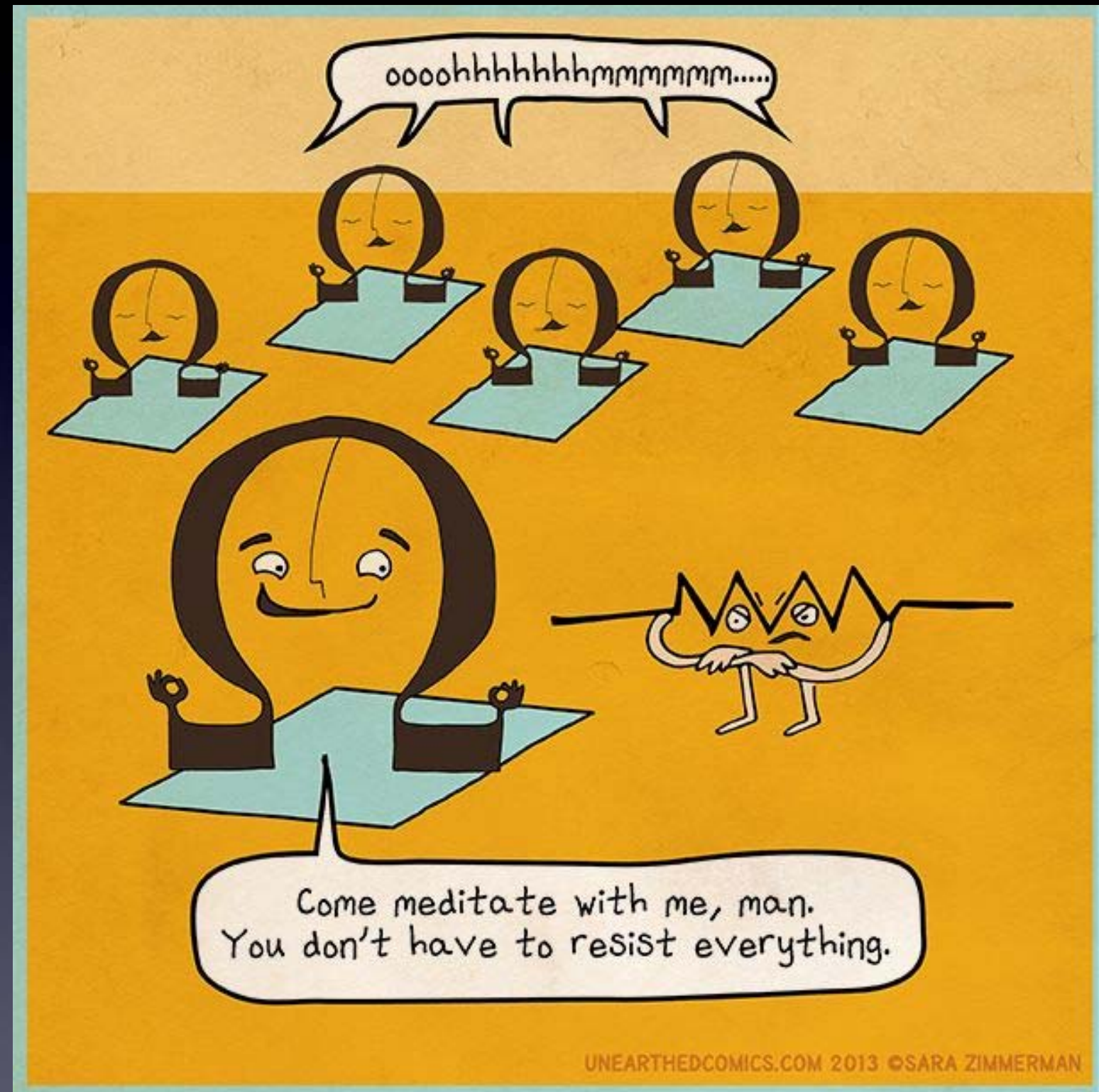

Resistors / Ohms

# Everything You Need to Know About Electronics

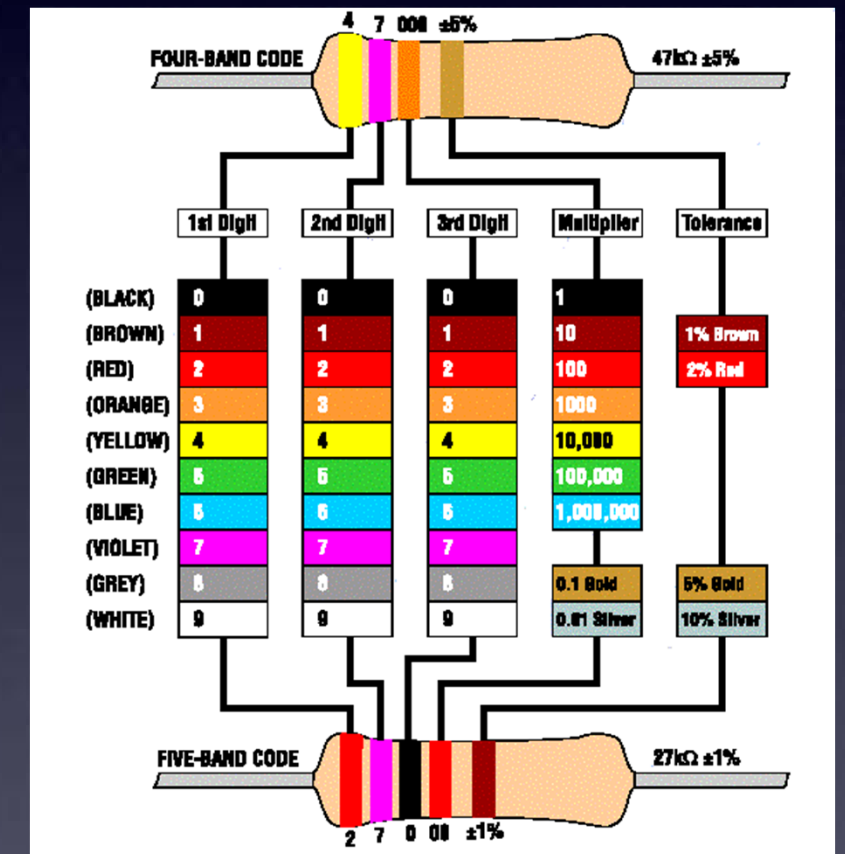
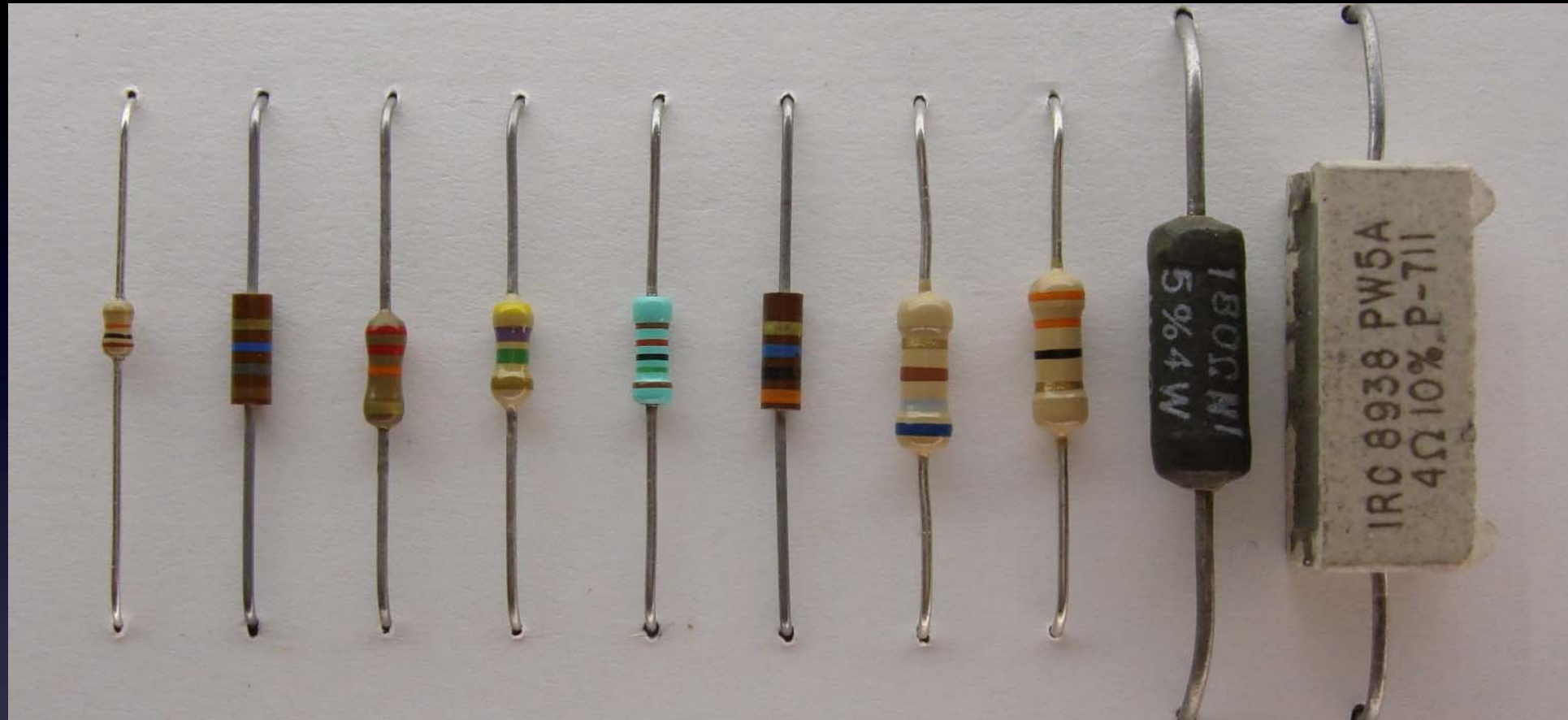

Resistors / Ohms



# Everything You Need to Know About Electronics



## What happens?

*polarity*

Power Supply – it matters how you connect it!

# Everything You Need to Know About Electronics

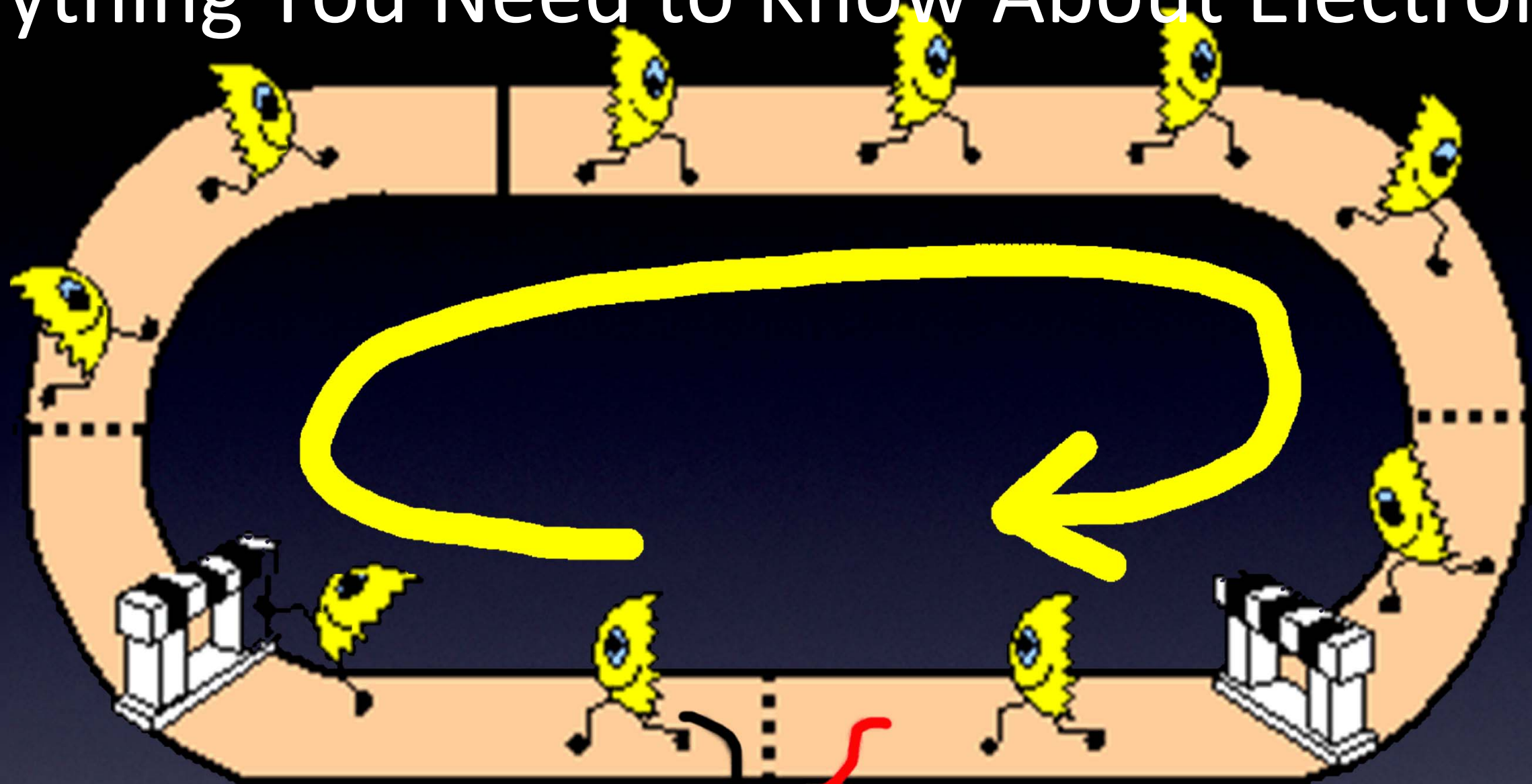

**Black Wire = “-”**

**Red Wire = “+”**



**Power Supply – it matters how you connect it!**

# Everything You Need to Know About Electronics



**Red wire:**  
**Power,**  
**Plus, Positive,**  
**4.5V,**  
**Vcc**

**Black wire:**  
**Minus, Negative,**  
**0V,**  
**Ground (GND)**

Power Supply – it matters how you connect it!

# Everything You Need to Know About Electronics

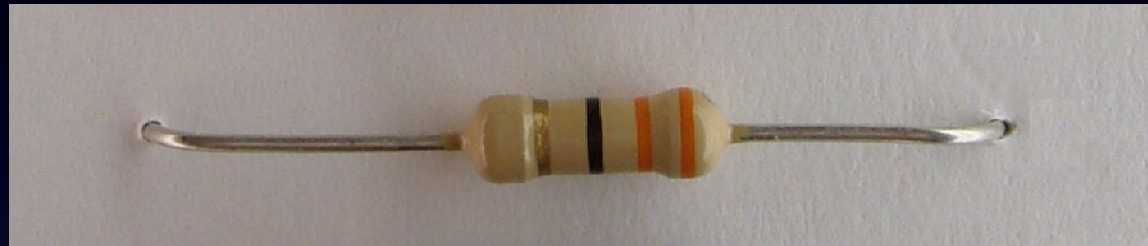

or



or



(electrons slowed down the same either way)

Resistors – it doesn't matter which way

# Everything You Need to Know About Electronics

**Minus / Negative side**

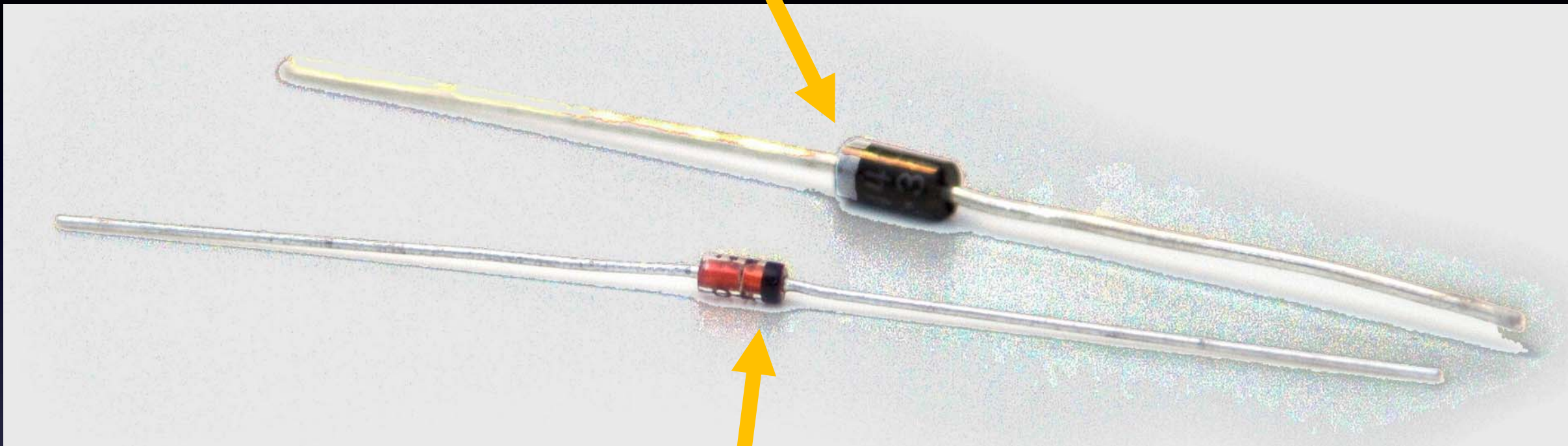

**Minus / Negative side**

**Diodes – One-Way valve for electrons**

Diodes – it matters which way!

# Everything You Need to Know About Electronics



**Short wire is Minus / Negative**

**Special kind of Diode – it Emits Light!**

LED – it matters which way!

# Everything You Need to Know About Electronics



Lots of different colored LEDs! (including IR)

LED

# Everything You Need to Know About Electronics

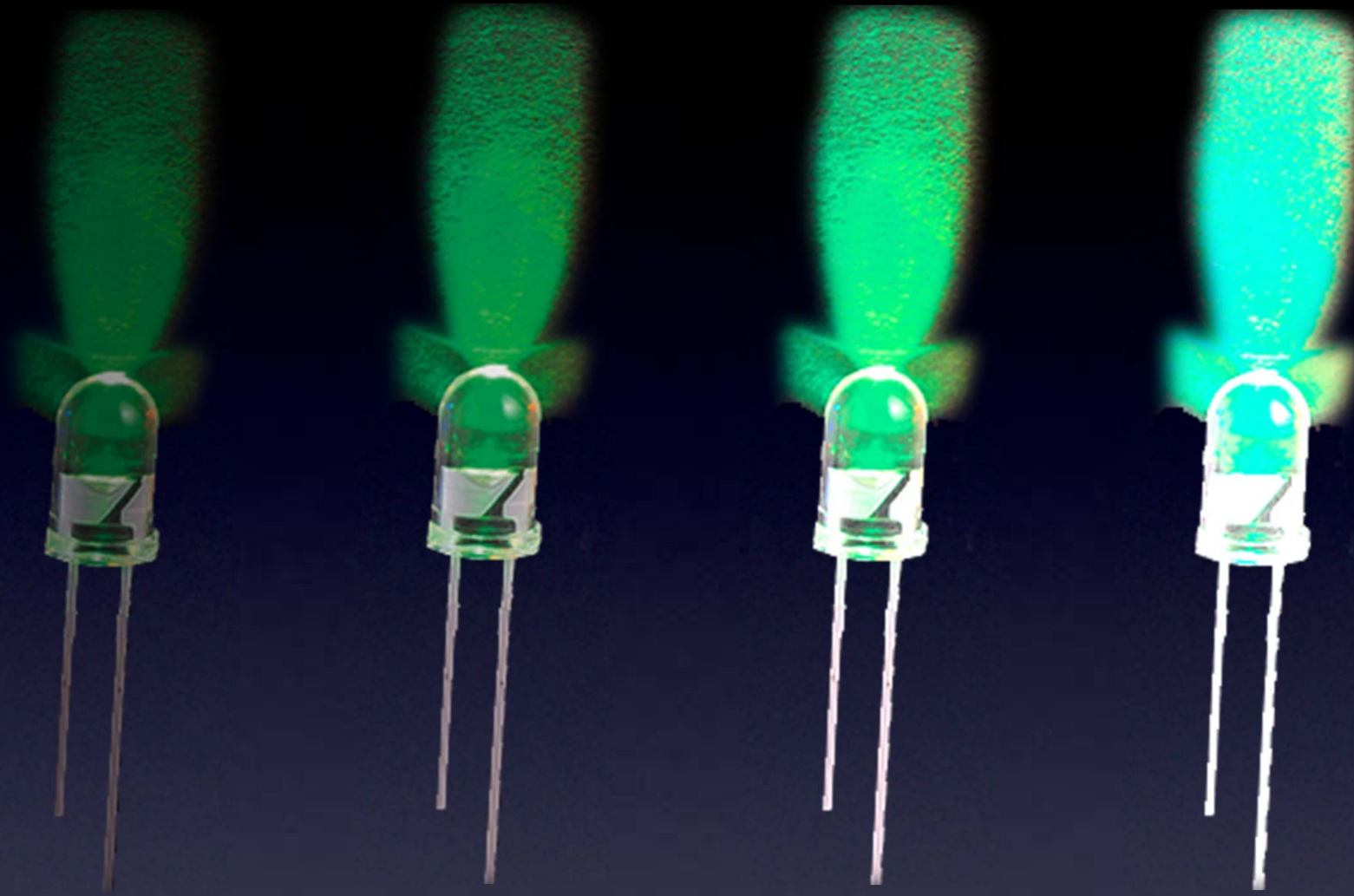

More current  $\rightarrow$  More brightness! (until...)

LED



# Everything You Need to Know About Electronics



More current → More brightness! (until...)

LED

# Everything You Need to Know About Electronics

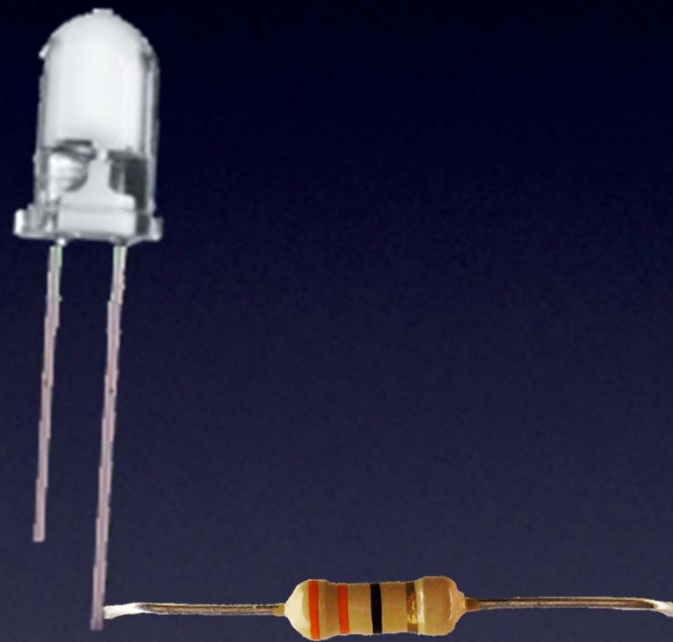

*(with a resistor  
so no magic smoke goes away)*

This is why we put a resistor in line with an LED

LED

# Everything You Need to Know About Electronics

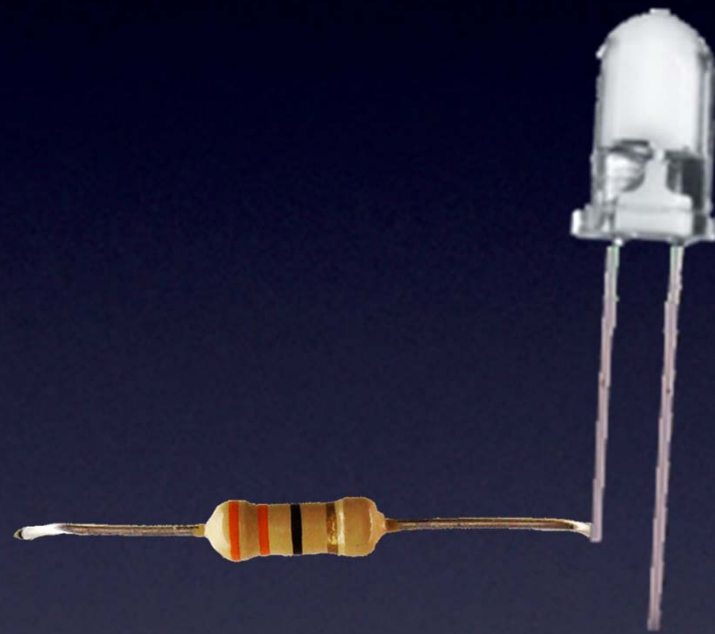

*(the resistor can go on either side)*

This is why we put a resistor in line with an LED

LED

# Everything You Need to Know About Electronics



Series = in line

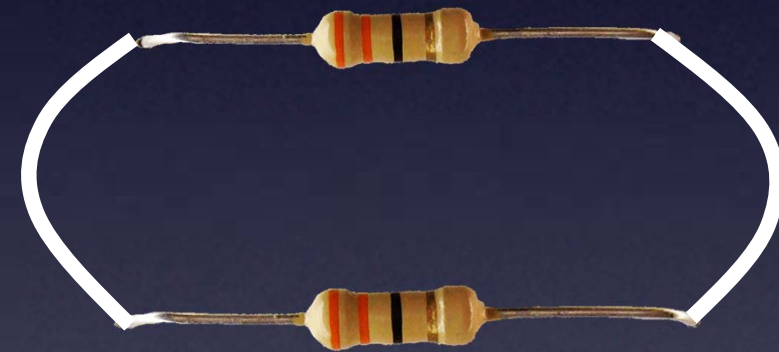

Parallel = across

# Everything You Need to Know About Electronics

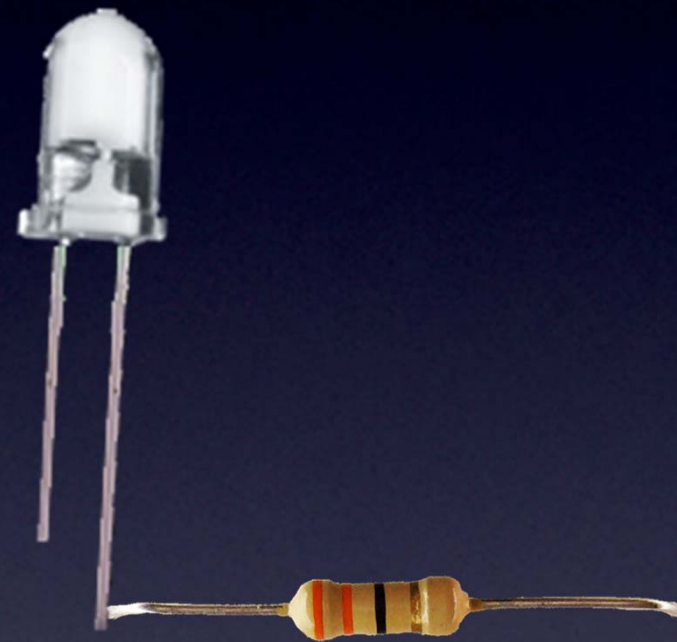

Let's make this light up!

LED

# Everything You Need to Know About Electronics

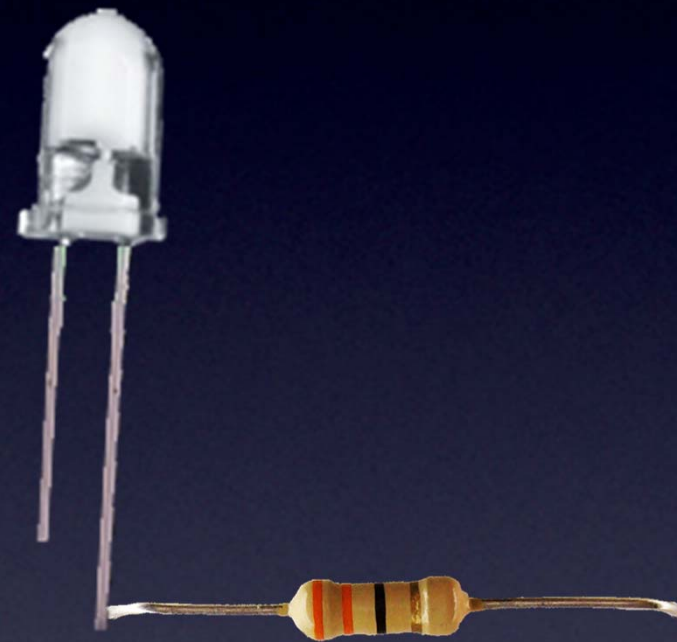
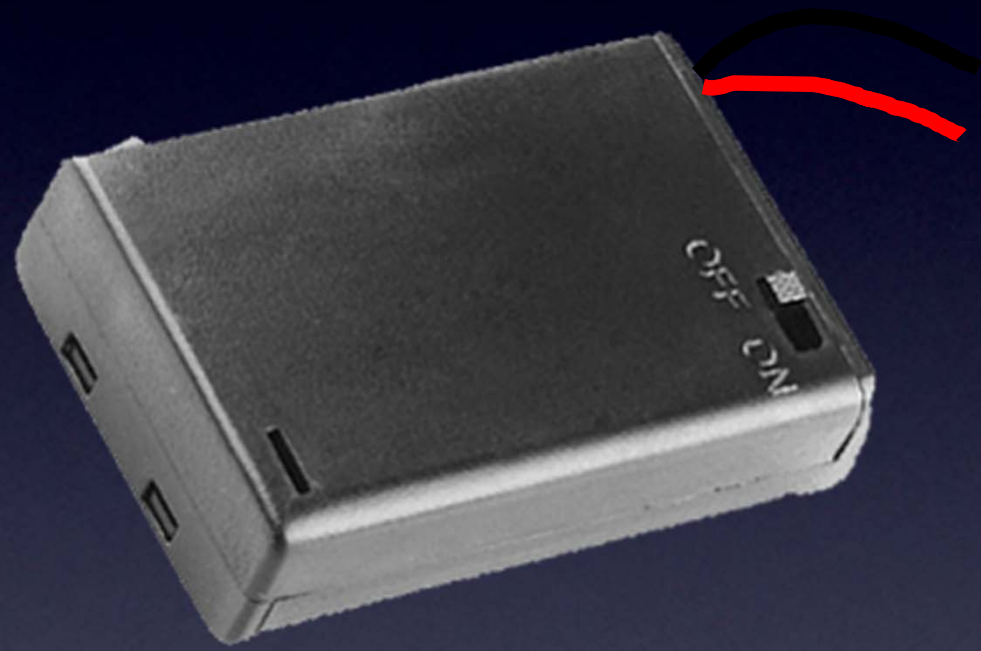

*(add a power supply)*

## Let's make this light up!

LED

# Everything You Need to Know About Electronics

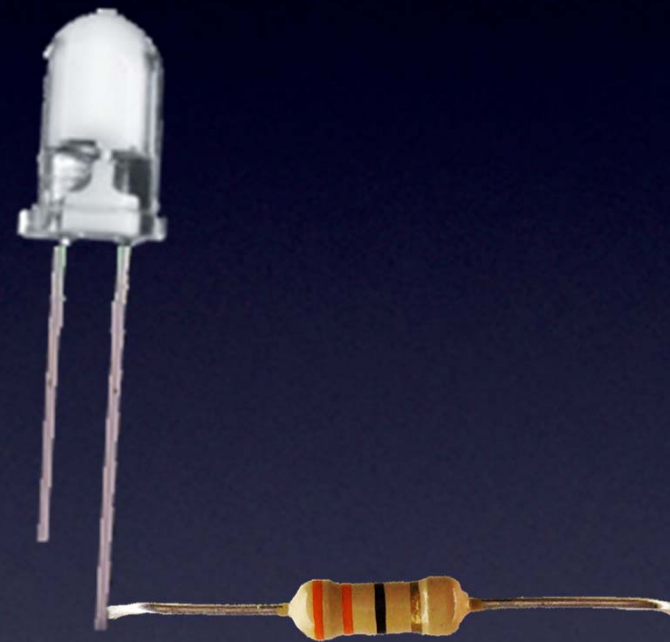
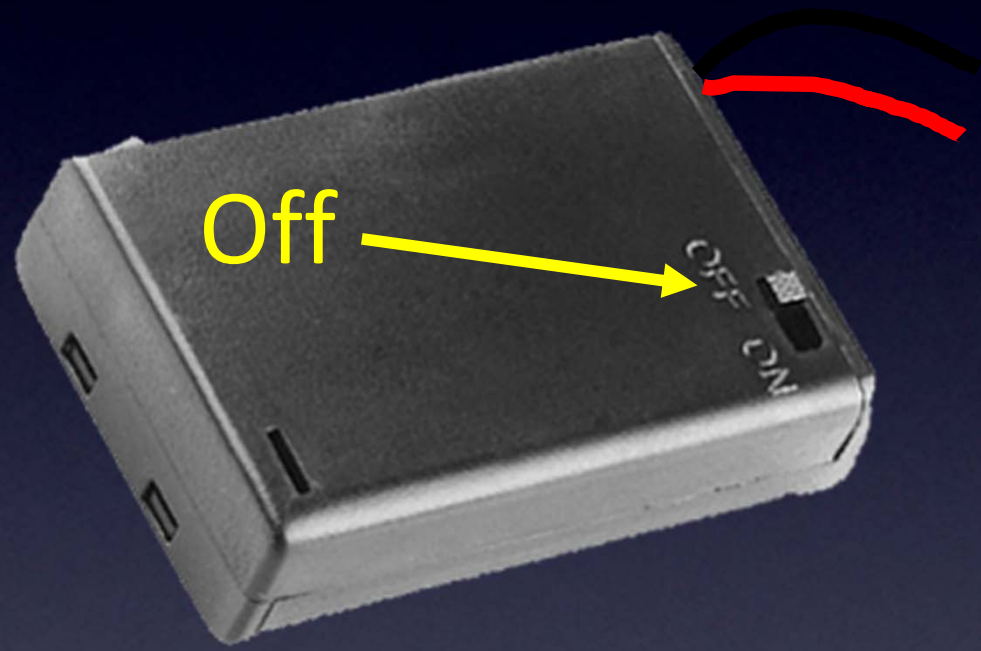

Let's make this light up!

LED

# Everything You Need to Know About Electronics

Black wire: “-” (ground)



Red wire: “+” power)

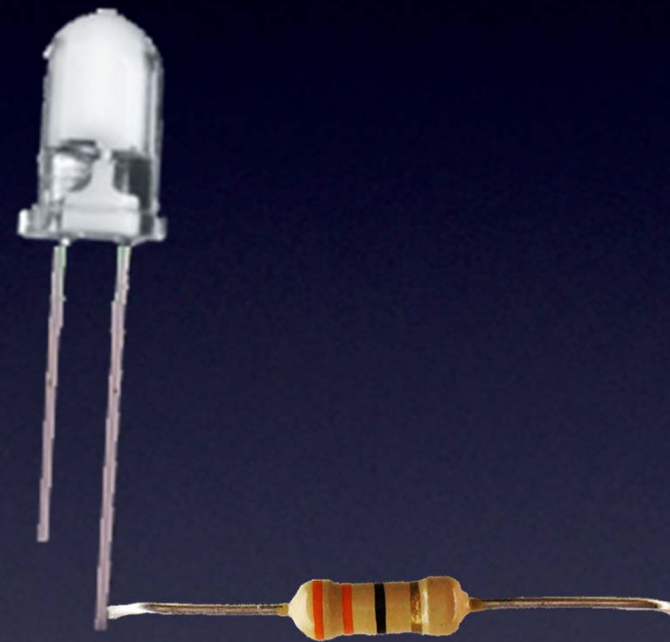

## Let's make this light up!

LED



# Everything You Need to Know About Electronics

short lead: “-”

Black wire: “-” (ground)

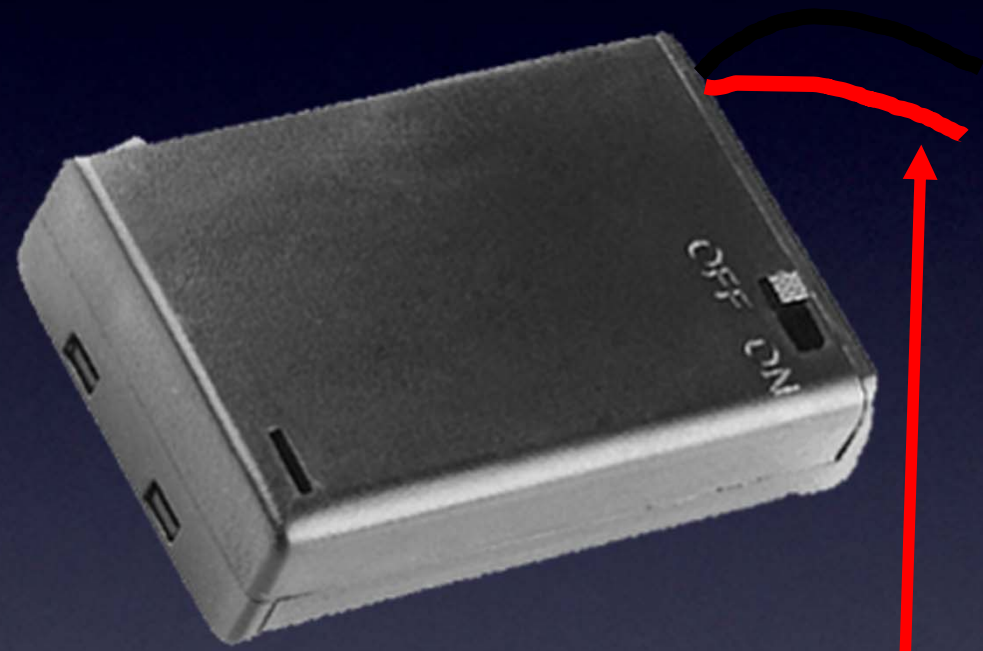

Red wire: “+” power)

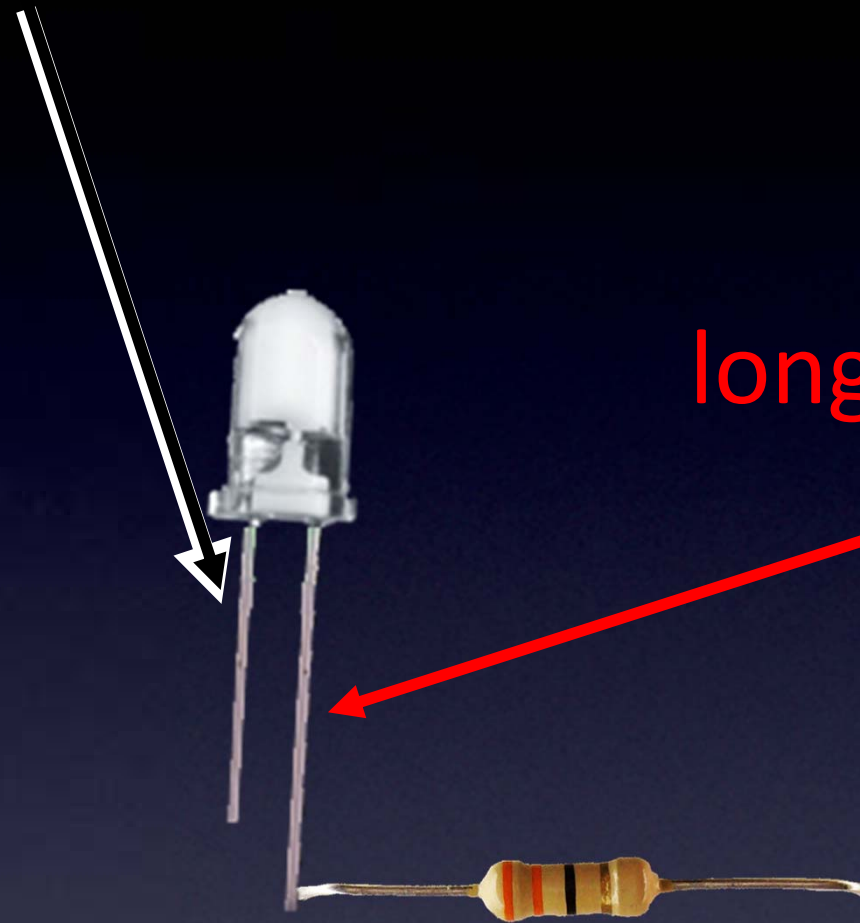

long lead: “+”

## Let's make this light up!

LED

# Everything You Need to Know About Electronics

short lead: “-”

Black wire: “-” (ground)

long lead: “+”

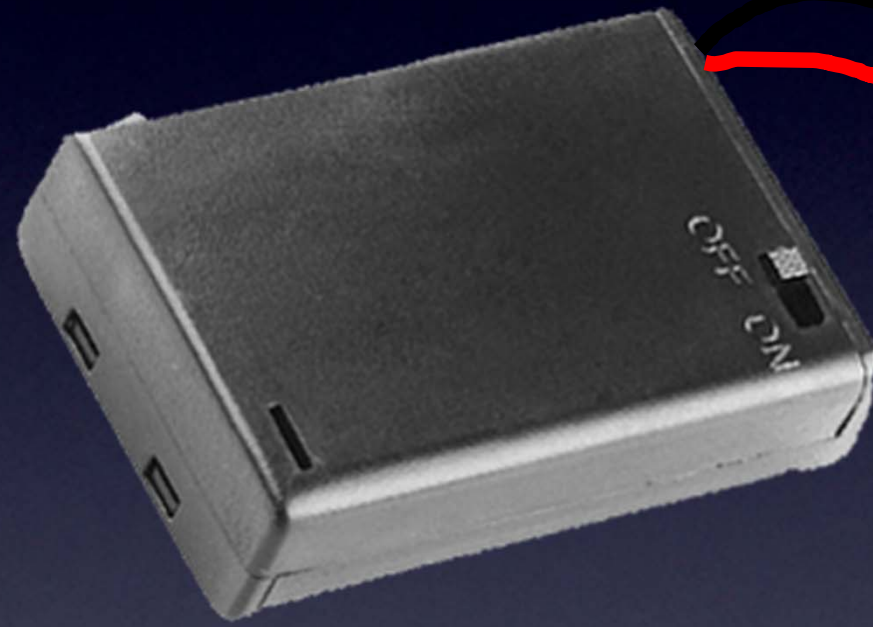

Red wire: “+” power)

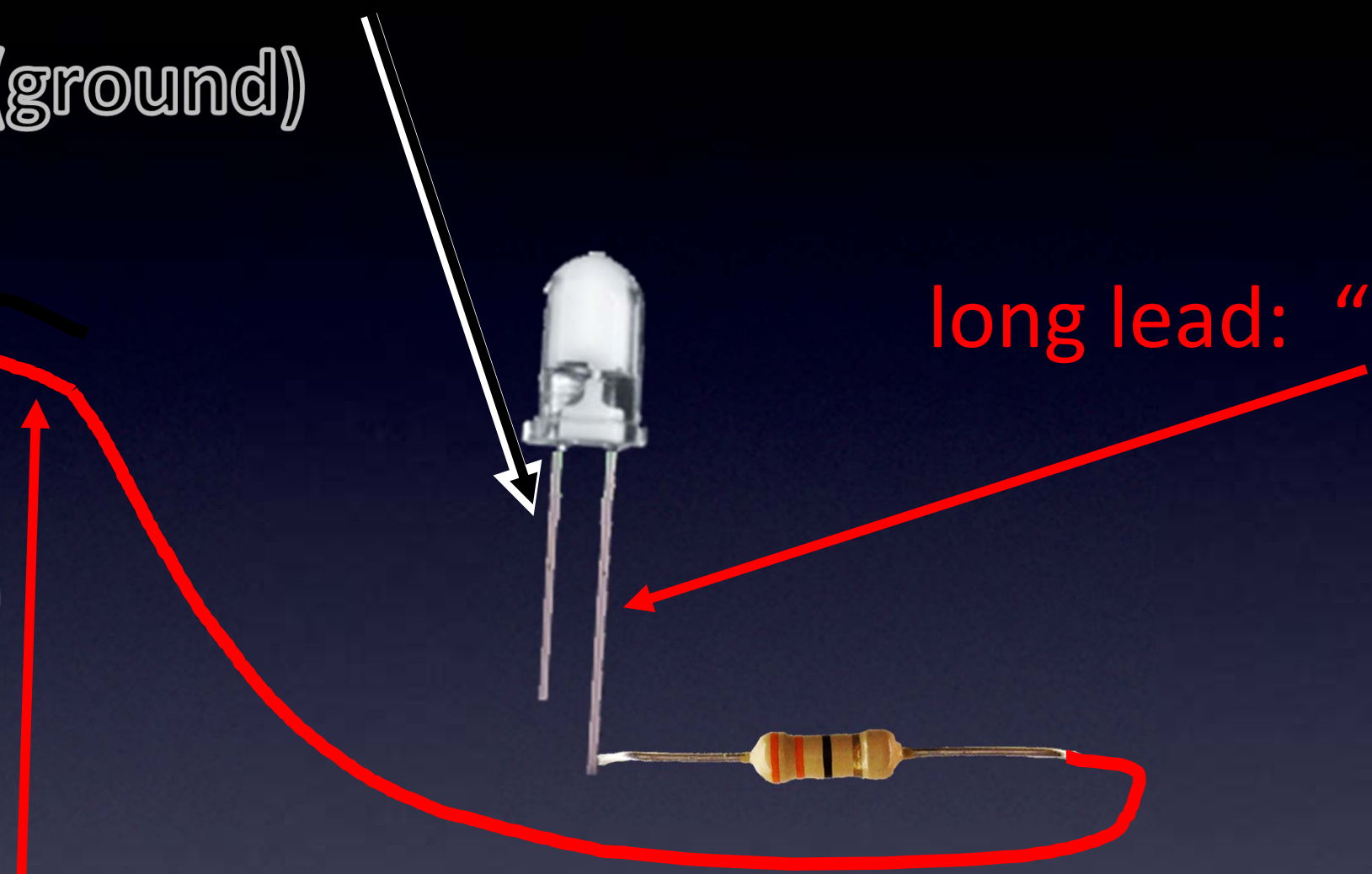

## Let's make this light up!

LED

# Everything You Need to Know About Electronics

short lead: “-”

Black wire: “-” (ground)

long lead: “+”

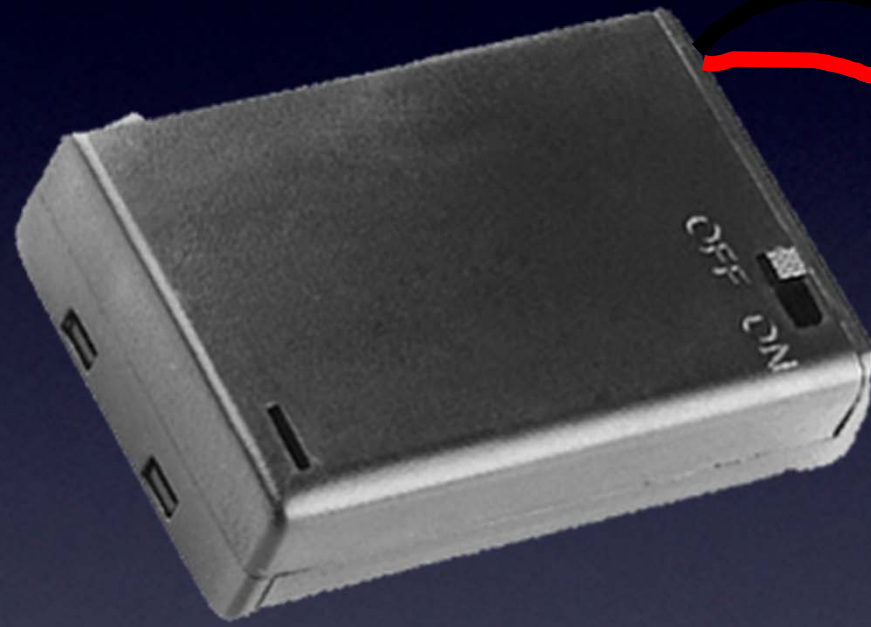

Red wire: “+” power)

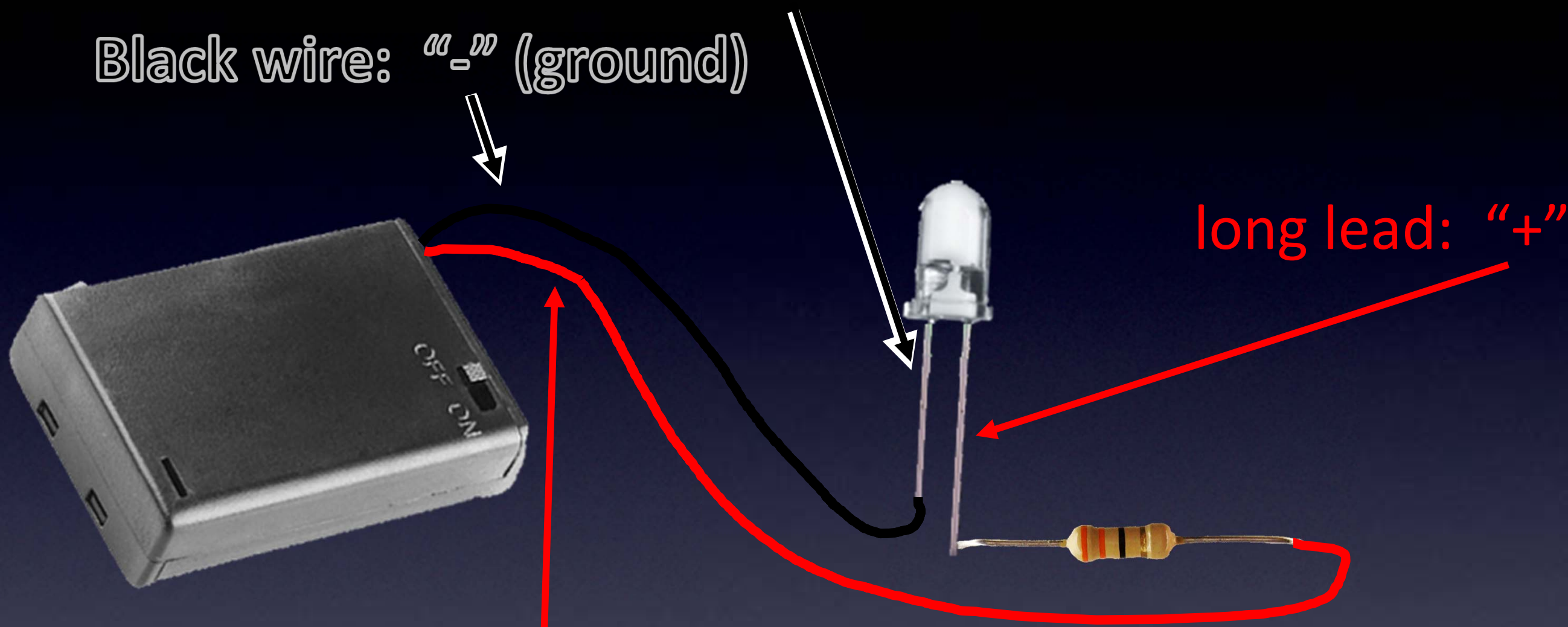

## Let's make this light up!

LED

# Everything You Need to Know About Electronics

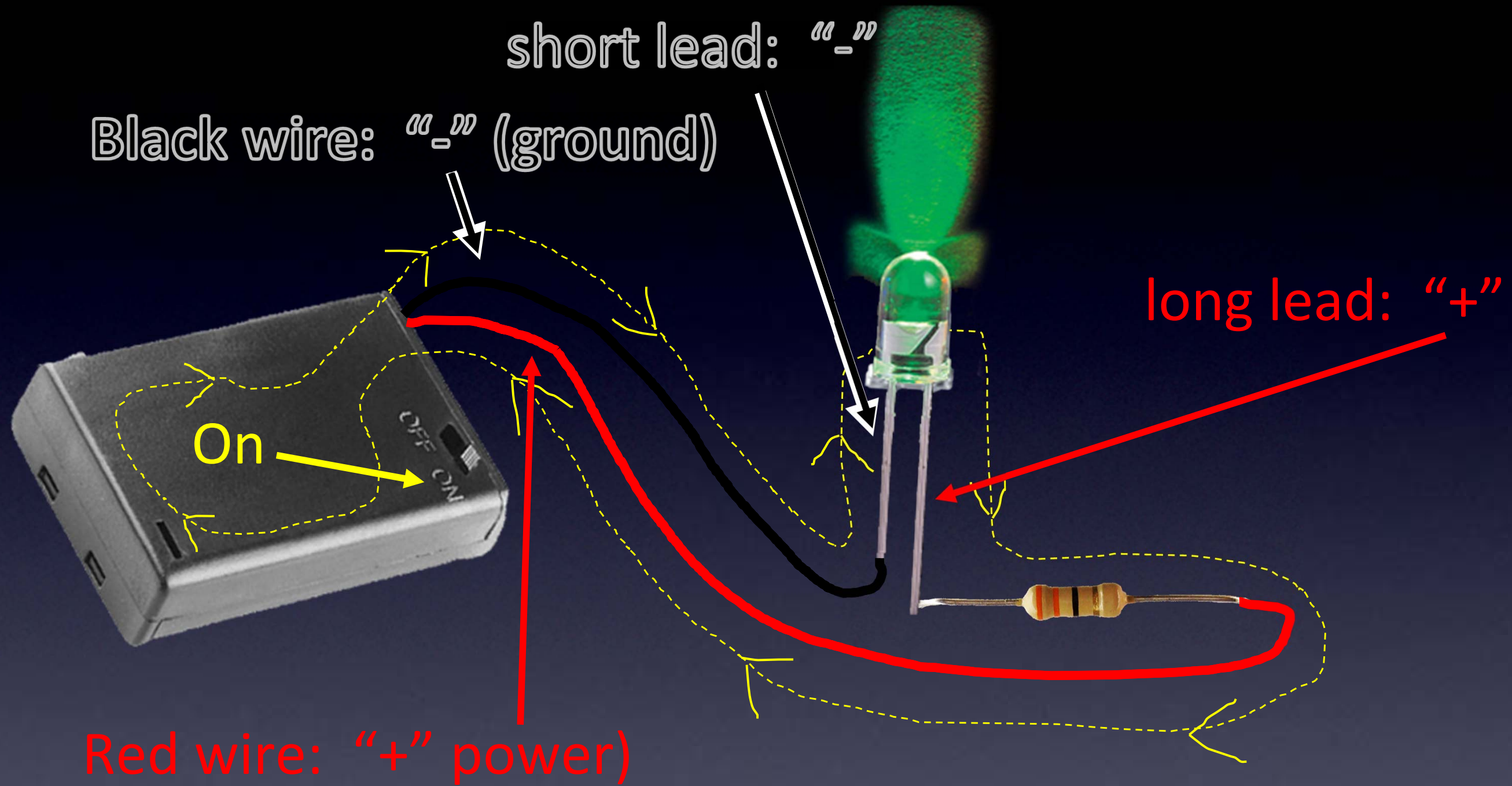

It lights!

LED

# Everything You Need to Know About Electronics

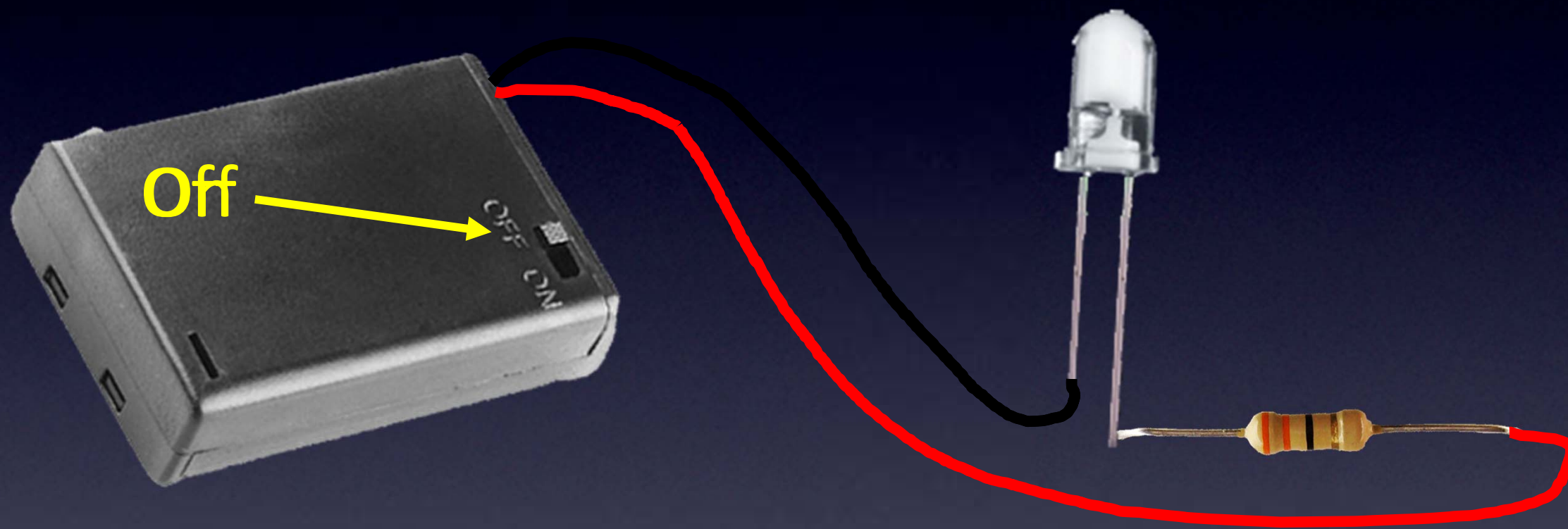

It's off

LED

# Everything You Need to Know About Electronics

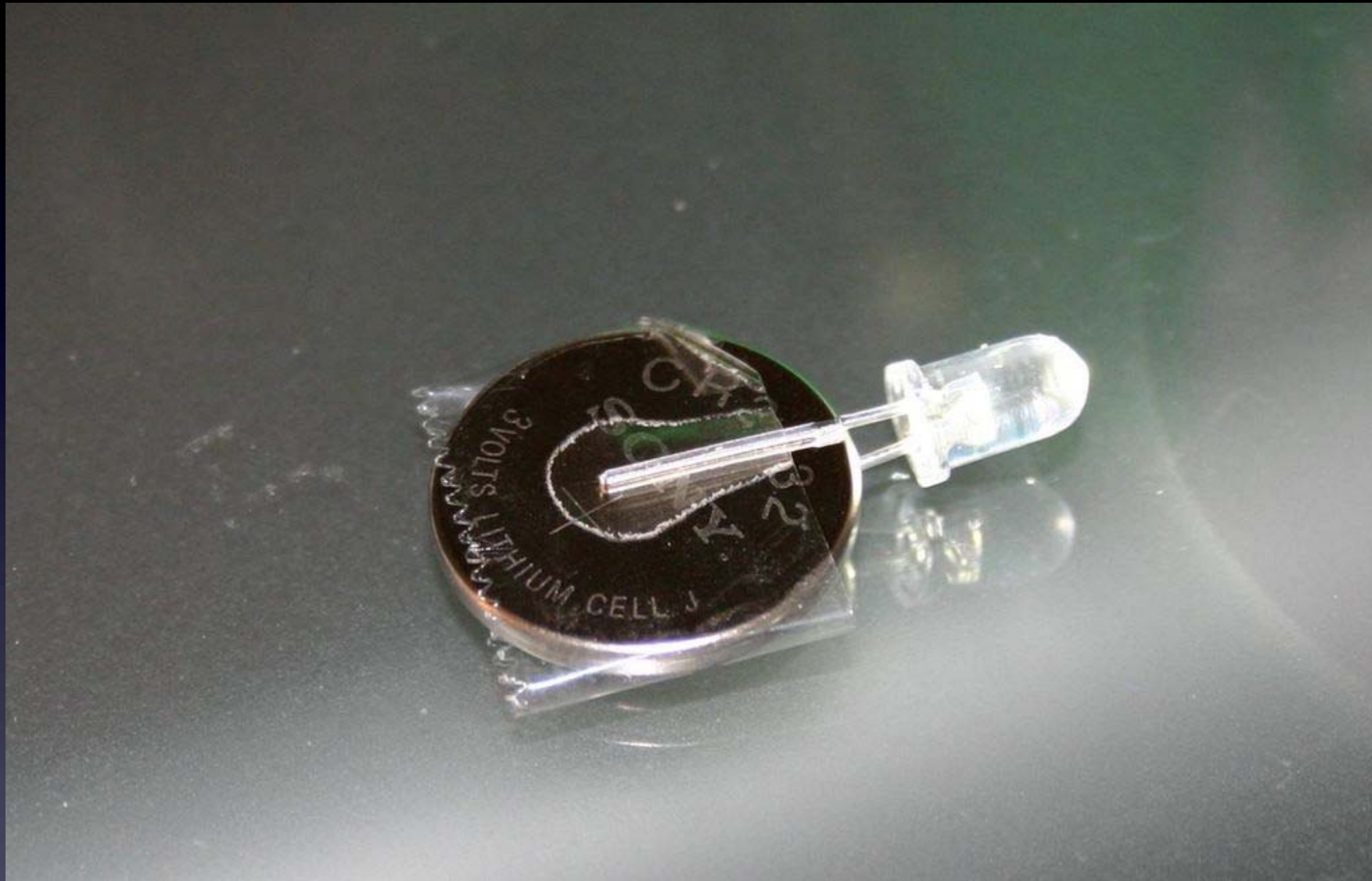

LED & battery

Our first circuit

# Everything You Need to Know About Electronics

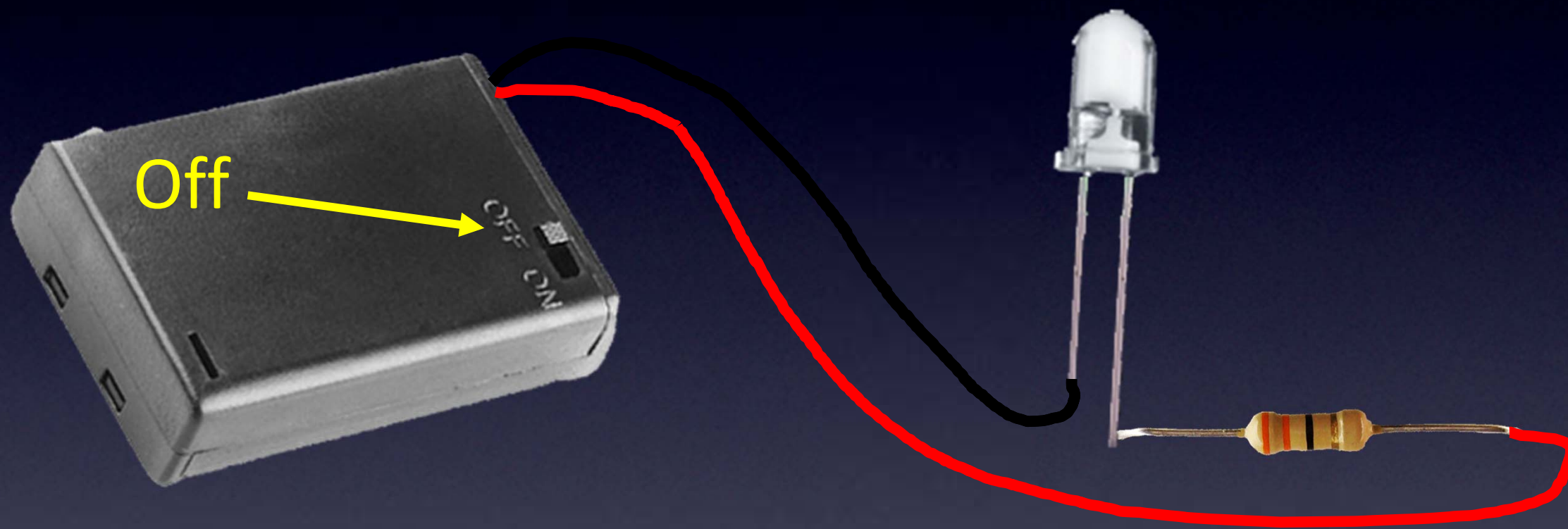

IR LED

# Everything You Need to Know About Electronics

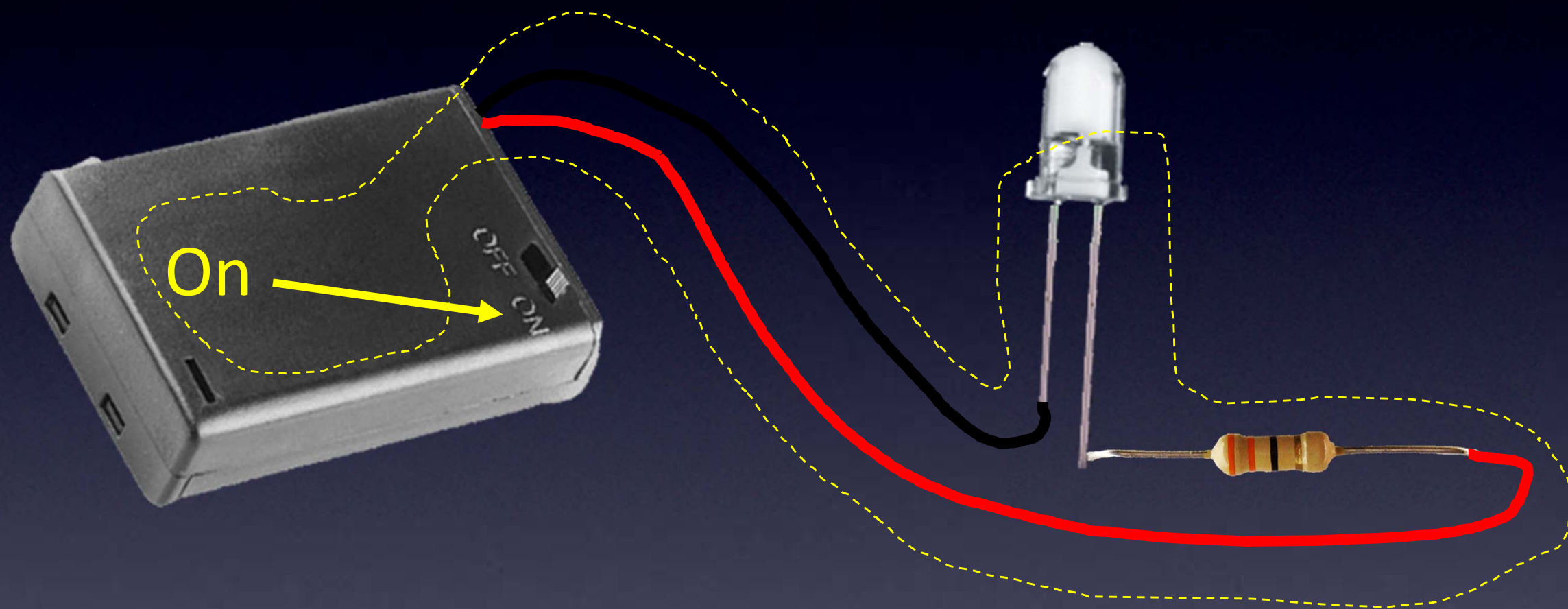

IR LED



# Everything You Need to Know About Electronics

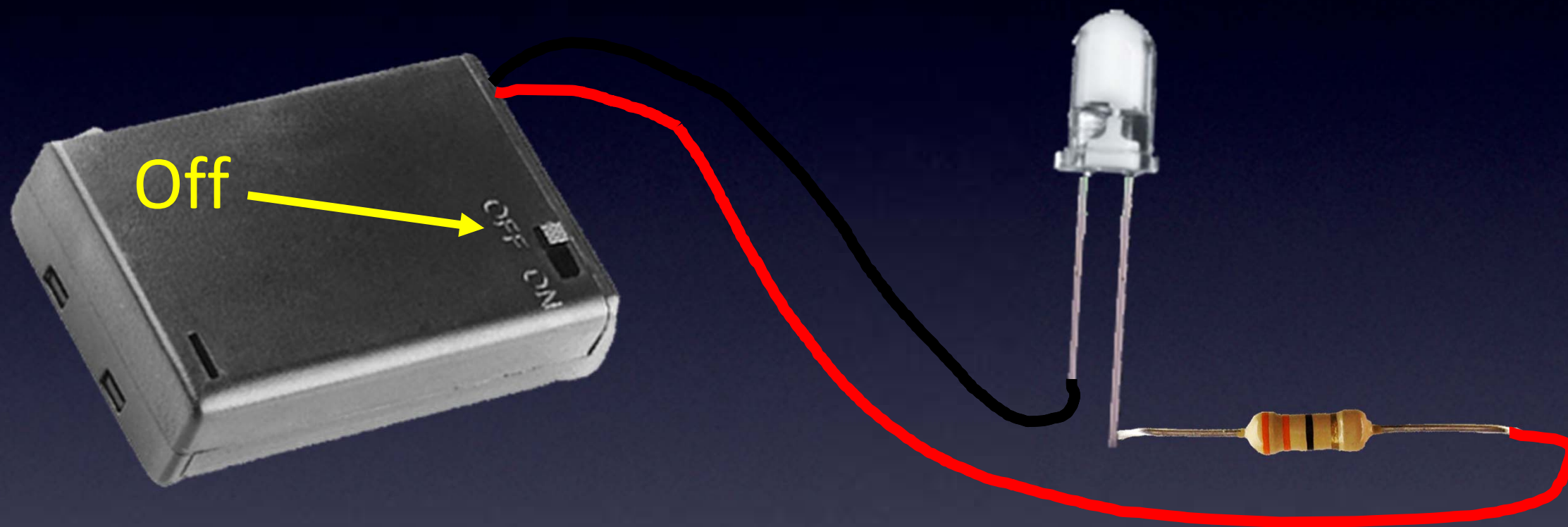

IR LED

# Everything You Need to Know About Electronics

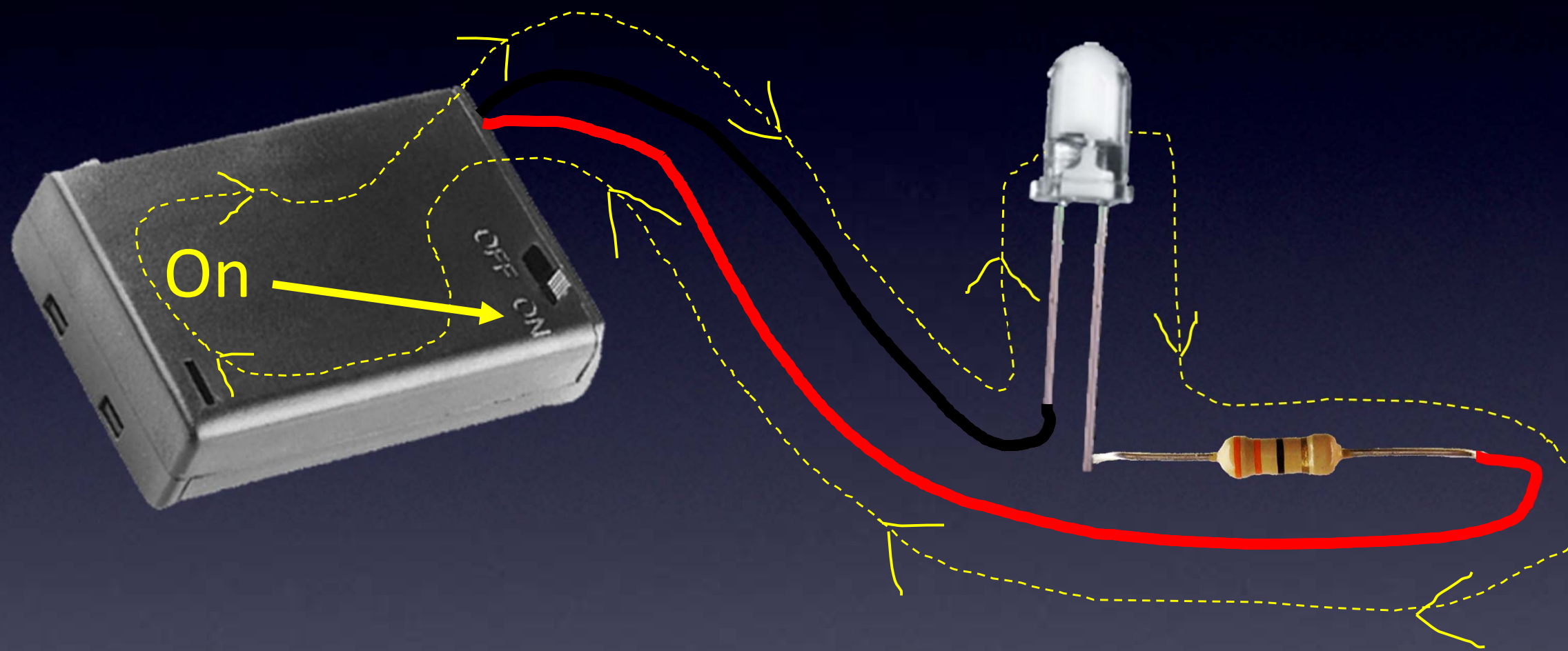

IR LED

# Everything You Need to Know About Electronics

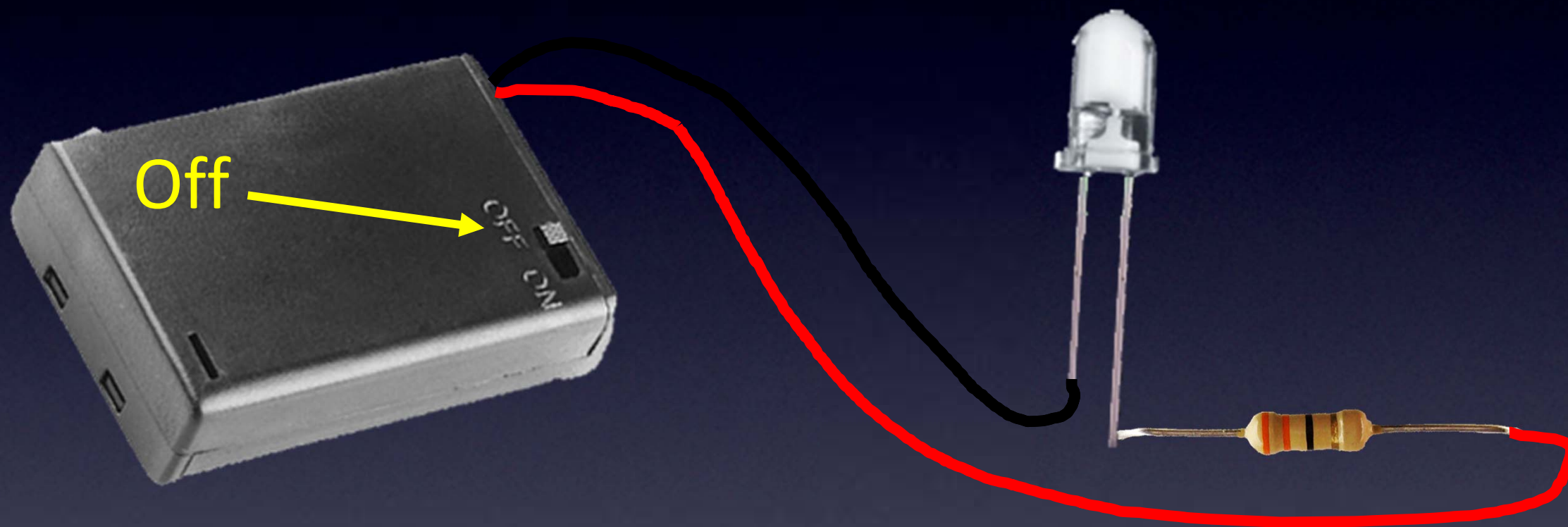

A “code” is IR light blinking on-off-on-off...

IR Remote Control

# Everything You Need to Know About Electronics

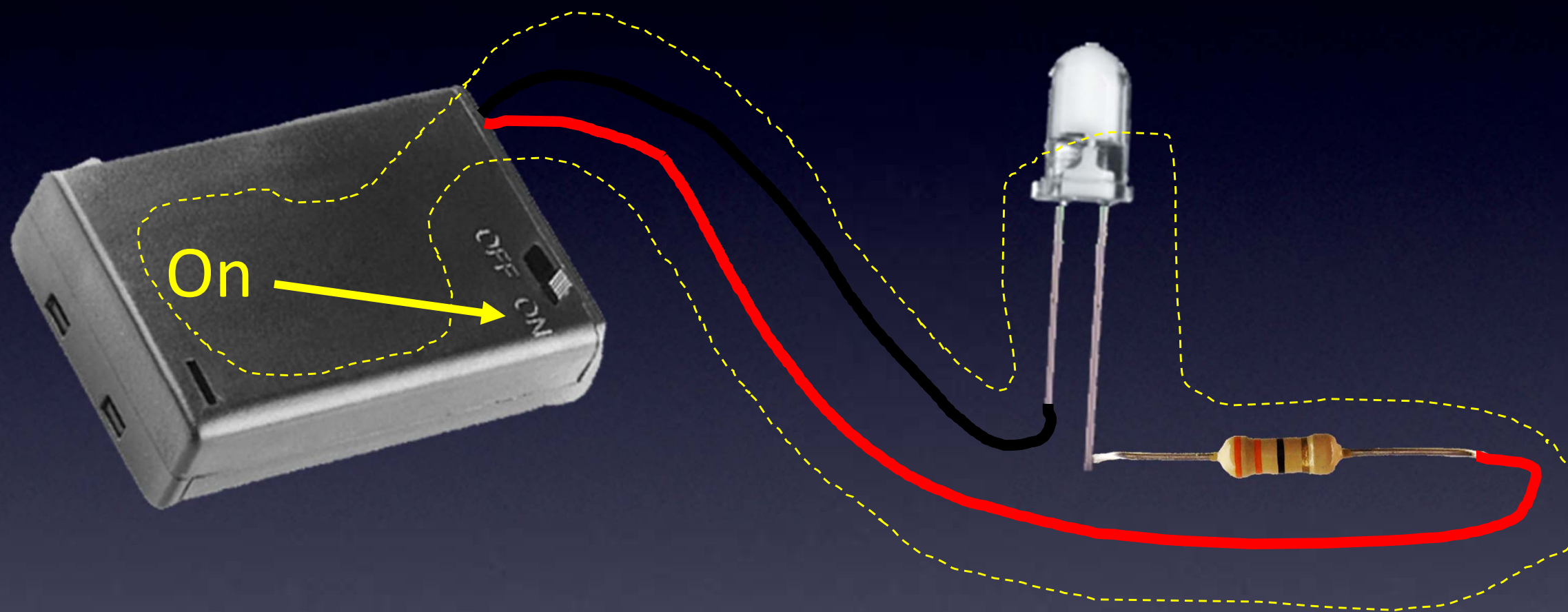

A “code” is IR light blinking on-off-on-off...

*(we can't do this, but microcontrollers can!)*

## IR Remote Control

# Everything You Need to Know About Electronics

Takes about 60 seconds

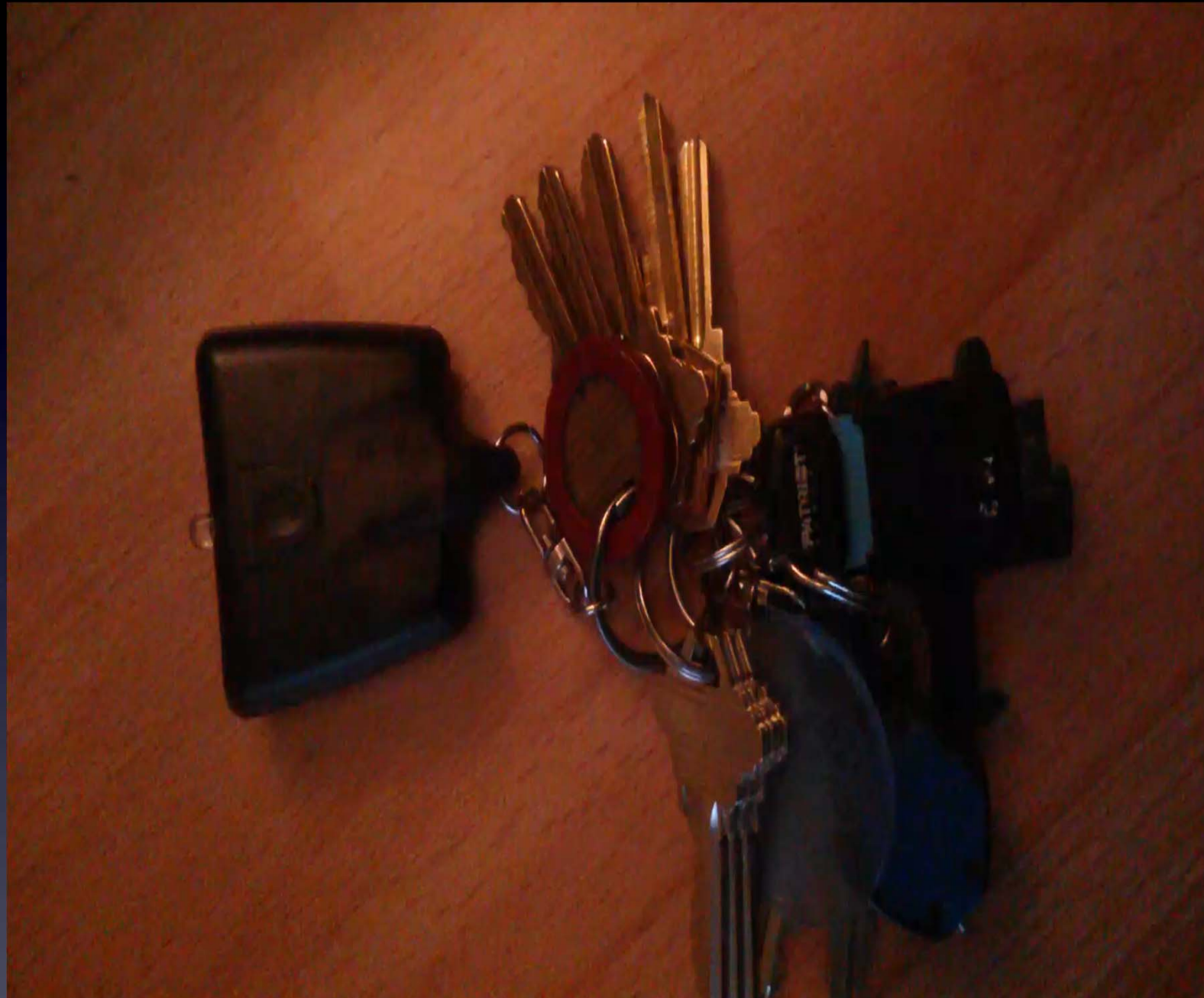

About 150 IR "OFF" codes (one per blink)

TV-B-Gone universal remote control

# Everything You Need to Know About Electronics

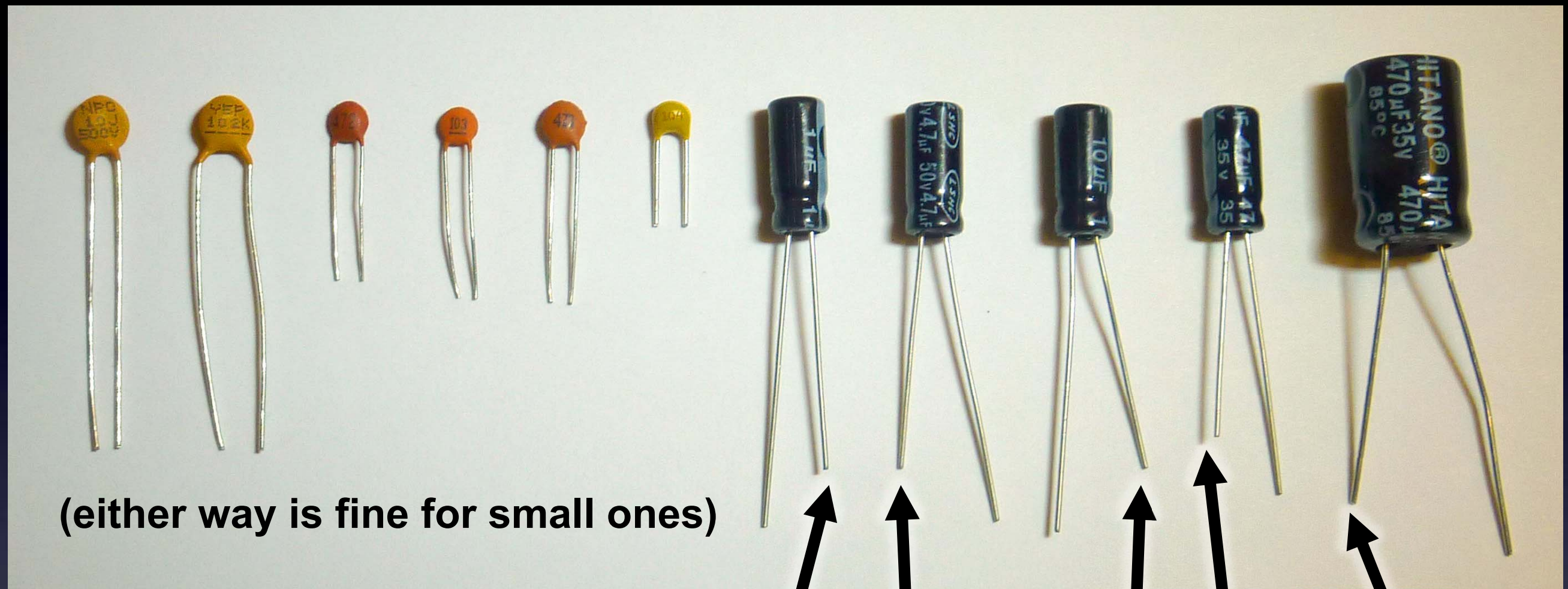

(either way is fine for small ones)

**Short wire is Minus / Negative**

Little buckets for electrons

Capacitor / Farads

# Everything You Need to Know About Electronics

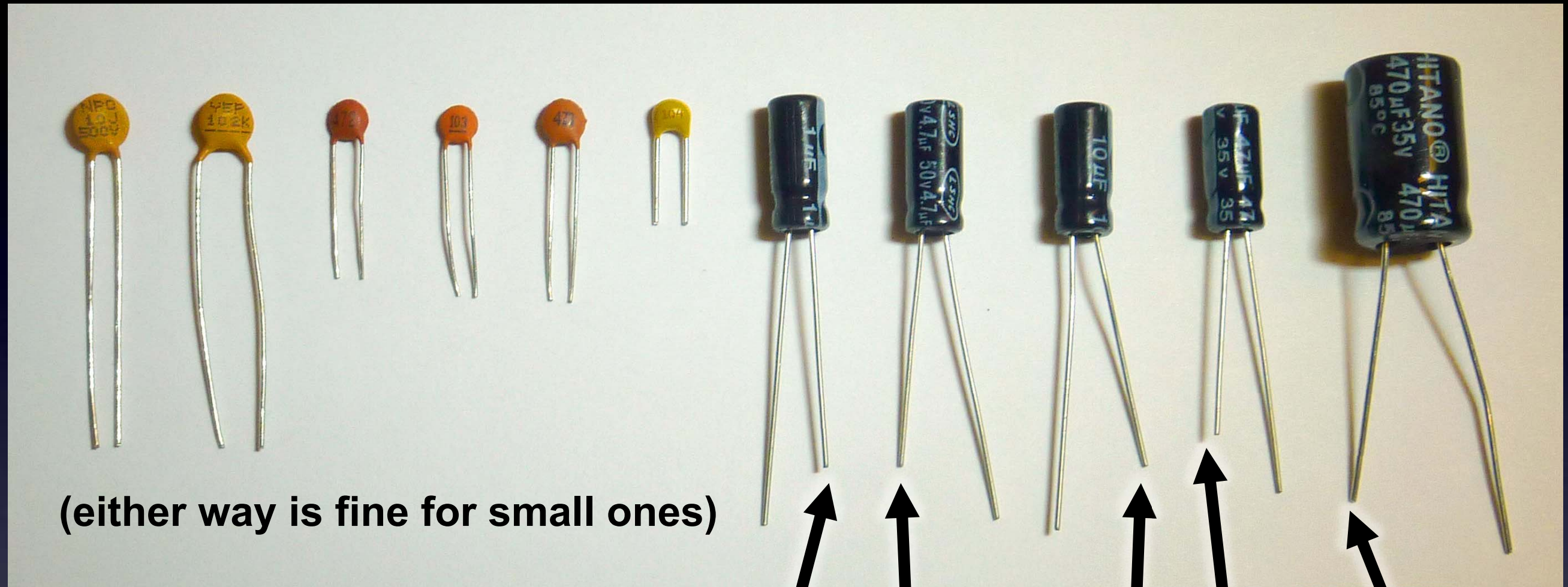

(either way is fine for small ones)

Short wire is Minus / Negative

Little buckets for electrons

Capacitor / Farads

# Everything You Need to Know About Electronics

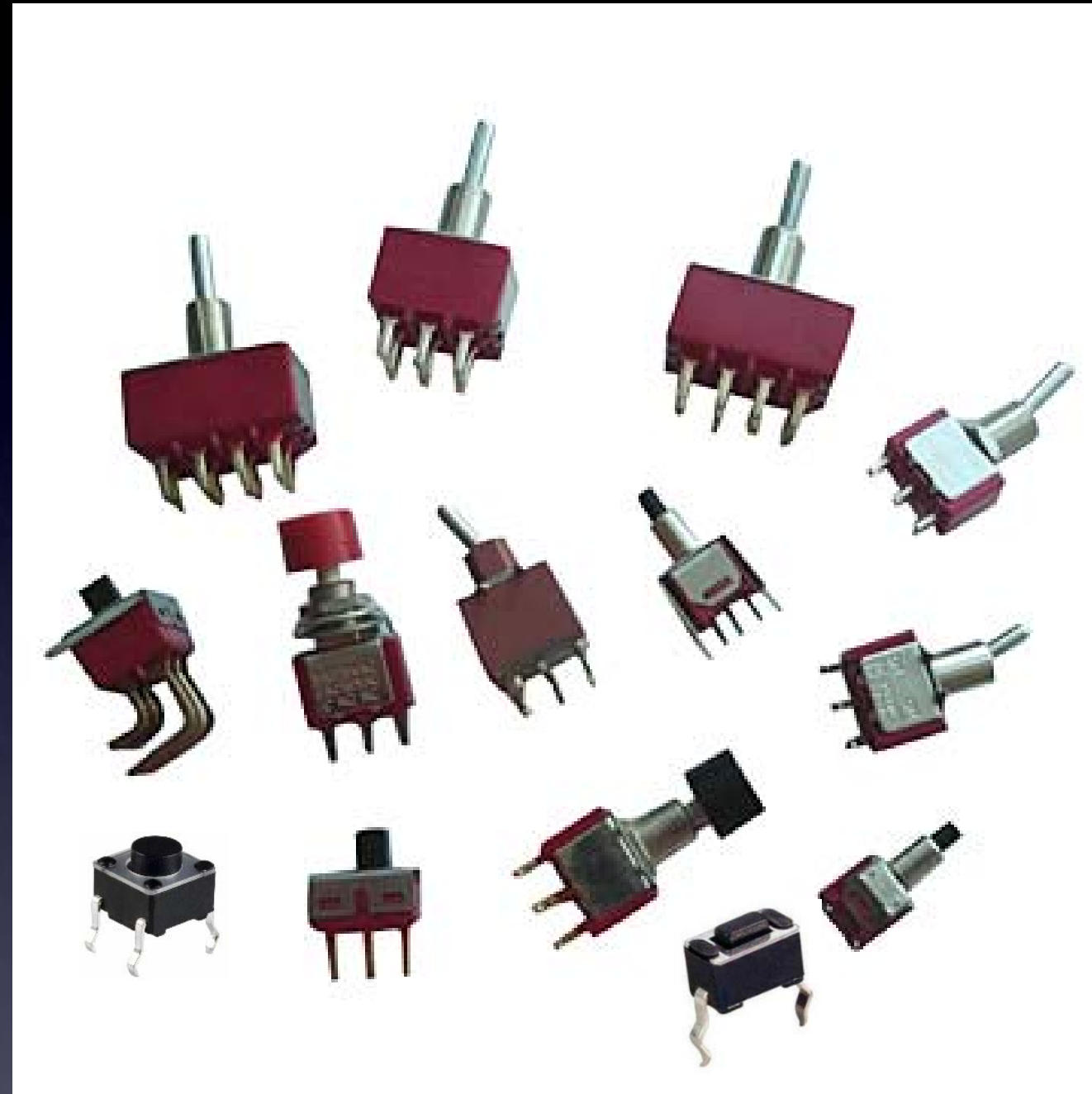

Strips of metal connected together – or not

Switch



# Everything You Need to Know About Electronics

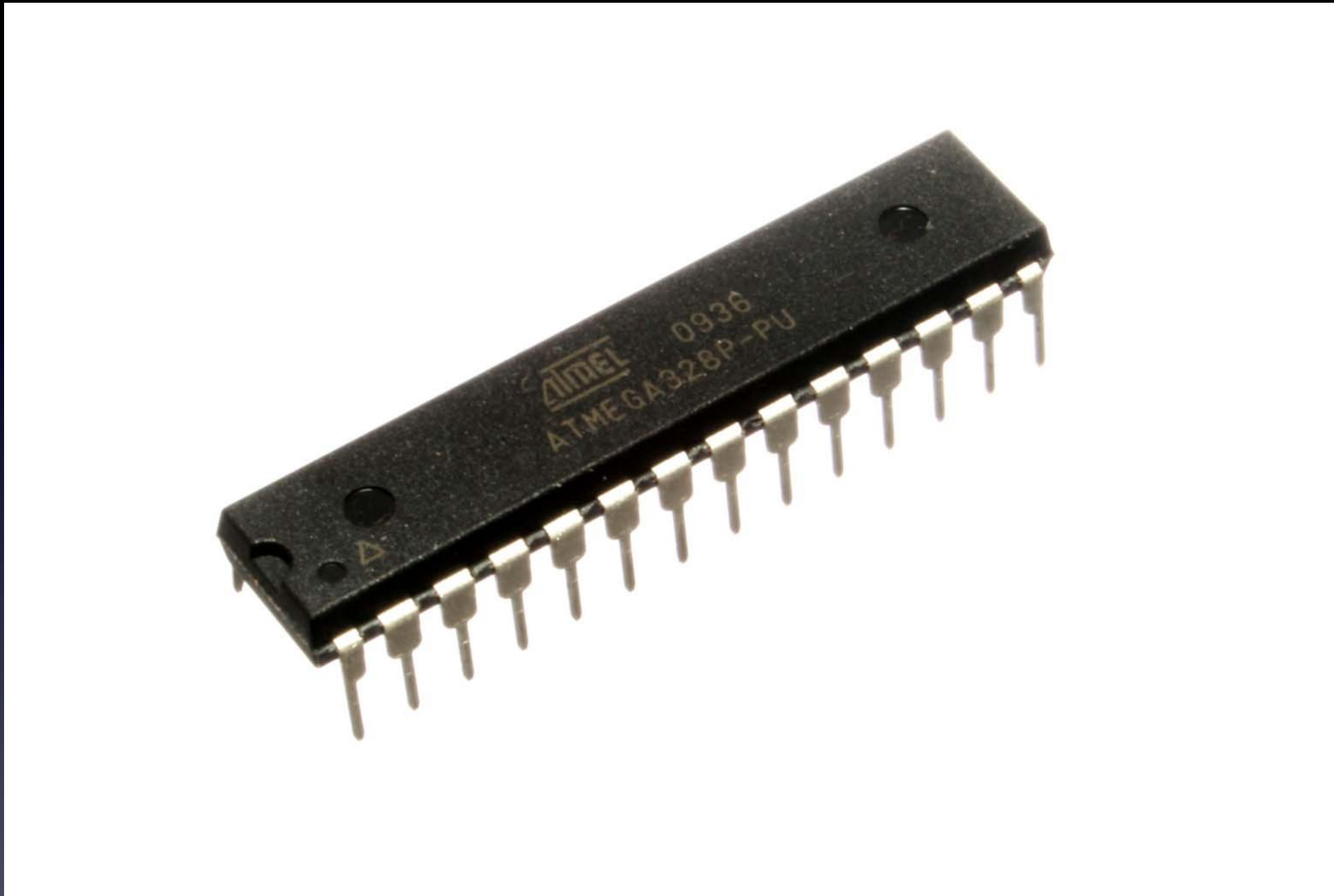

A complete computer on a chip

Microcontroller

# Everything You Need to Know About Electronics



that control electronic parts connected to its pins.

Microcontroller

# Everything You Need to Know About Electronics

2 special pins:

Pin 1

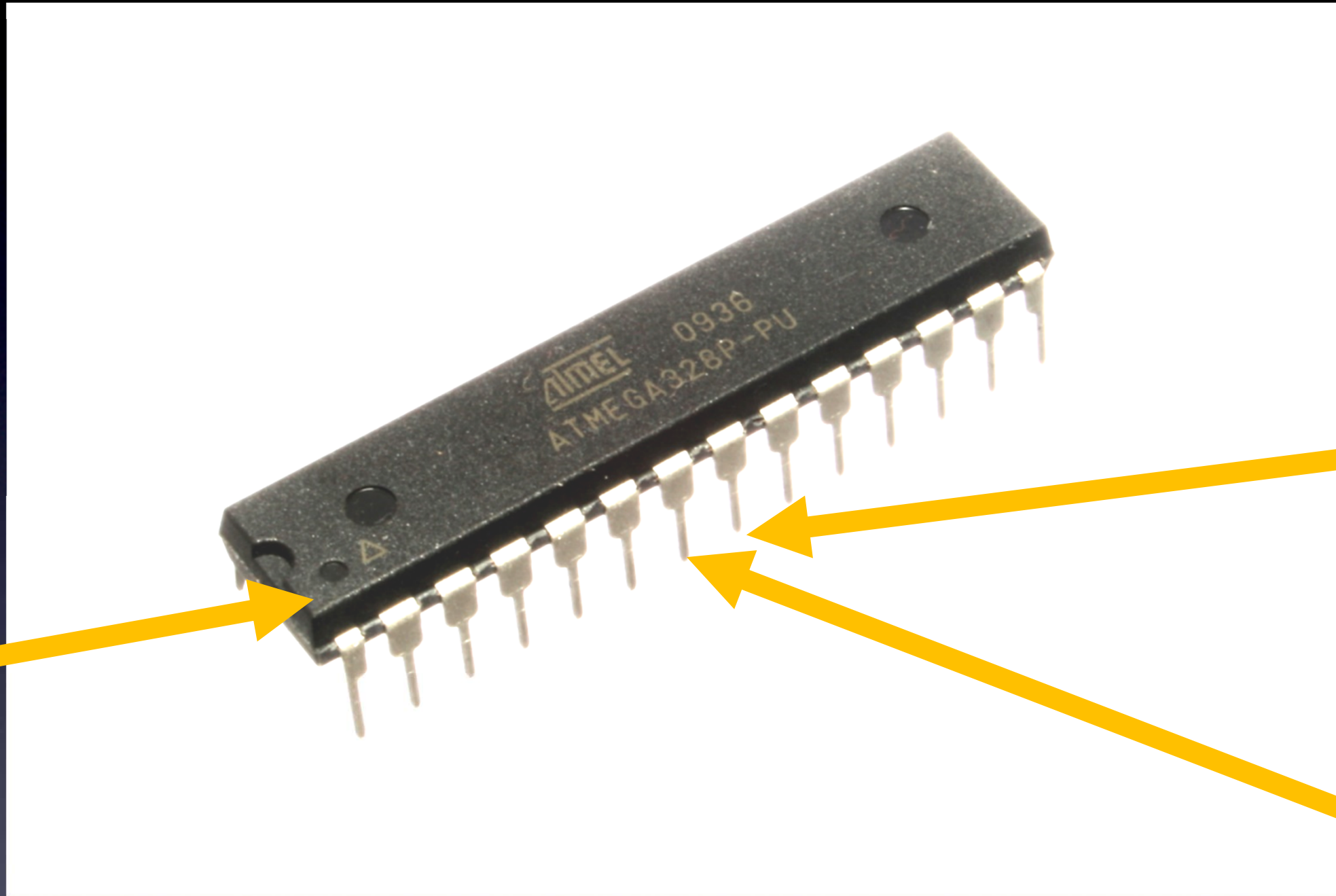

Pin 8 =  
Ground

Pin 7 =  
Vcc

A complete computer on a chip

Microcontroller – it matters how you hook it up!

# Everything You Need to Know About Electronics

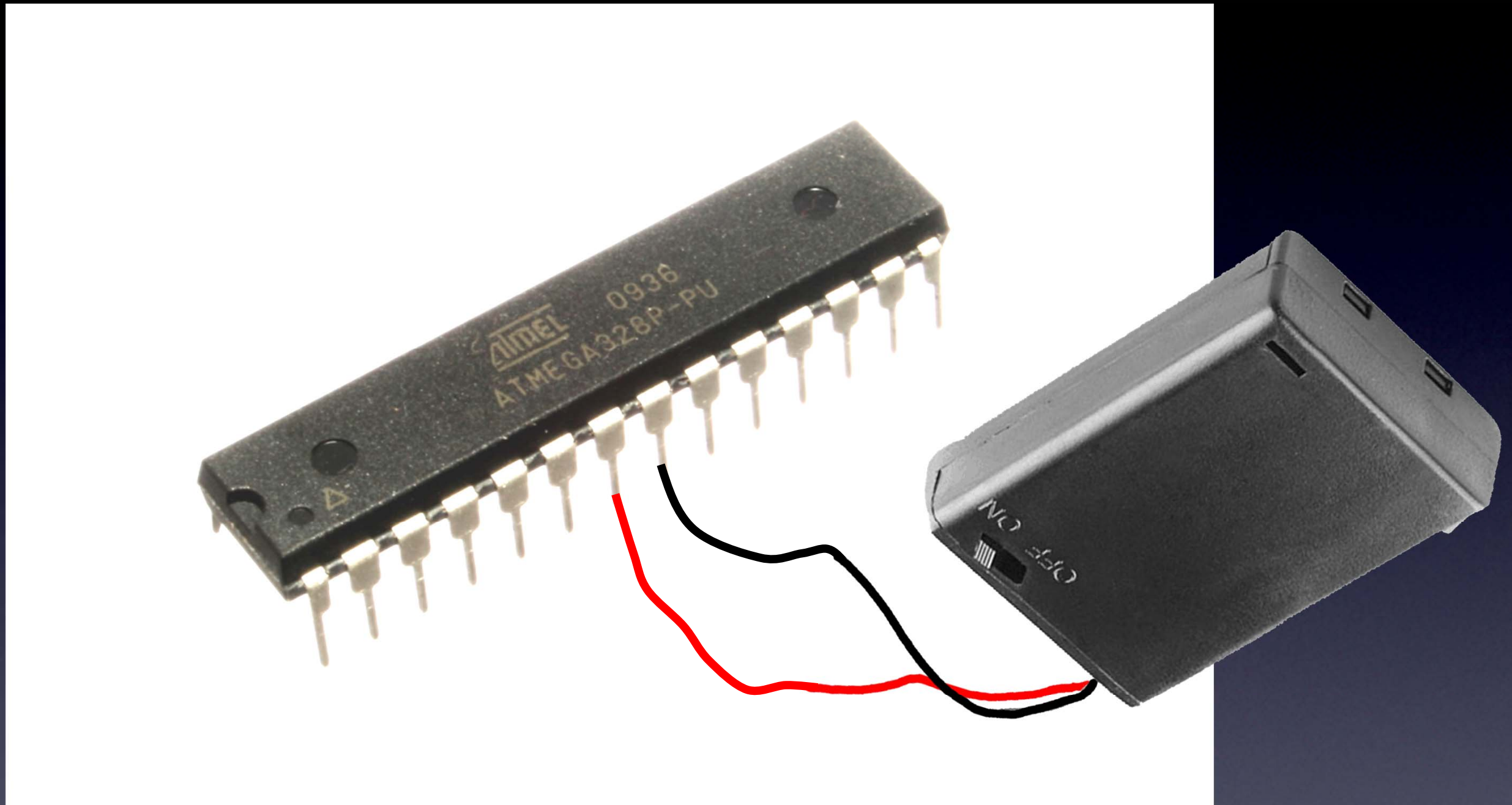

A complete computer – running a program!

Microcontroller – turned on!

# Everything You Need to Know About Electronics

**all other pins are  
Input pins  
or  
Output pins**

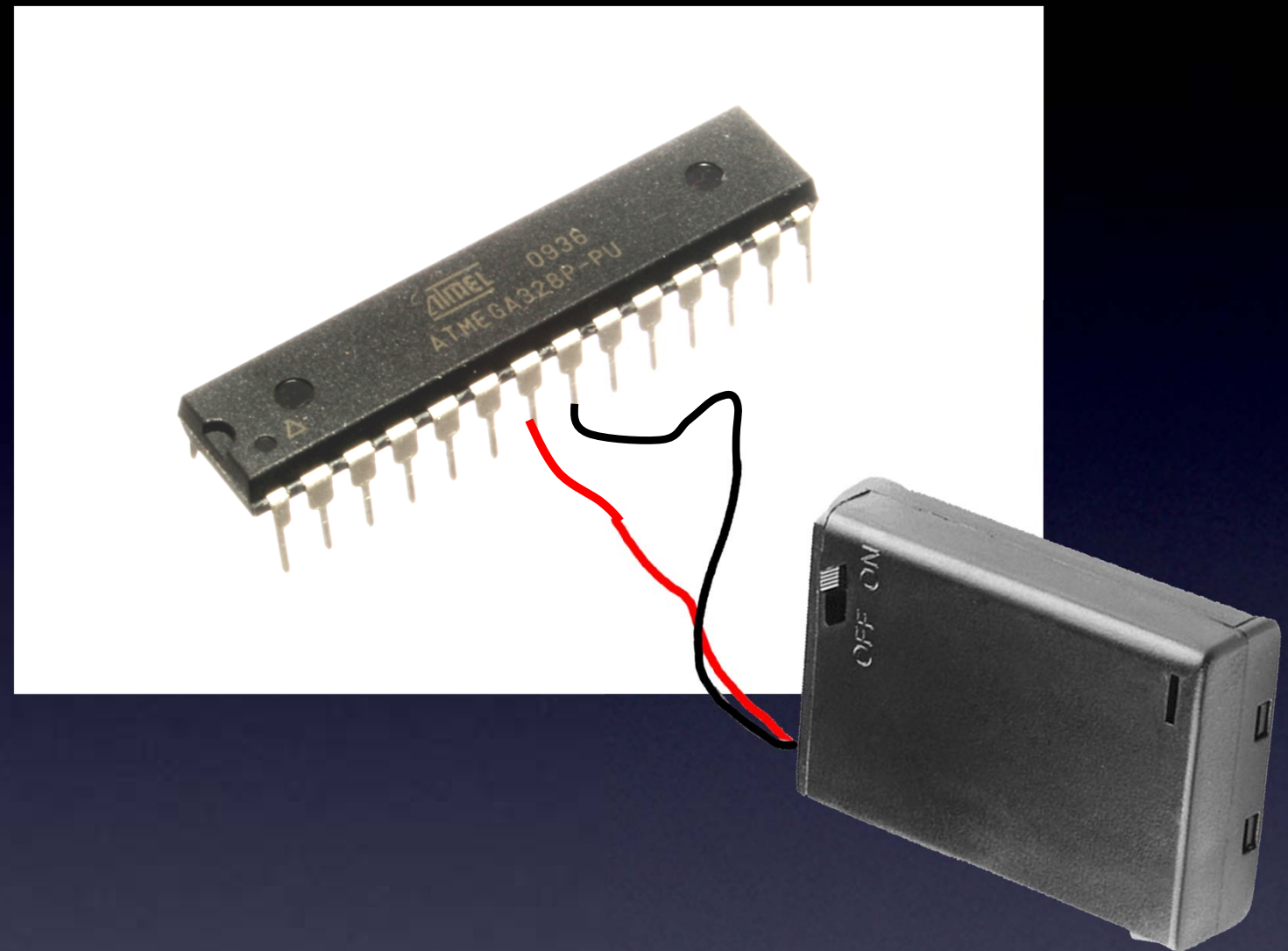

**Your program controls electronics parts  
on these other pins**

**Microcontroller**

# Everything You Need to Know About Electronics

## **Analog Electronics:**

Any voltage between Ground (0V) and Vcc

## **Digital Electronics:**

Only 2 choices: Ground (0V) or Vcc

2 types of electronics

# Everything You Need to Know About Electronics

Ground (0V)

**Low**

**Off**

**0**

Power / Vcc

**High**

**On**

**1**

(without Voltage / with Voltage)

(without current / with current)

**Digital Electronics:**

Only 2 choices: Ground (0V) or Vcc

Digital Electronics

# Everything You Need to Know About Electronics

To make a pin an  
**Output pin**

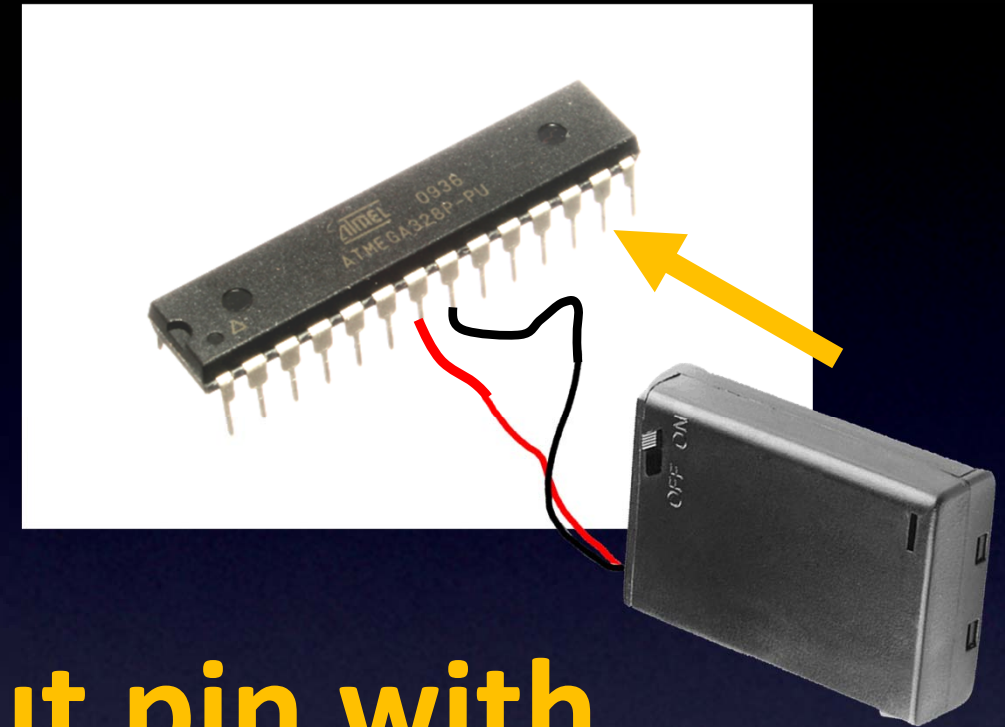

you tell it to become an **Output pin** with  
a statement in your program

Let's tell pin 13 to be an **Output pin**

Microcontroller – Output pins



# Everything You Need to Know About Electronics

**Low**

**Off**

**(0V)**

**High**

**On**

**(Power supply voltage)**

**-- like the Red wire of our power supply**

***-- but controlled by our program!***

**Only 2 choices: High or Low**

**Microcontroller – Output pins**

Everything You Need to Know About Electronics

**A real world example**

**How to make an LED blink?**

Hello World

Microcontroller

# Everything You Need to Know About Electronics

## Software

**Type:**

Hello World  
**on your screen**

## Microcontrollers

**make an LED blink**

Hello World

Microcontroller

# Everything You Need to Know About Electronics

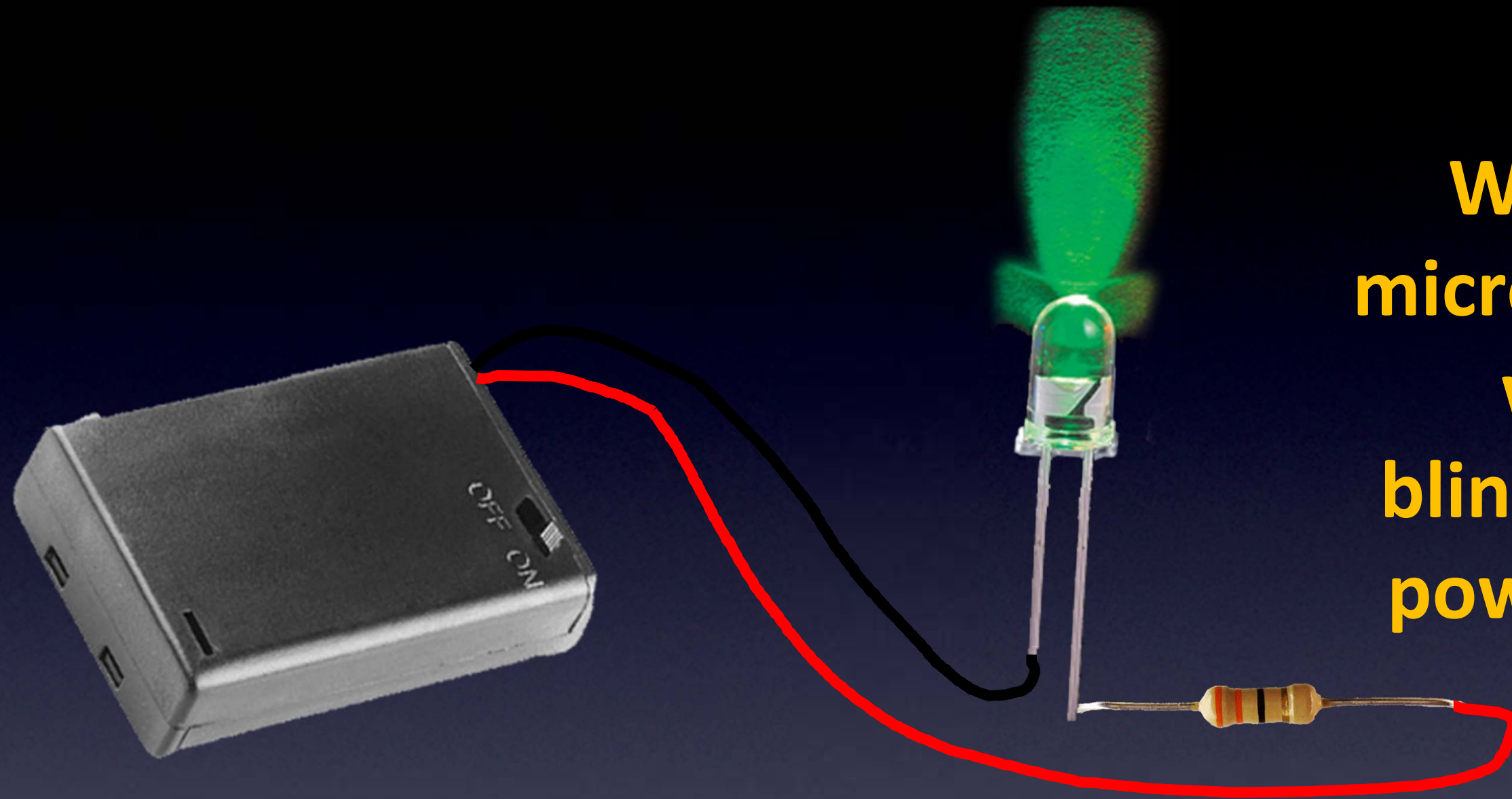

**Without a  
microcontroller  
we can  
blink with our  
power supply**

**Turning an LED on and off**

(Leading up to Hello World)

# Everything You Need to Know About Electronics

**Let's replace  
the power supply**

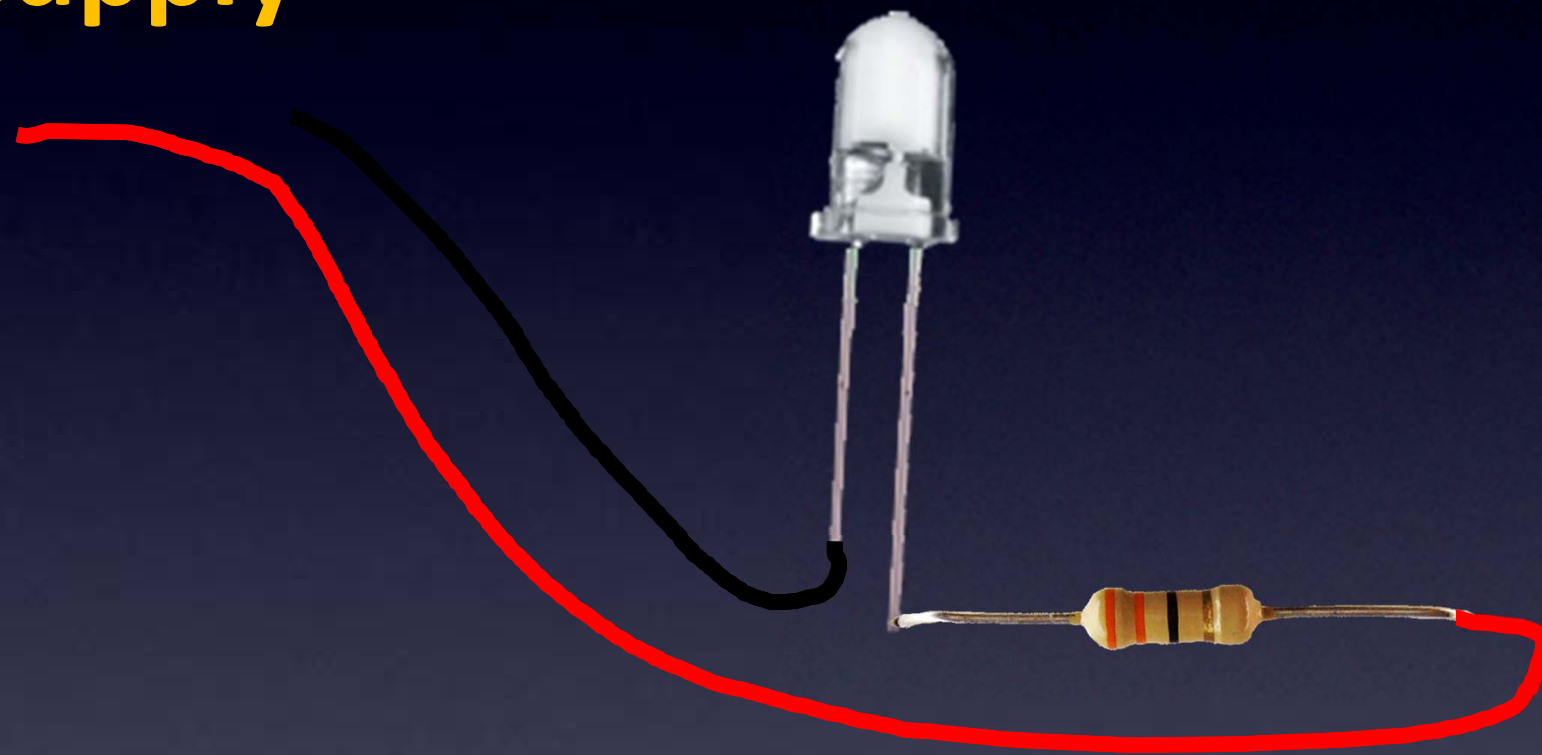

**Turning an LED on and off**

(Leading up to Hello World)

# Everything You Need to Know About Electronics

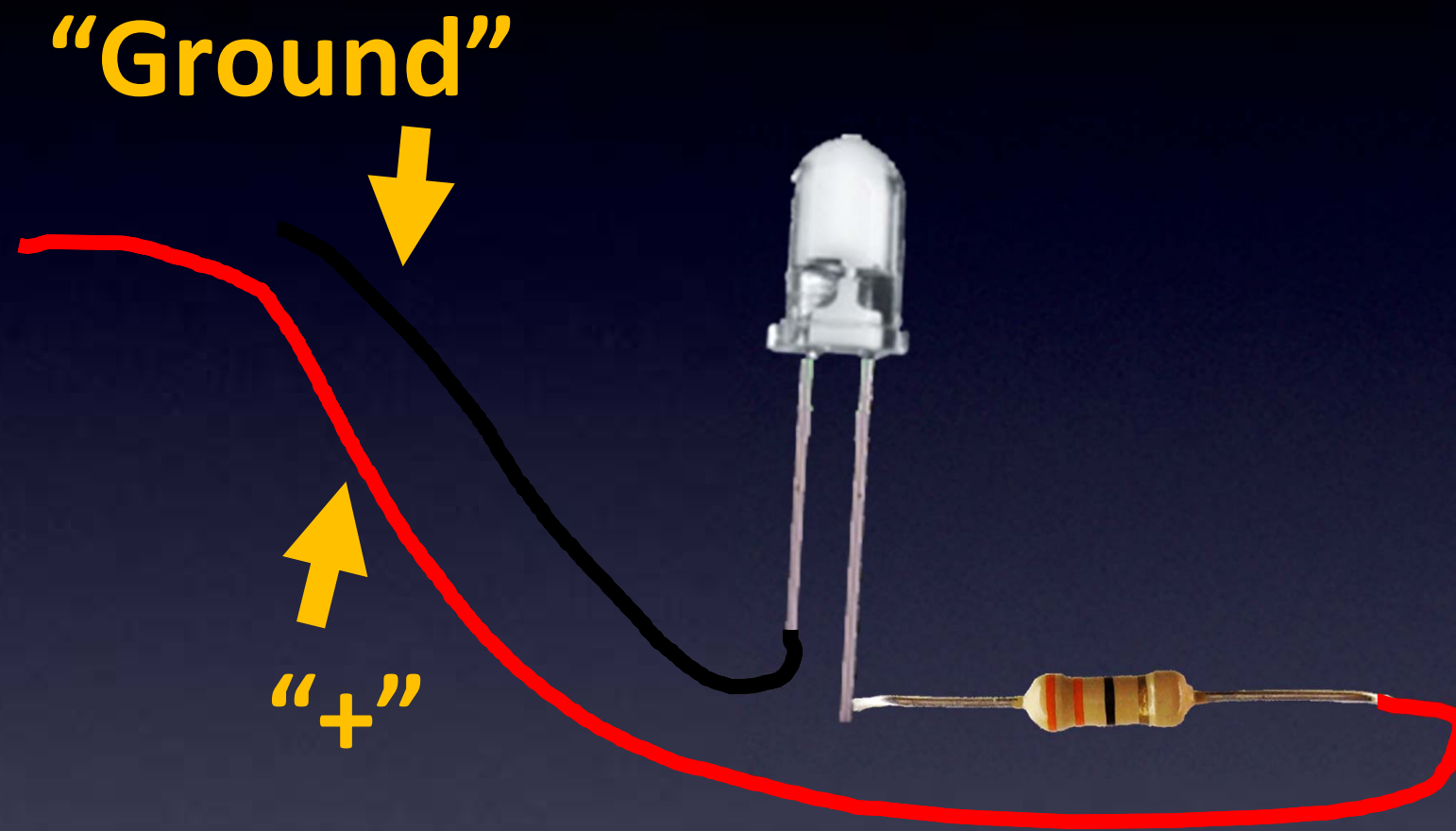

Turning an LED on and off

(Leading up to Hello World)

# Everything You Need to Know About Electronics

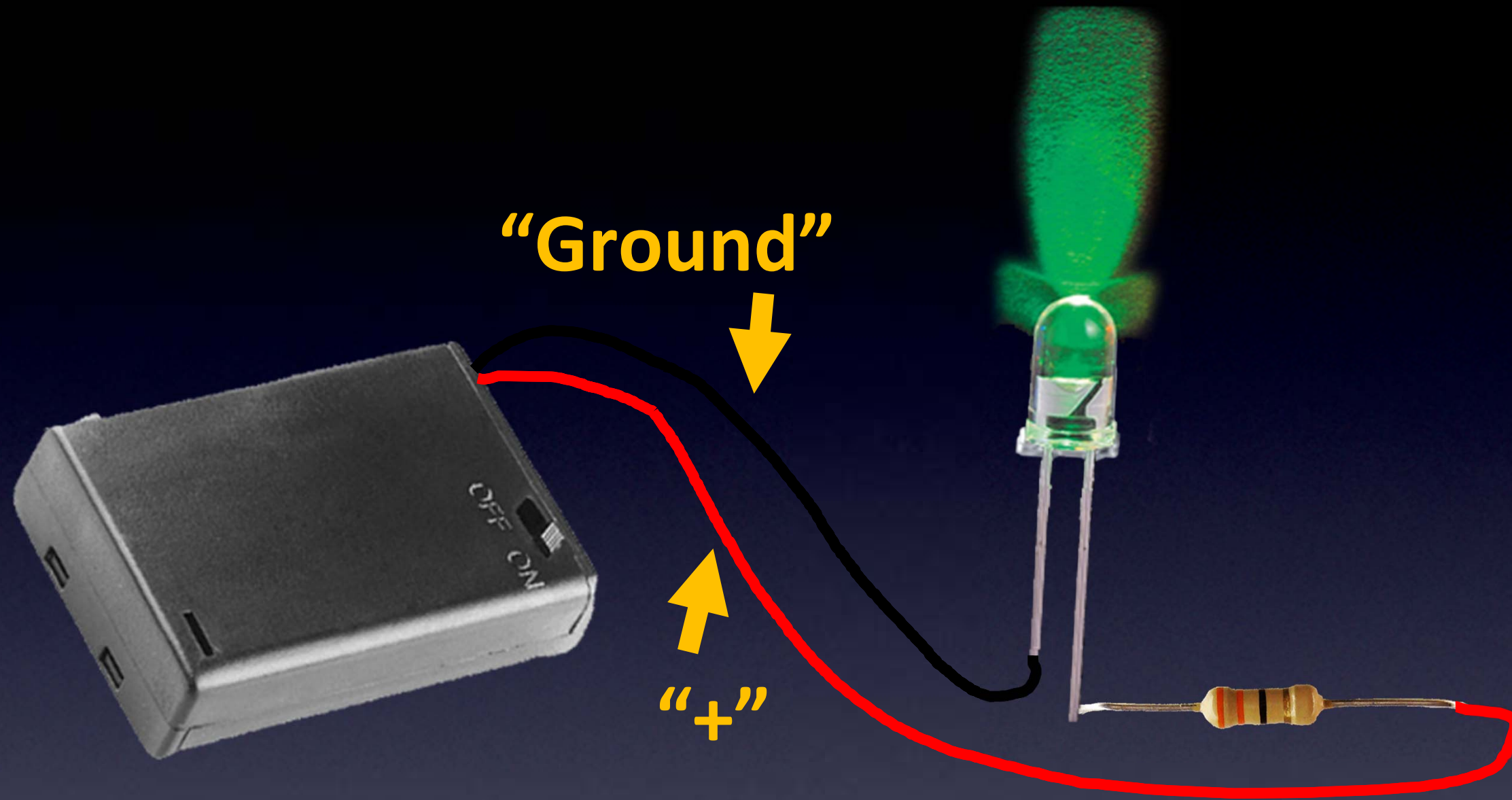

Turning an LED on and off

(Leading up to Hello World)

# Everything You Need to Know About Electronics

We can use an  
Output pin  
(and Ground)  
as our power  
supply

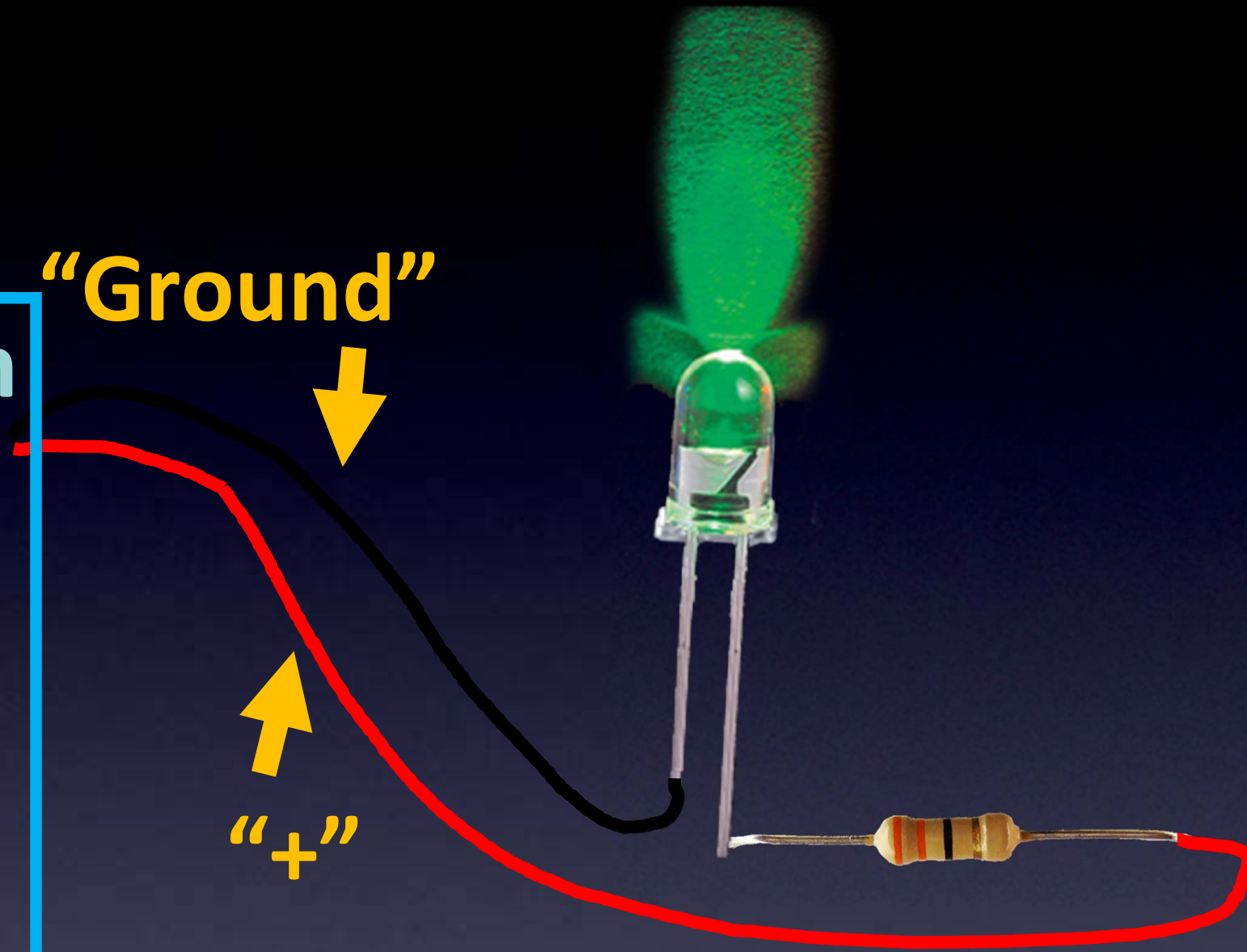

Turning an LED on and off

(Leading up to Hello World)



# Everything You Need to Know About Electronics

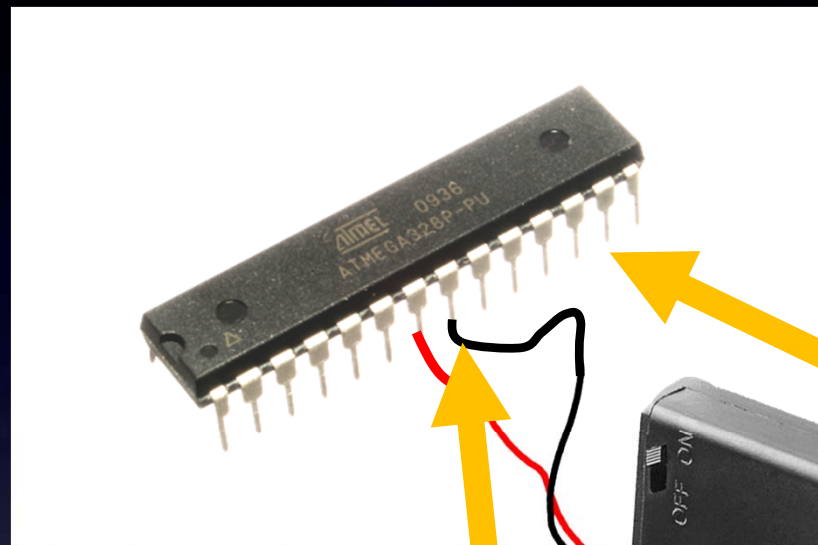

**Ground**

**Let's use Pin 13**  
as our **Output pin**  
*(it can be High or Low)*

**Turning an LED on and off**

(Leading up to Hello World)

# Everything You Need to Know About Electronics

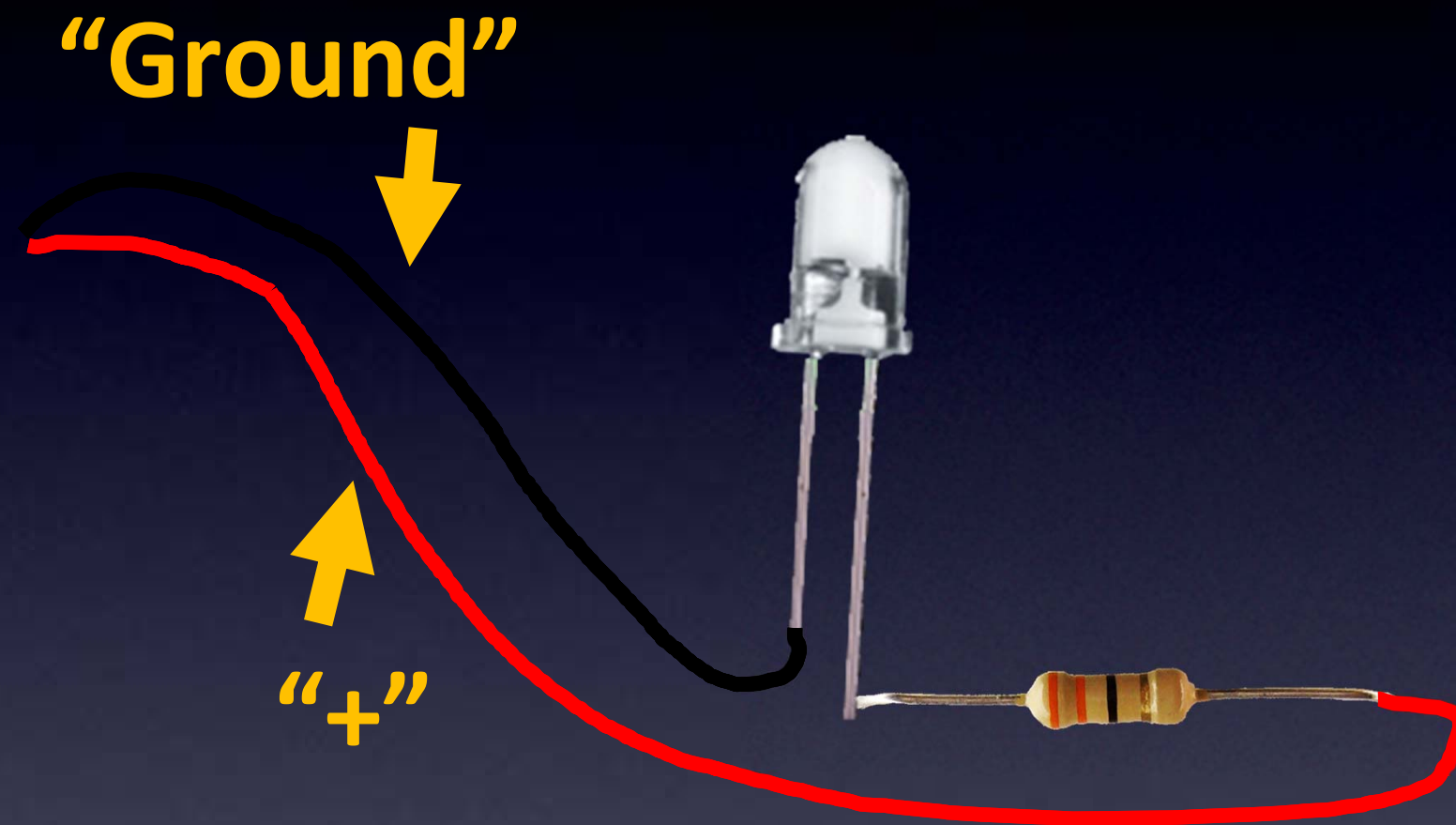

Turning an LED on and off

(Leading up to Hello World)

# Everything You Need to Know About Electronics

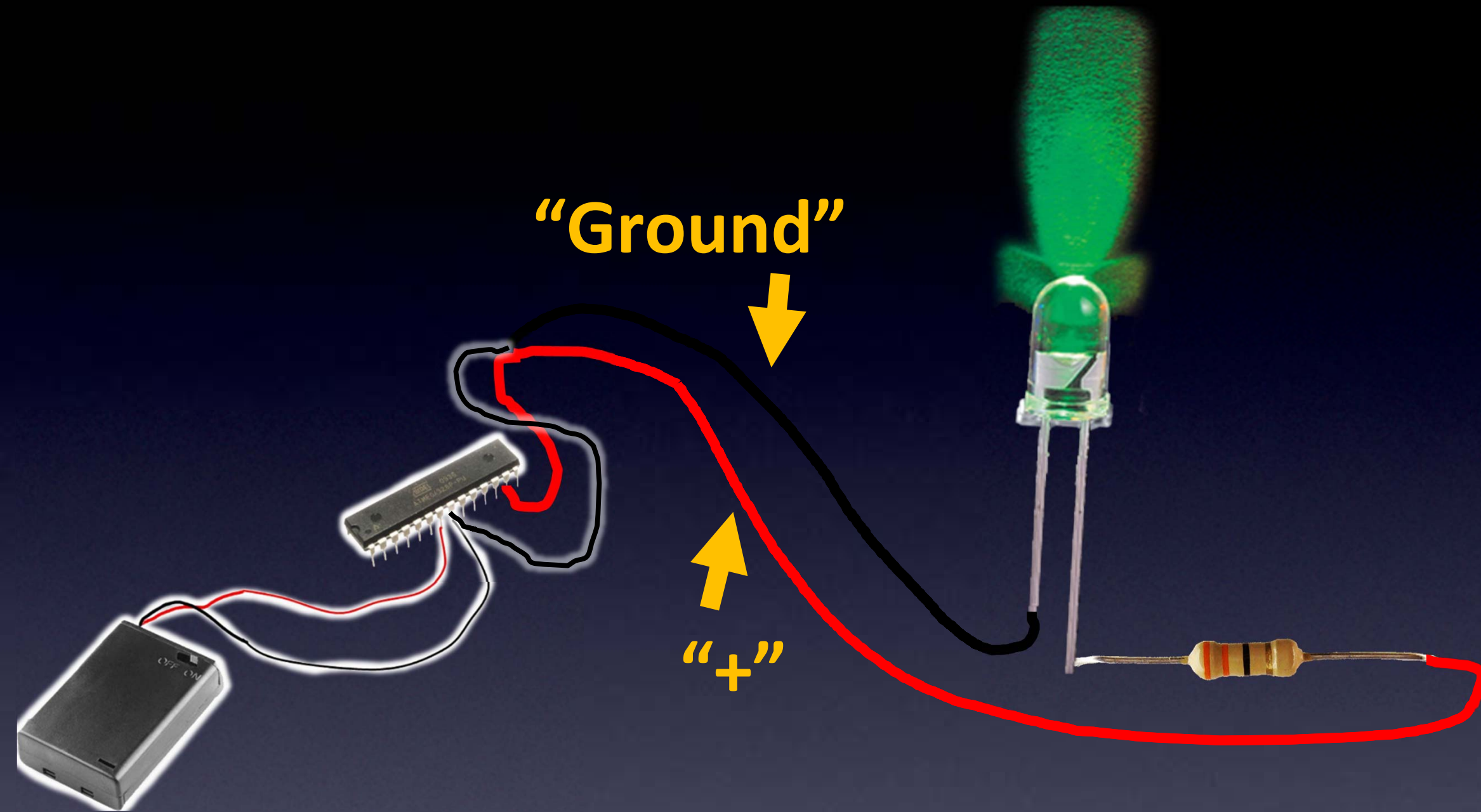

Turning an LED on and off

(Leading up to Hello World)

# Everything You Need to Know About Electronics

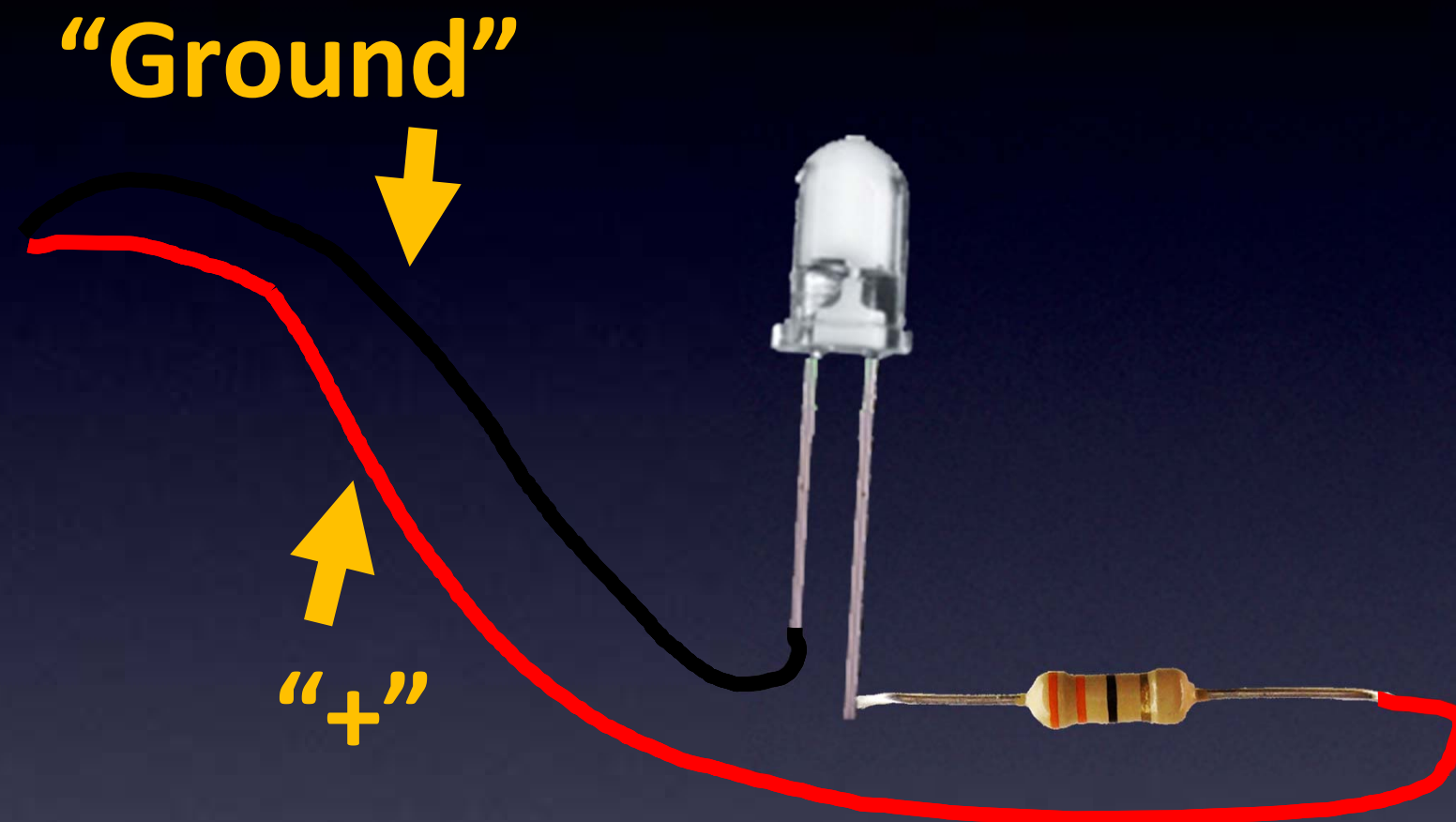

Turning an LED on and off

(Leading up to Hello World)

# Everything You Need to Know About Electronics

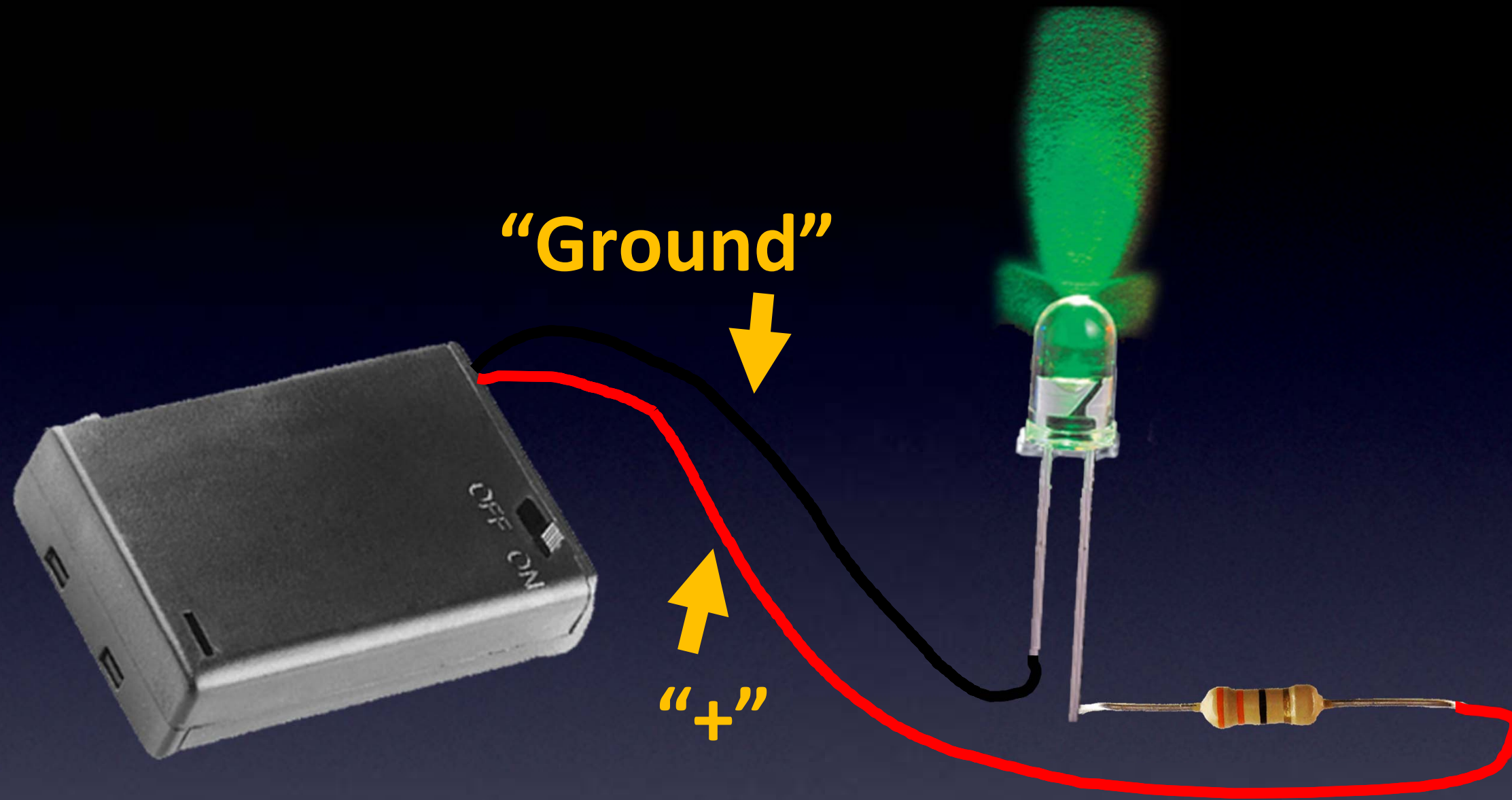

Turning an LED on and off

(Leading up to Hello World)

# Everything You Need to Know About Electronics

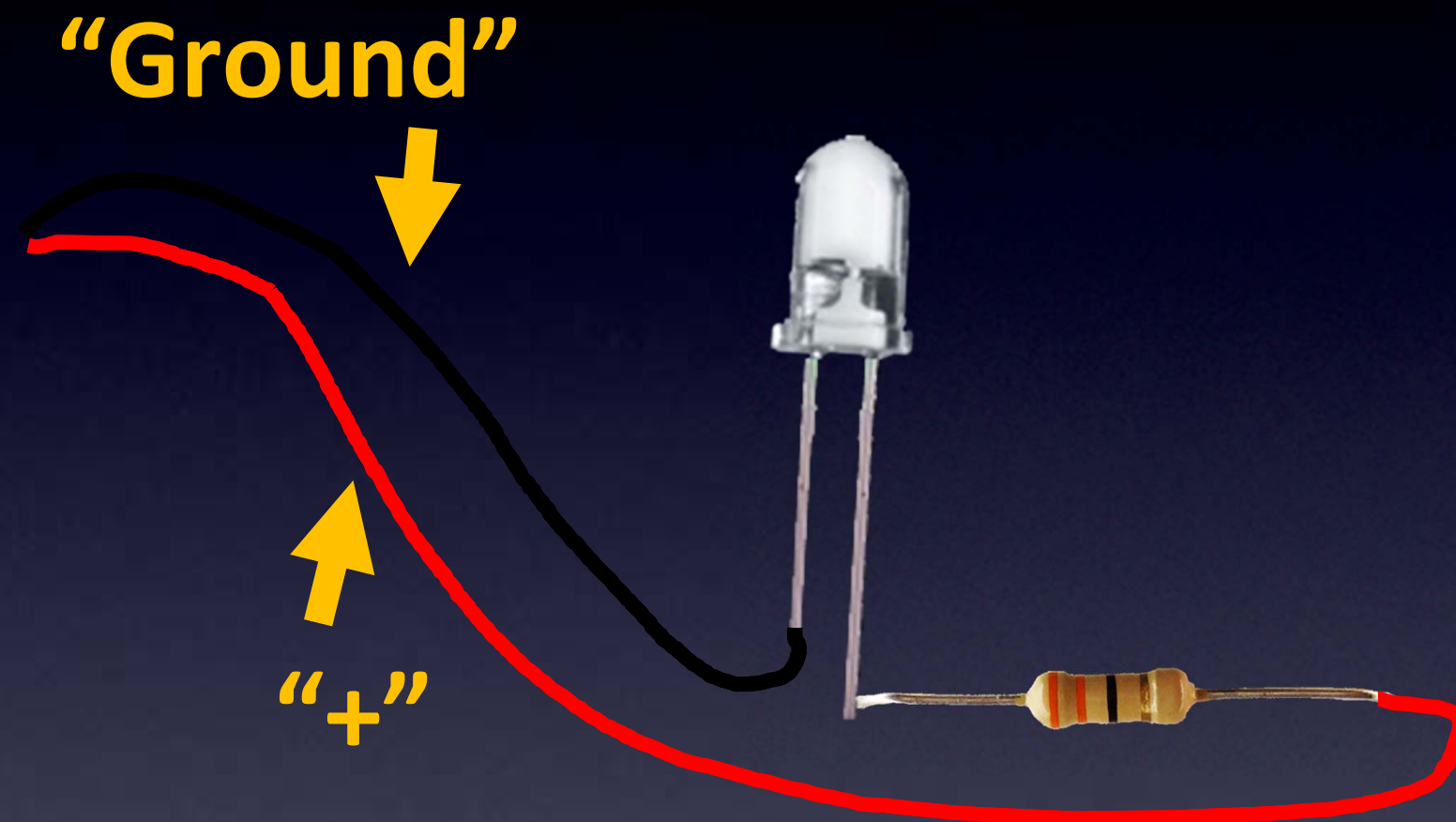

Turning an LED on and off

(Leading up to Hello World)

# Everything You Need to Know About Electronics

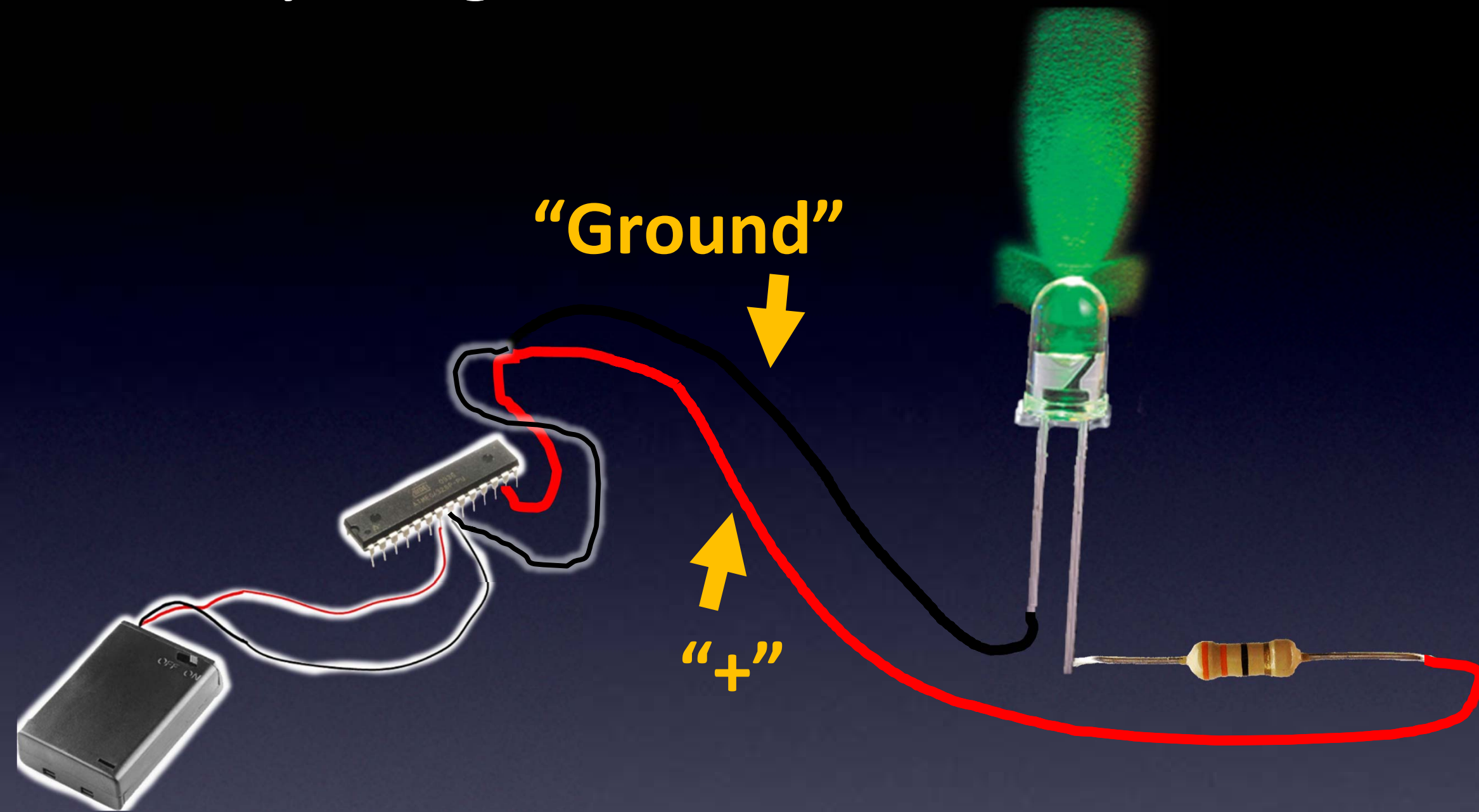

Turning an LED on and off

(Leading up to Hello World)

# Everything You Need to Know About Electronics

This is our Hardware for Hello World!

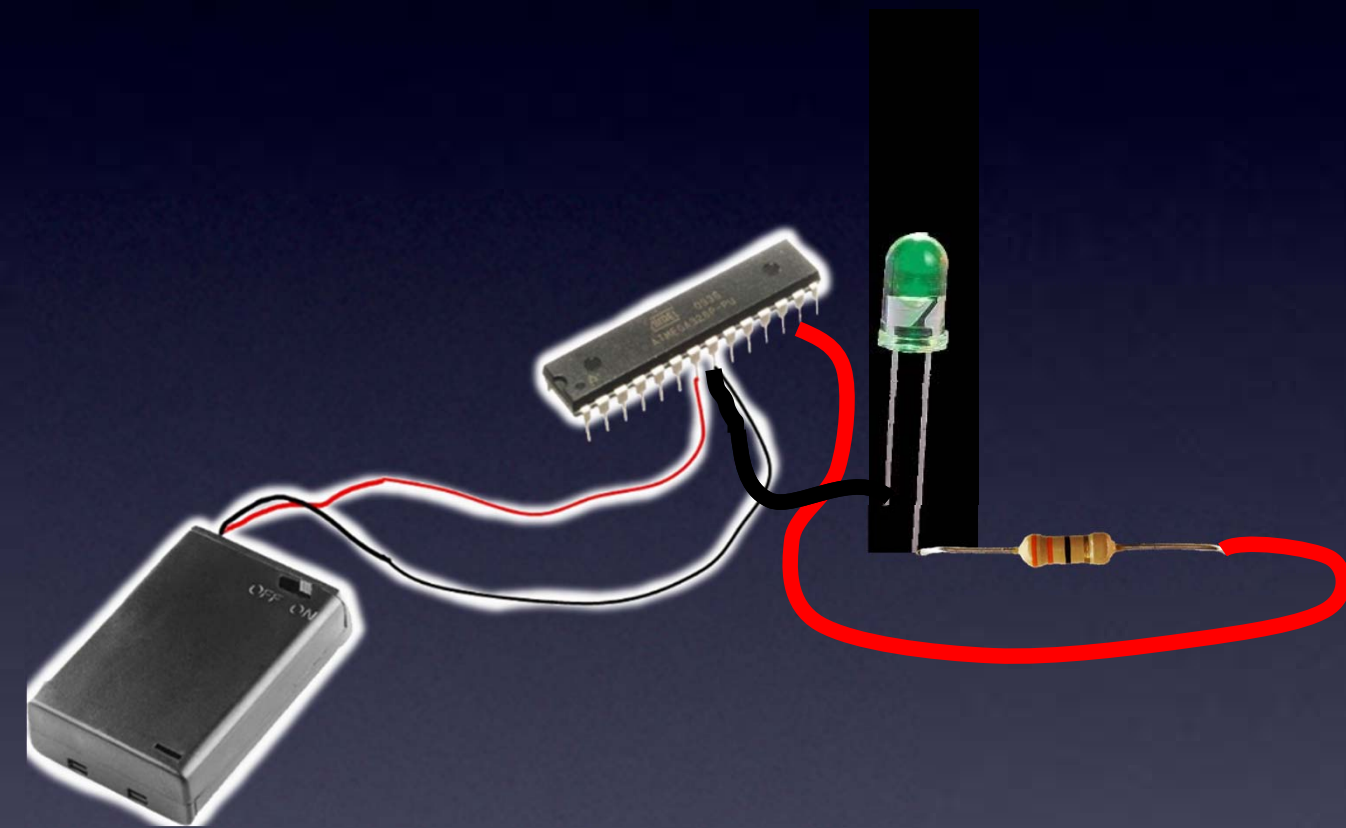

Turning an LED on and off

Hello World



# Everything You Need to Know About Electronics

How about our program?

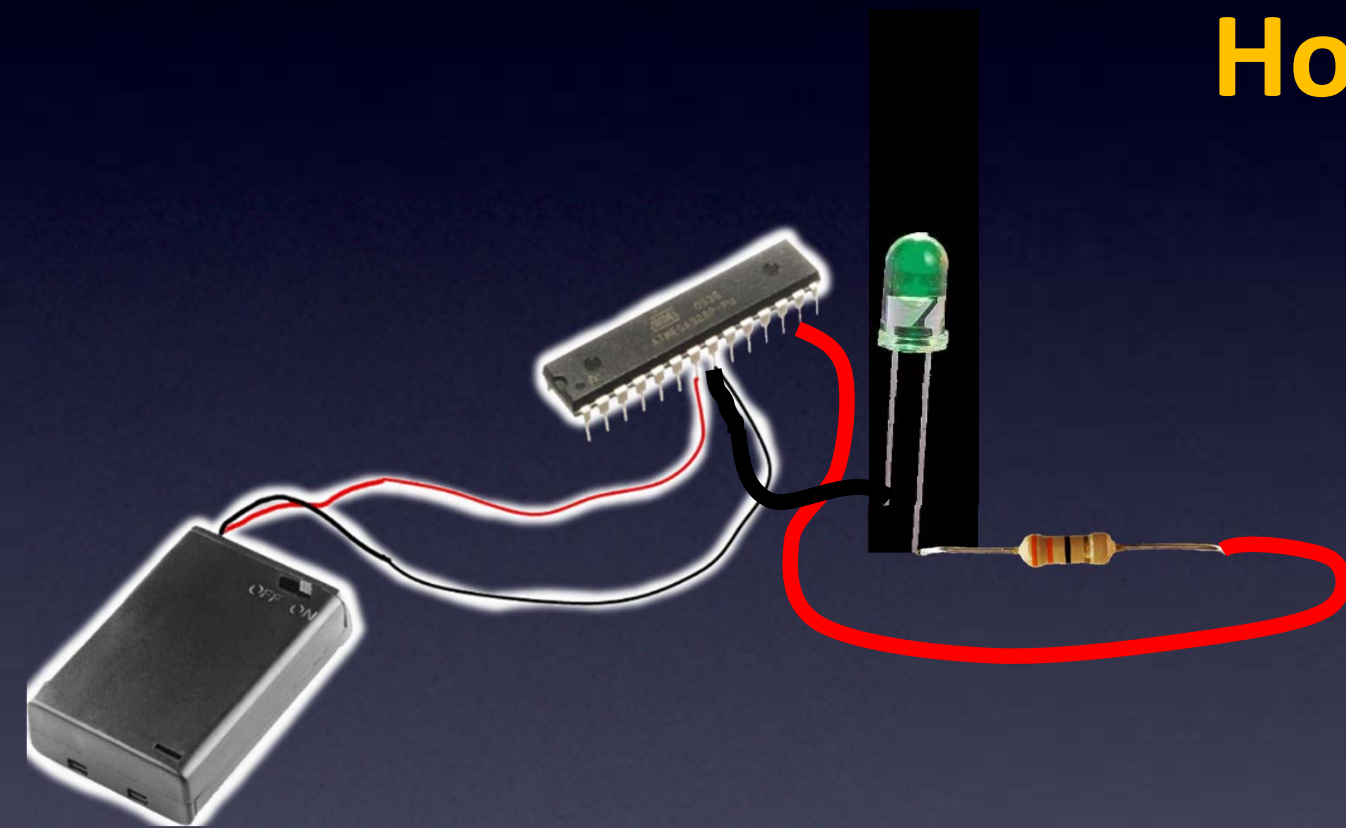

Turning an LED on and off

Hello World

# Everything You Need to Know About Electronics

Programs on microcontrollers are called **“Firmware”**

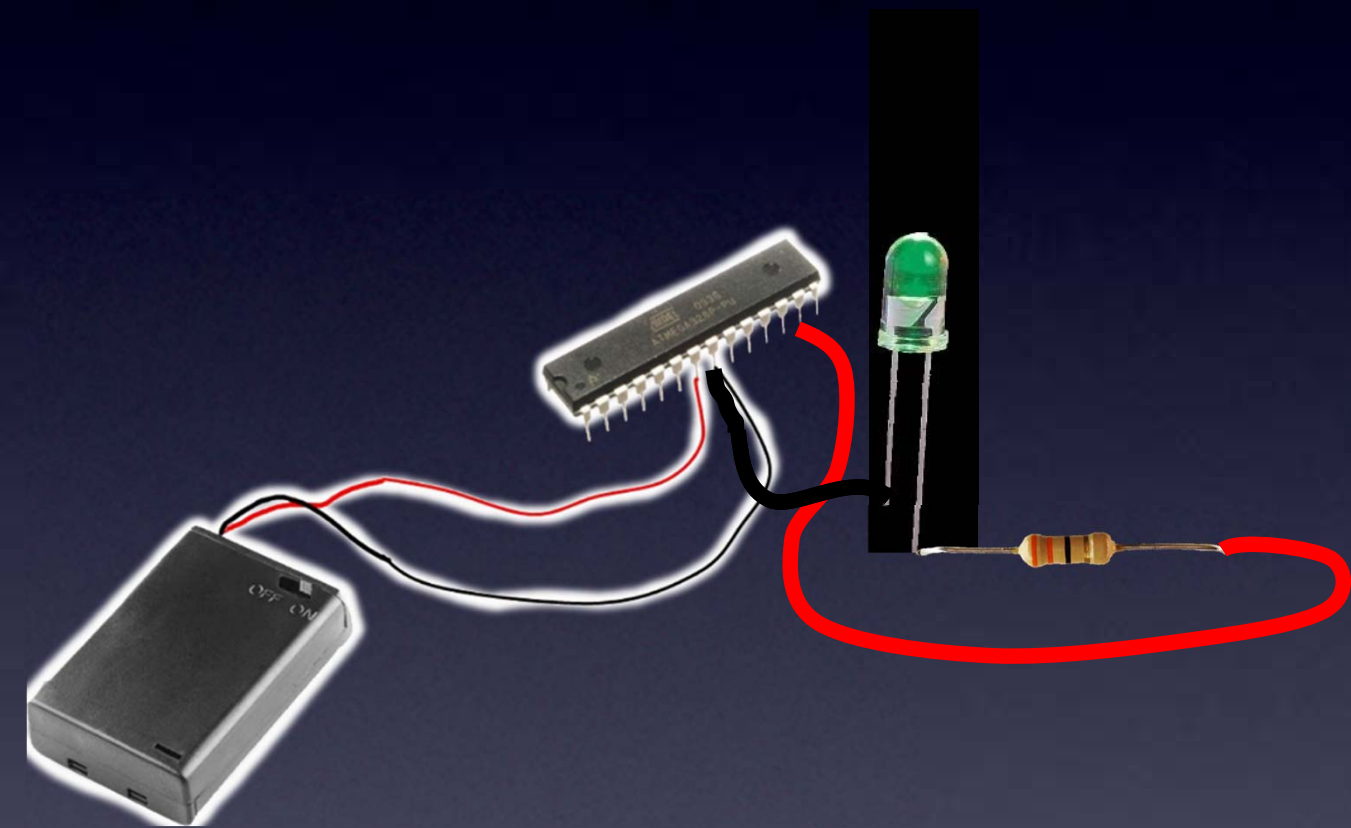

Turning an LED on and off

Hello World

# Everything You Need to Know About Electronics

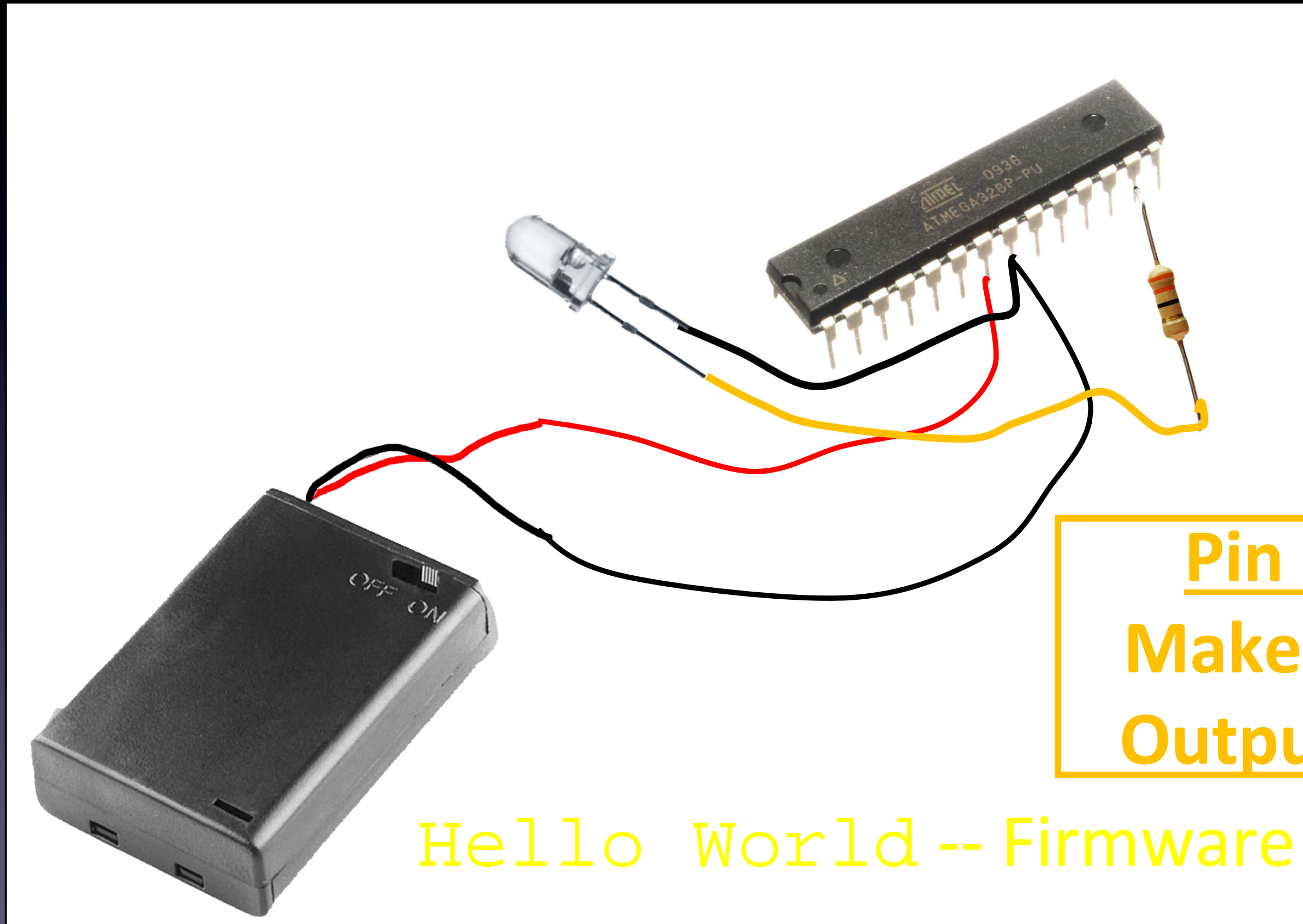

Pin 13:  
Make it an  
Output pin

Hello World -- Firmware

Microcontroller

# Everything You Need to Know About Electronics

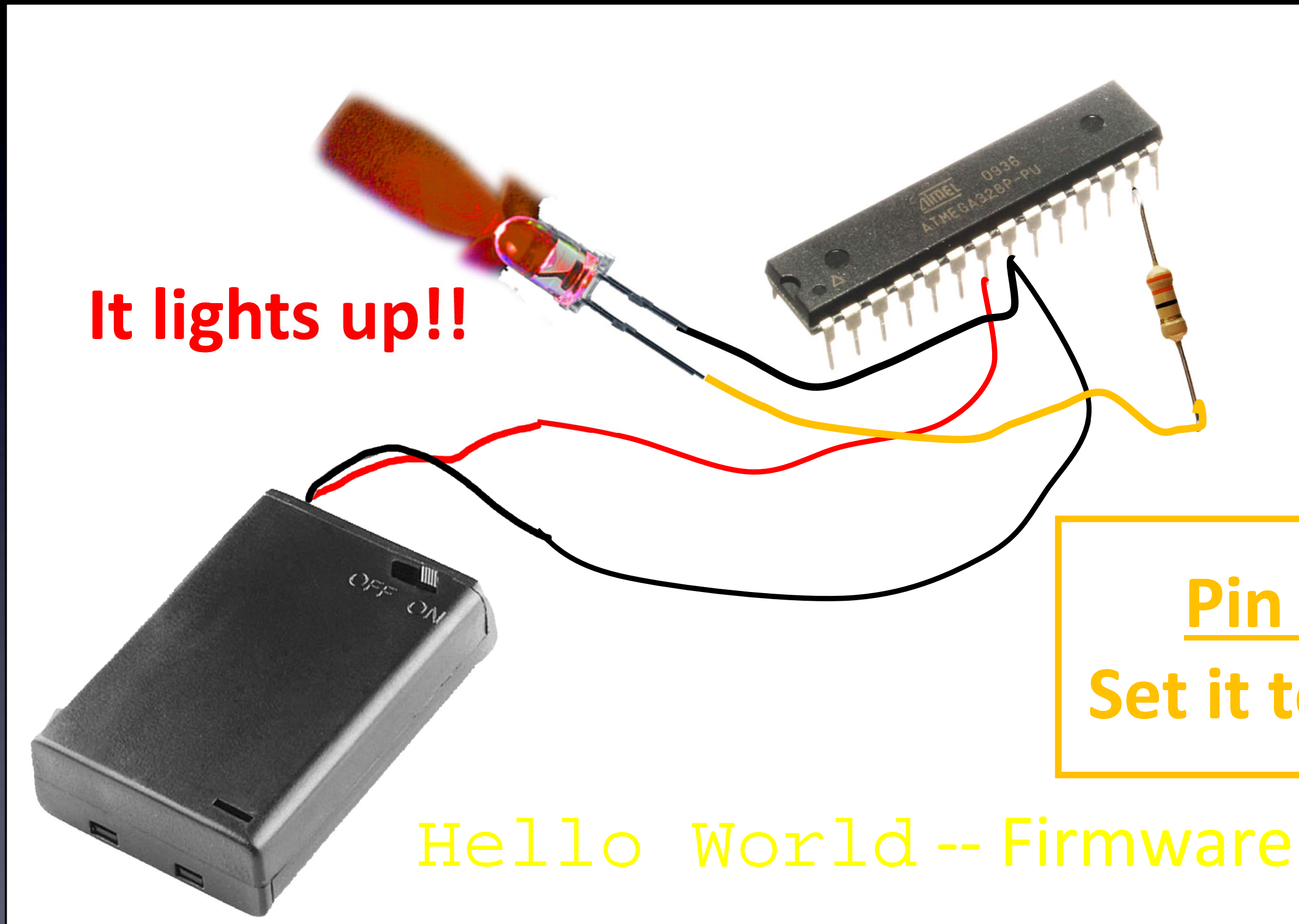

It lights up!!

Pin 13:  
Set it to High

Hello World -- Firmware

Microcontroller

# Everything You Need to Know About Electronics

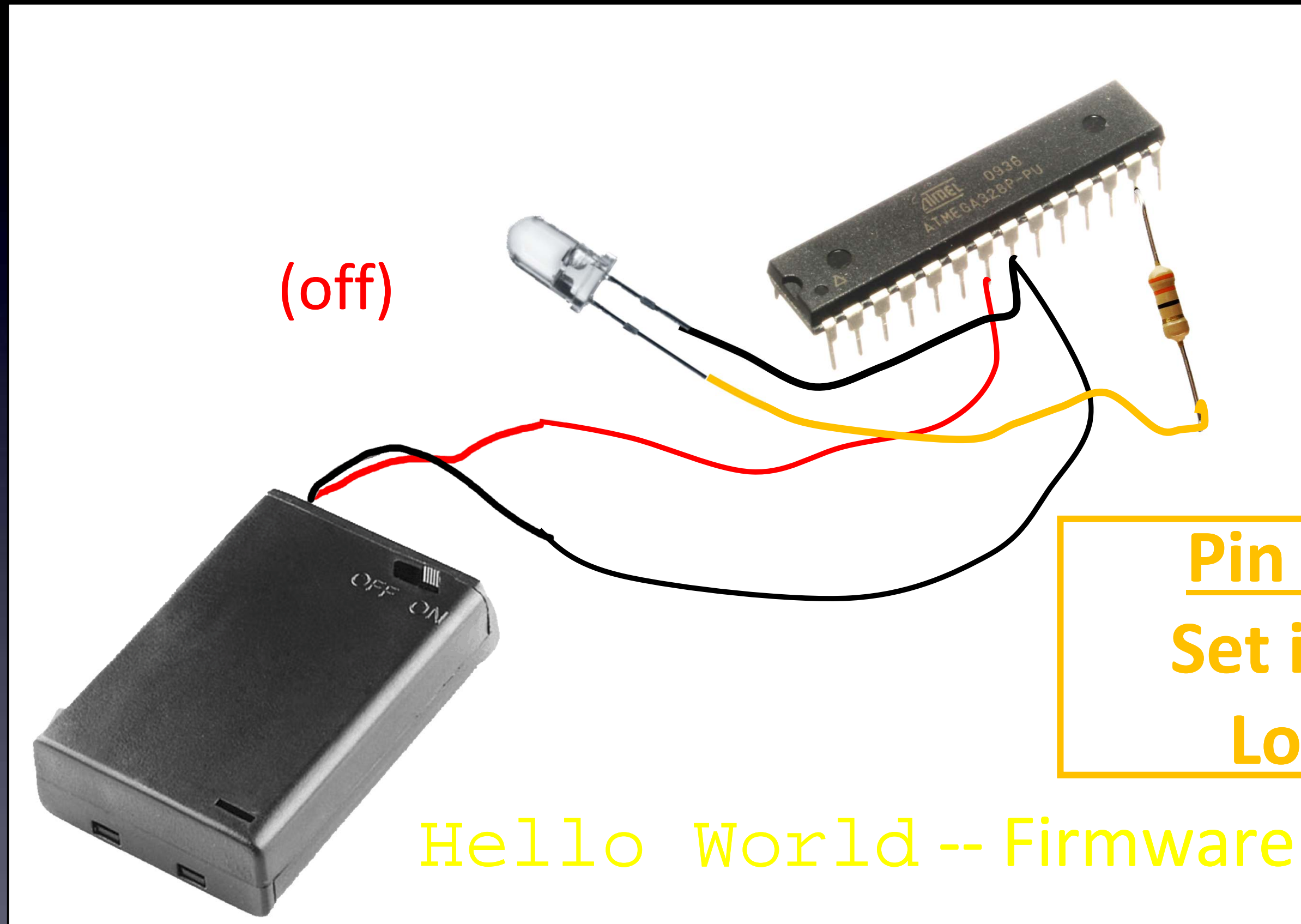

Microcontroller

# Everything You Need to Know About Electronics



We now have  
Hello World !

Microcontroller

# Everything You Need to Know About Electronics

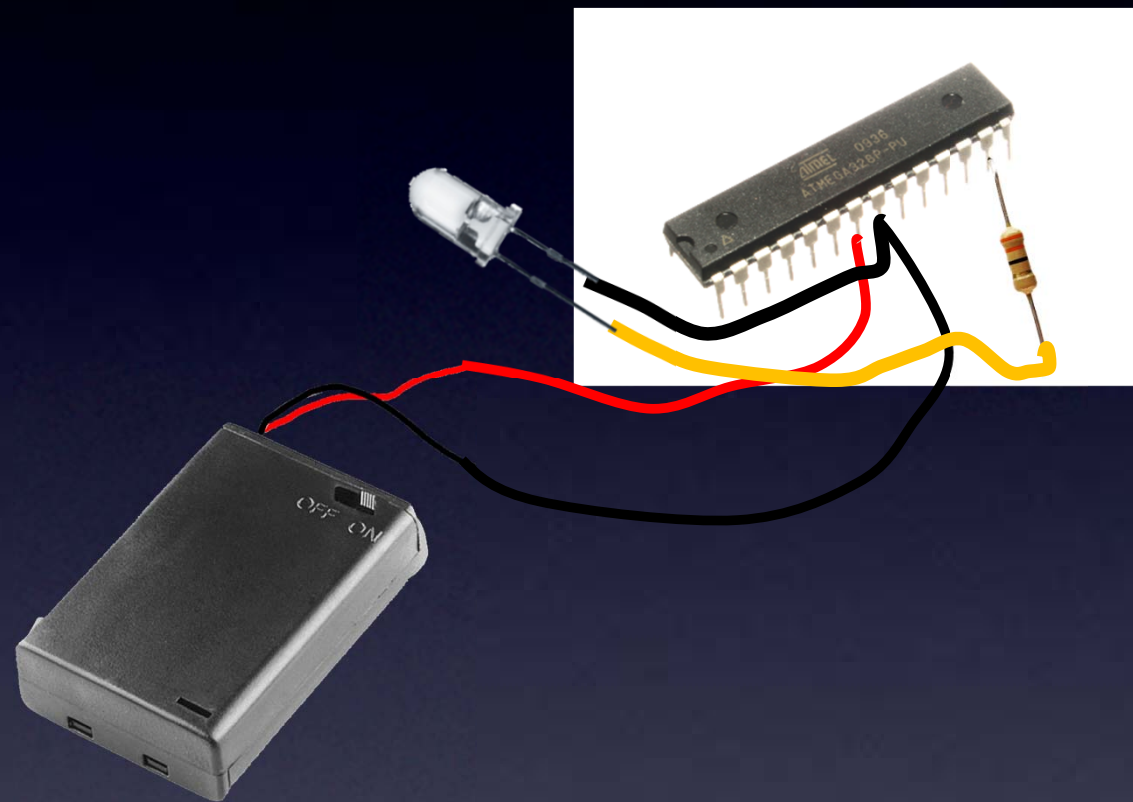

We now have  
Hello World !

**Except**

We won't see it



Microcontroller

# Everything You Need to Know About Electronics

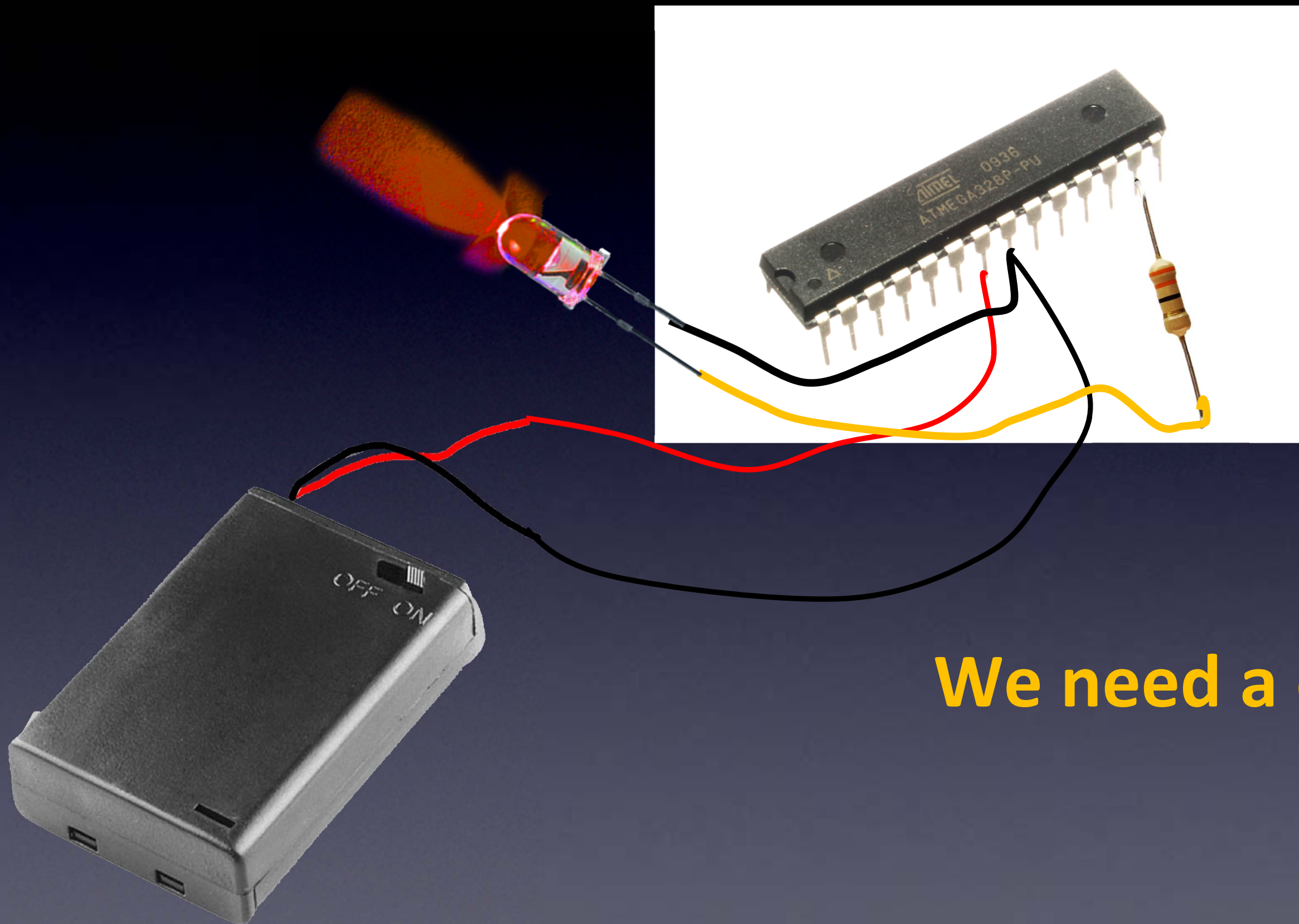

**We need a delay**

Microcontrollers – they go really fast!



# Everything You Need to Know About Electronics

## Hardware

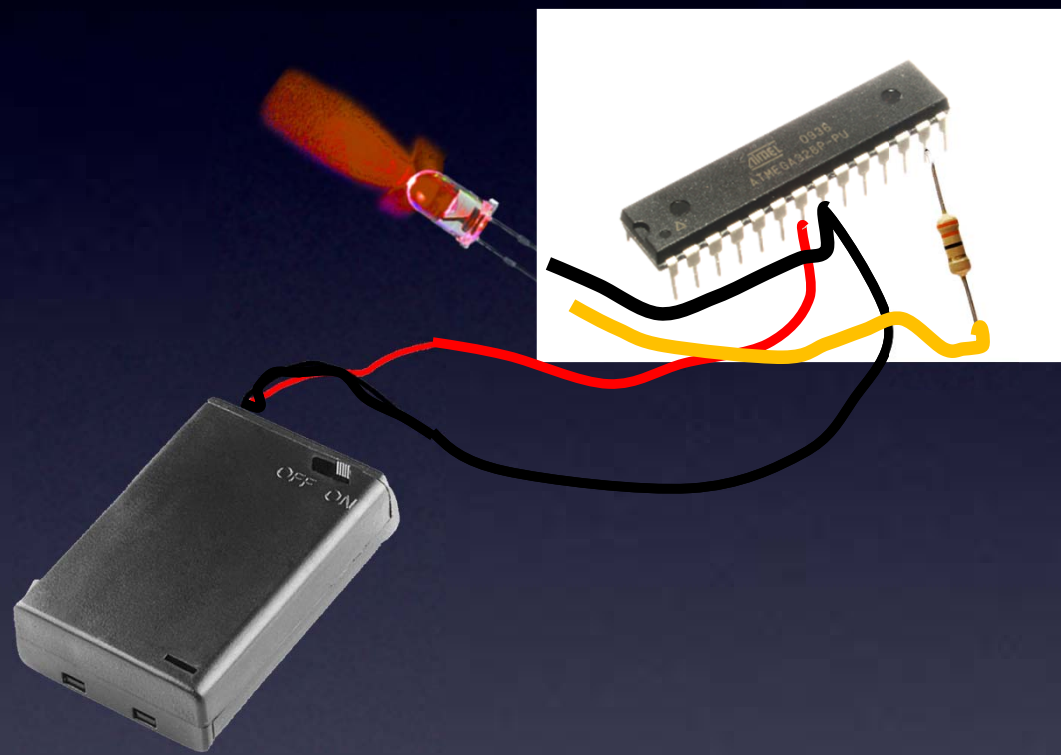

## Firmware

- pin 13 is Output pin
- set pin 13 High
- delay
- set pin 13 Low

Hello World – for real now!

Microcontroller – Firmware

# Everything You Need to Know About Electronics

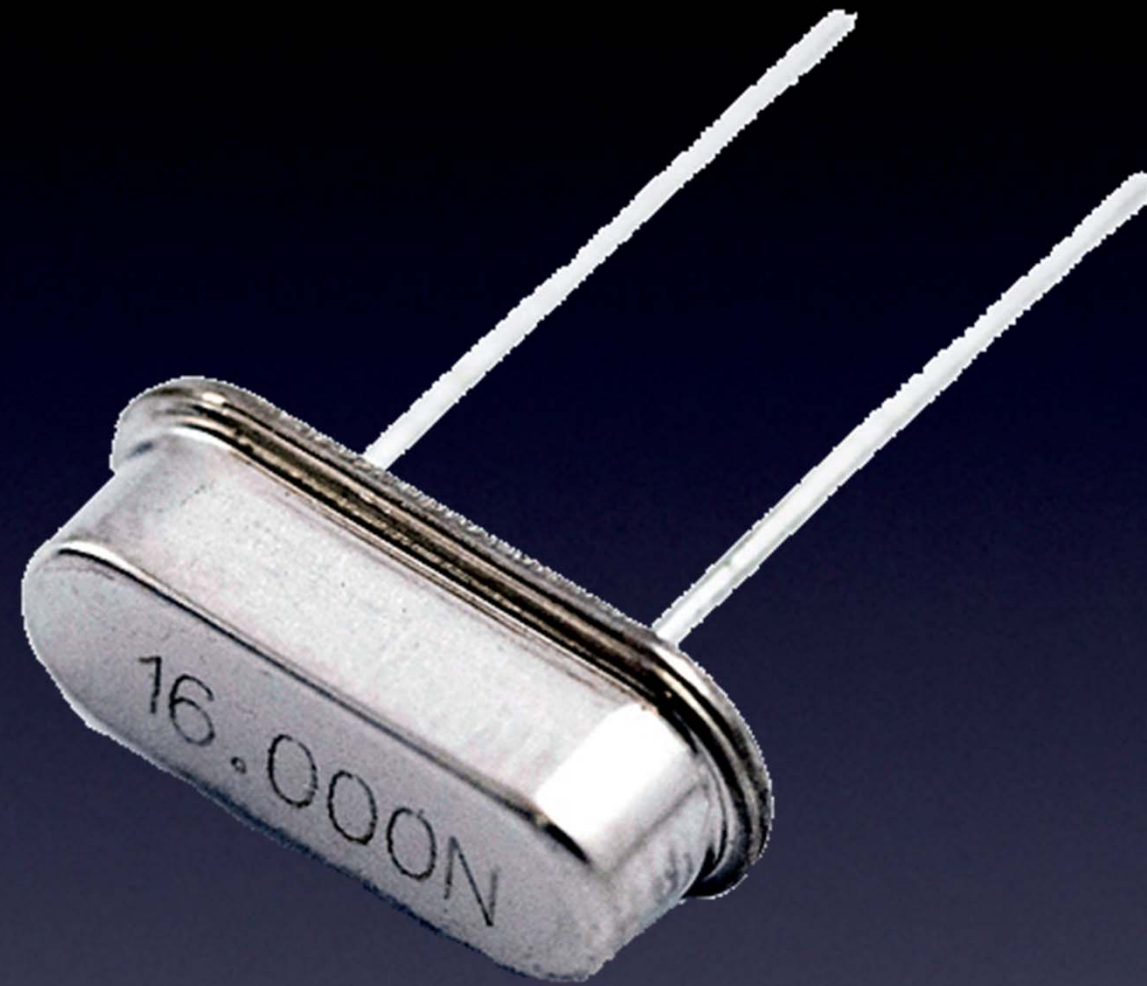

**A precision cut piece of quartz crystal**

**For precise timing**

Crystal

# Everything You Need to Know About Electronics

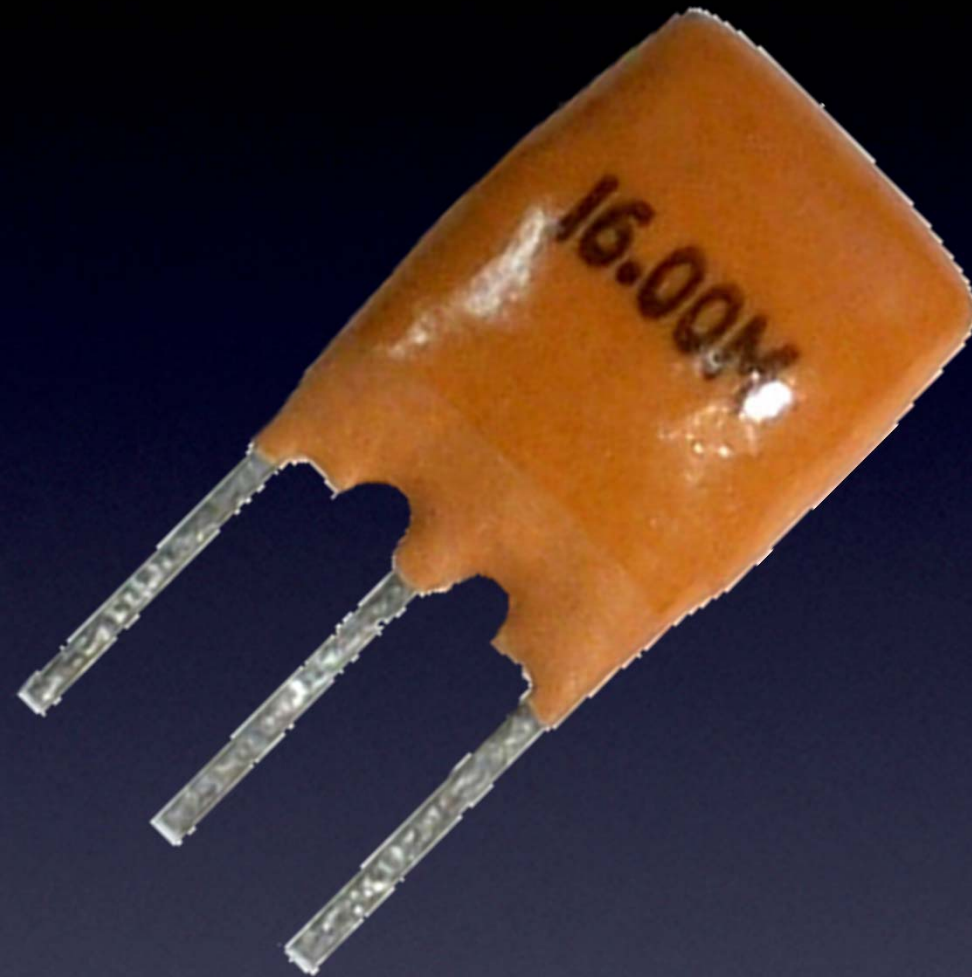

**A bunch of resistors and capacitors**

**For precise timing (but less than a crystal)**

Ceramic Resonator

# Everything You Need to Know About Electronics

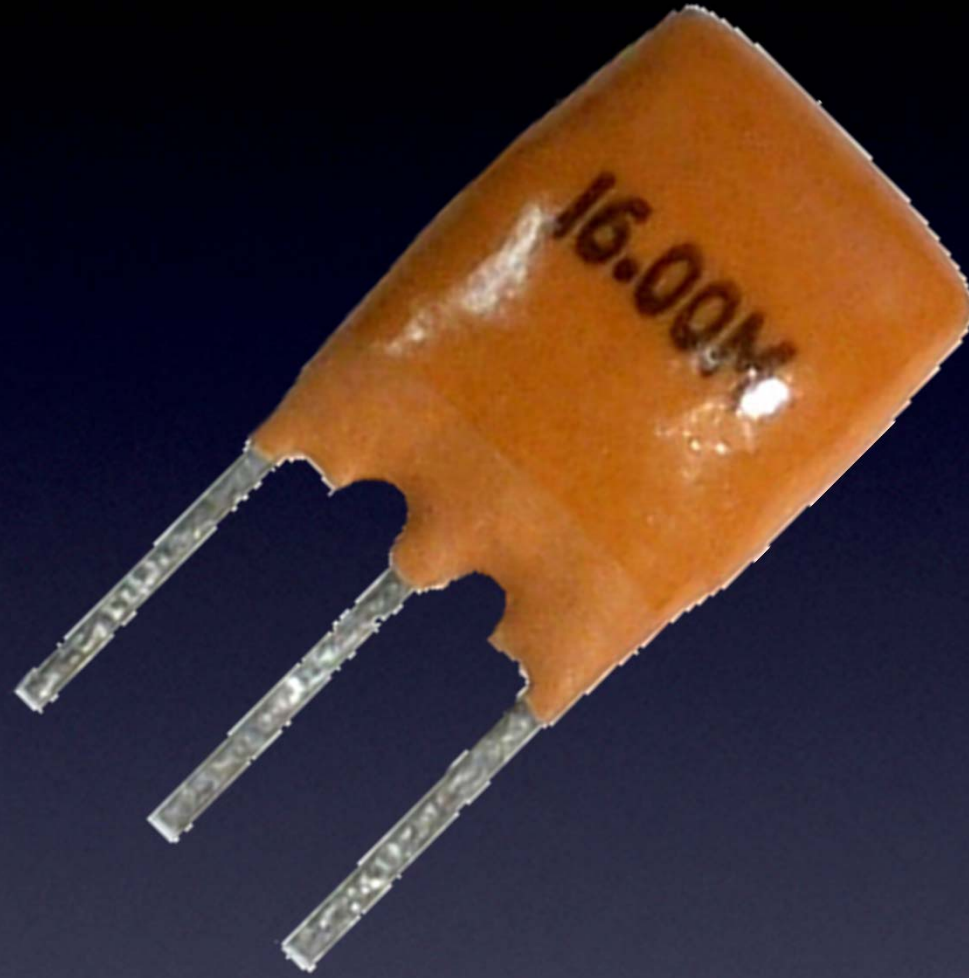

Frequency, measured in **Hertz**

For precise timing (but less than a crystal)

Ceramic Resonator / **Hertz**

# Everything You Need to Know About Electronics

## Hardware

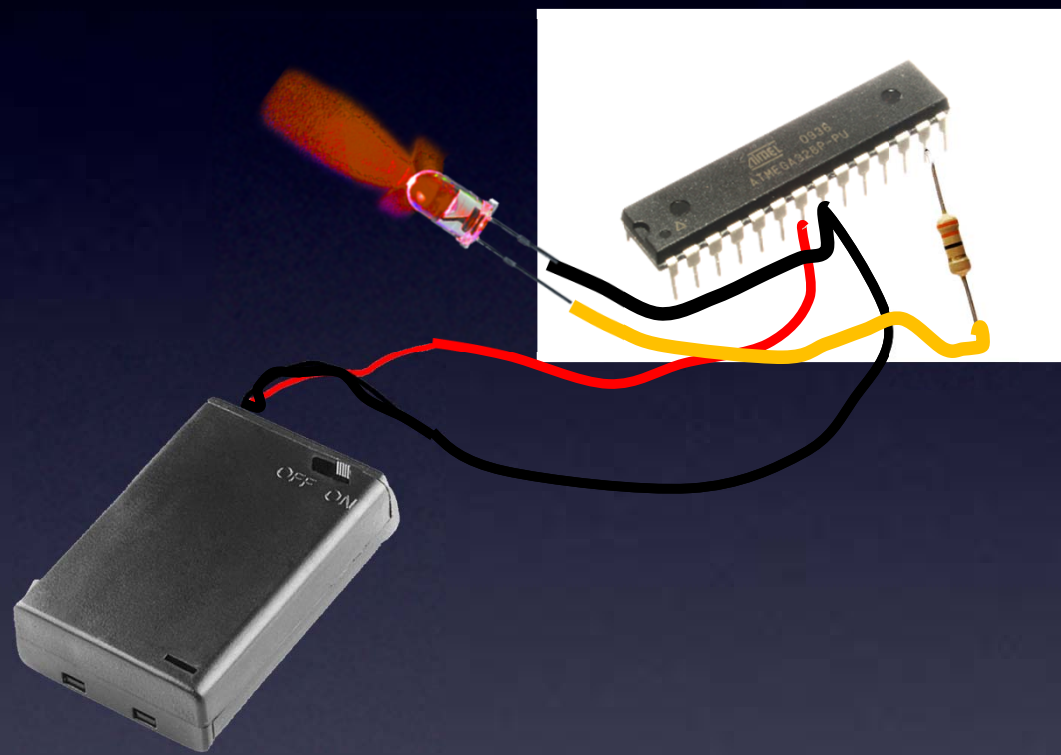

## Firmware

- pin 13 is Output pin
- set pin 13 High
- delay
- set pin 13 Low

# Let's hack Hello World!

Microcontroller

# Everything You Need to Know About Electronics

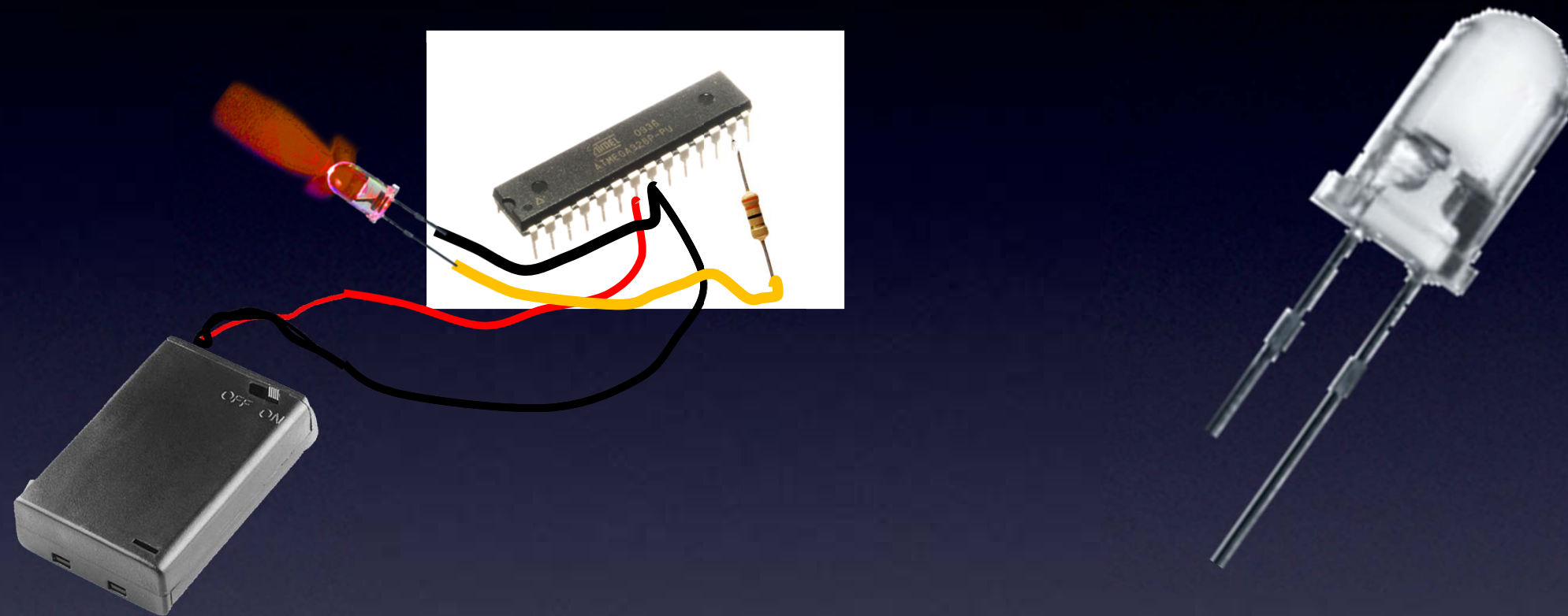

**Add an IR LED to another pin**

**IR "OFF" codes**

Microcontroller

# Everything You Need to Know About Electronics

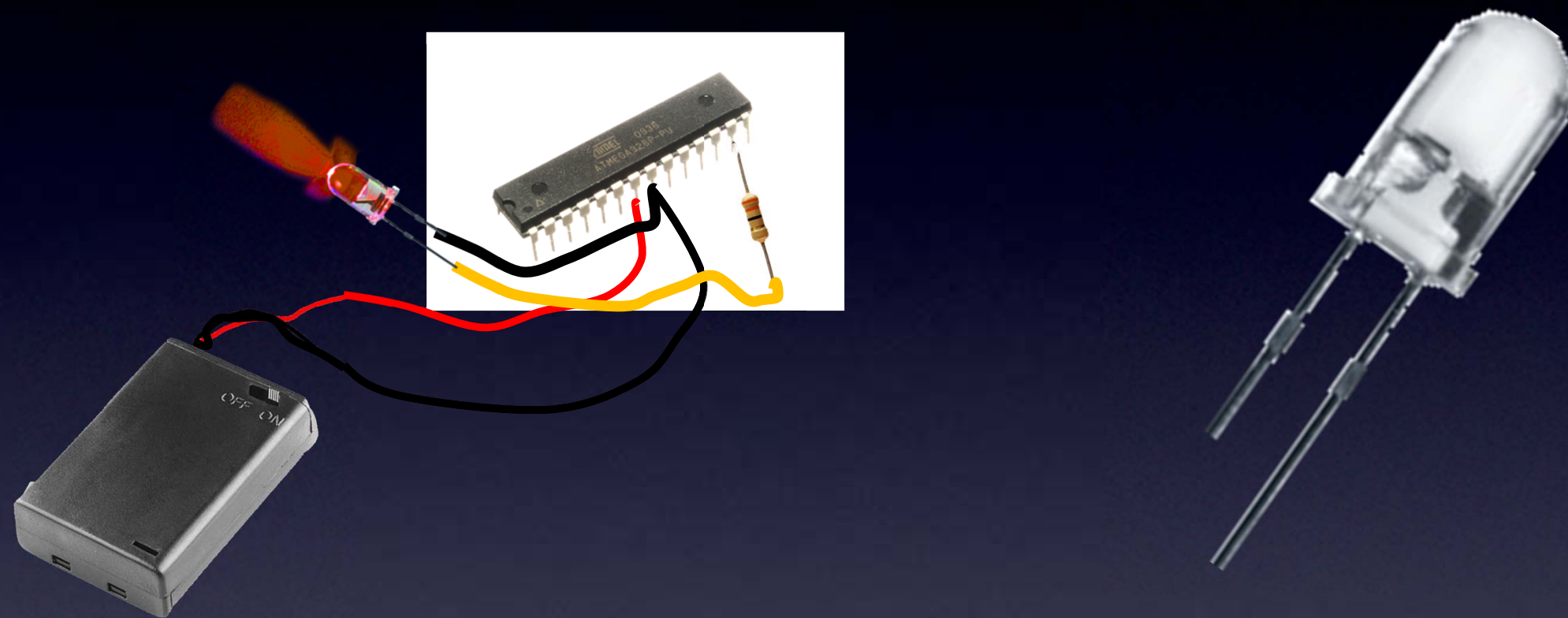

**Add an IR LED to another pin (say, pin3)**

**IR "OFF" codes**

Microcontroller

# Everything You Need to Know About Electronics

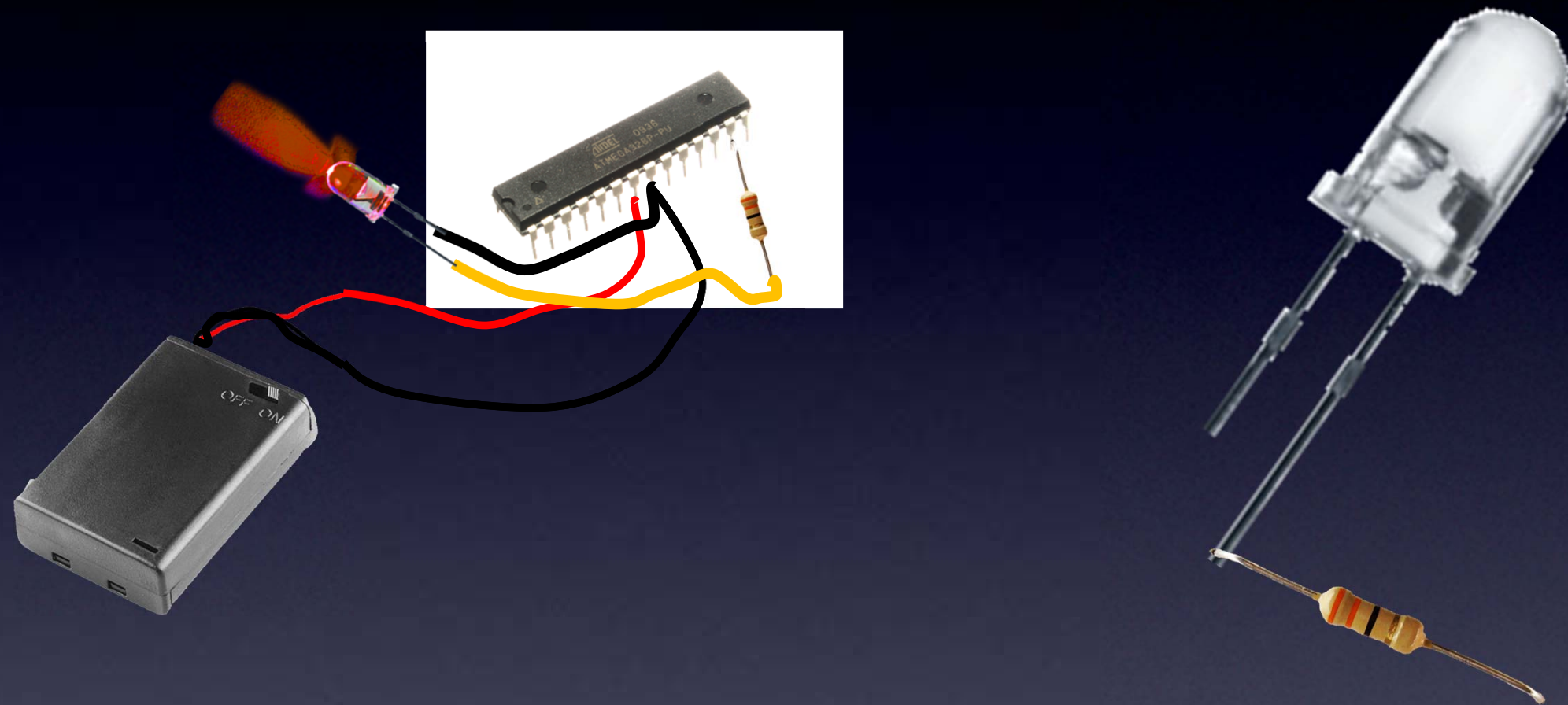

**Add an IR LED to another pin (say, pin3)**  
*and a resistor so no magic smoke goes away*

**IR "OFF" codes**

**Microcontroller**



# Everything You Need to Know About Electronics

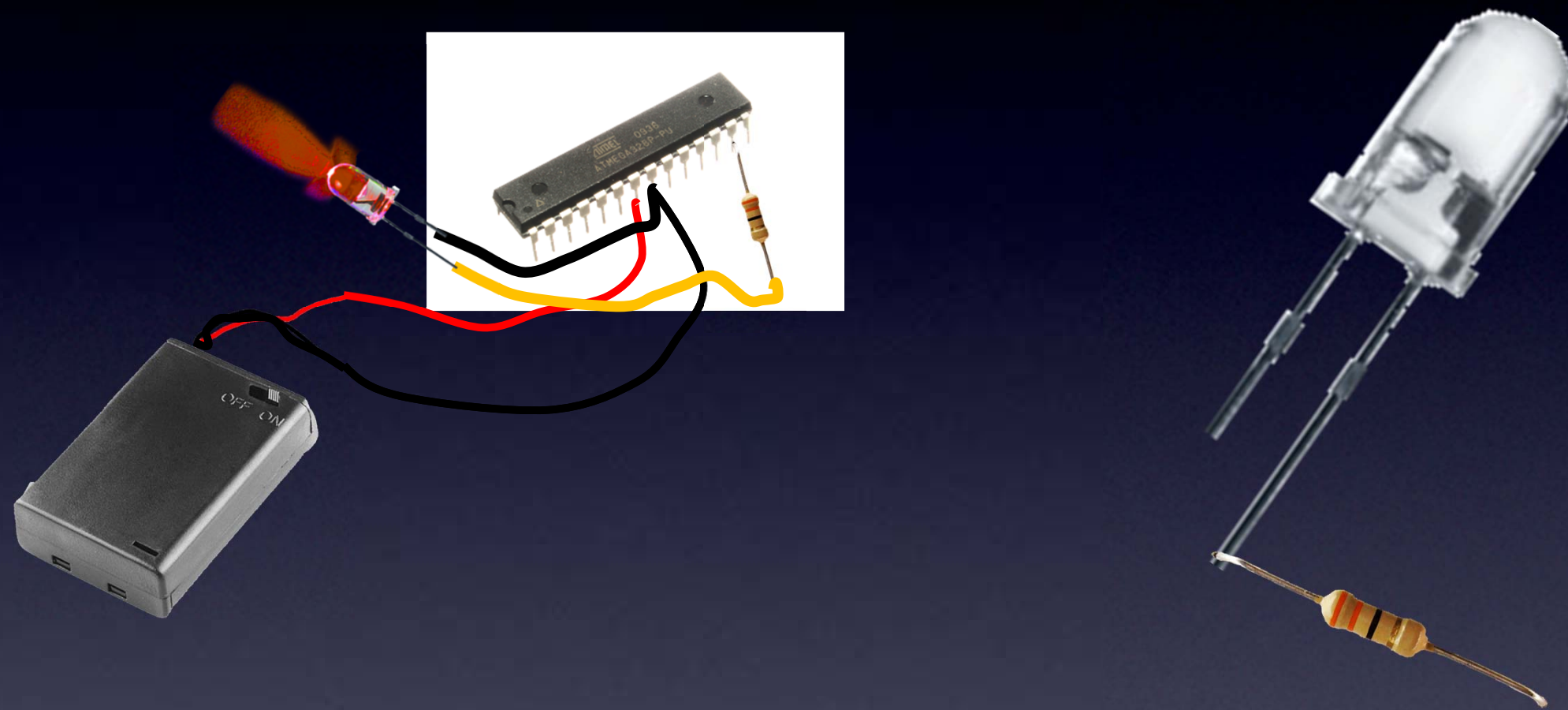

But, *When?*

IR "OFF" codes

Microcontroller

# Everything You Need to Know About Electronics

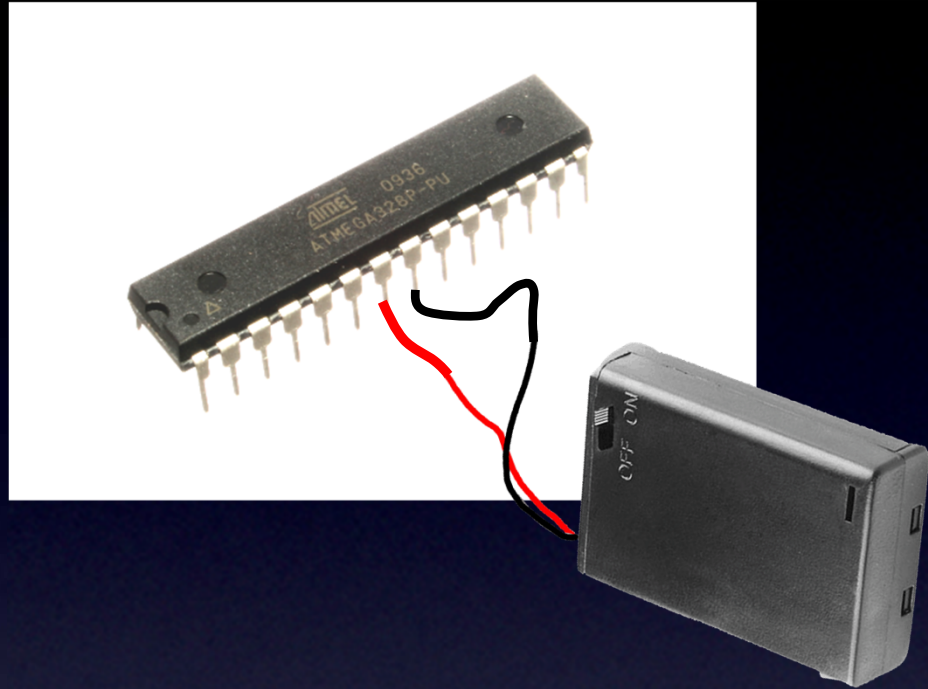

Let's add an Input pin!

and

We can add a Start button

Microcontroller

# Everything You Need to Know About Electronics

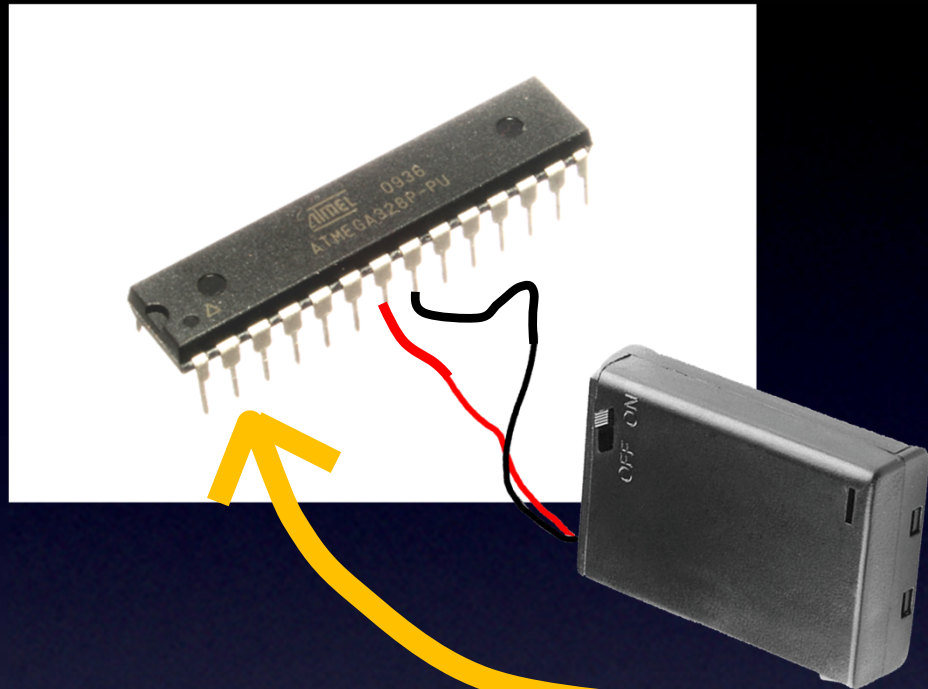

**How do we make a pin an Input pin?**

**We tell it to be one – with our program.**

***Any pin can be an Input pin (like, pin 2).***

**Microcontroller – Input pins**

# Everything You Need to Know About Electronics

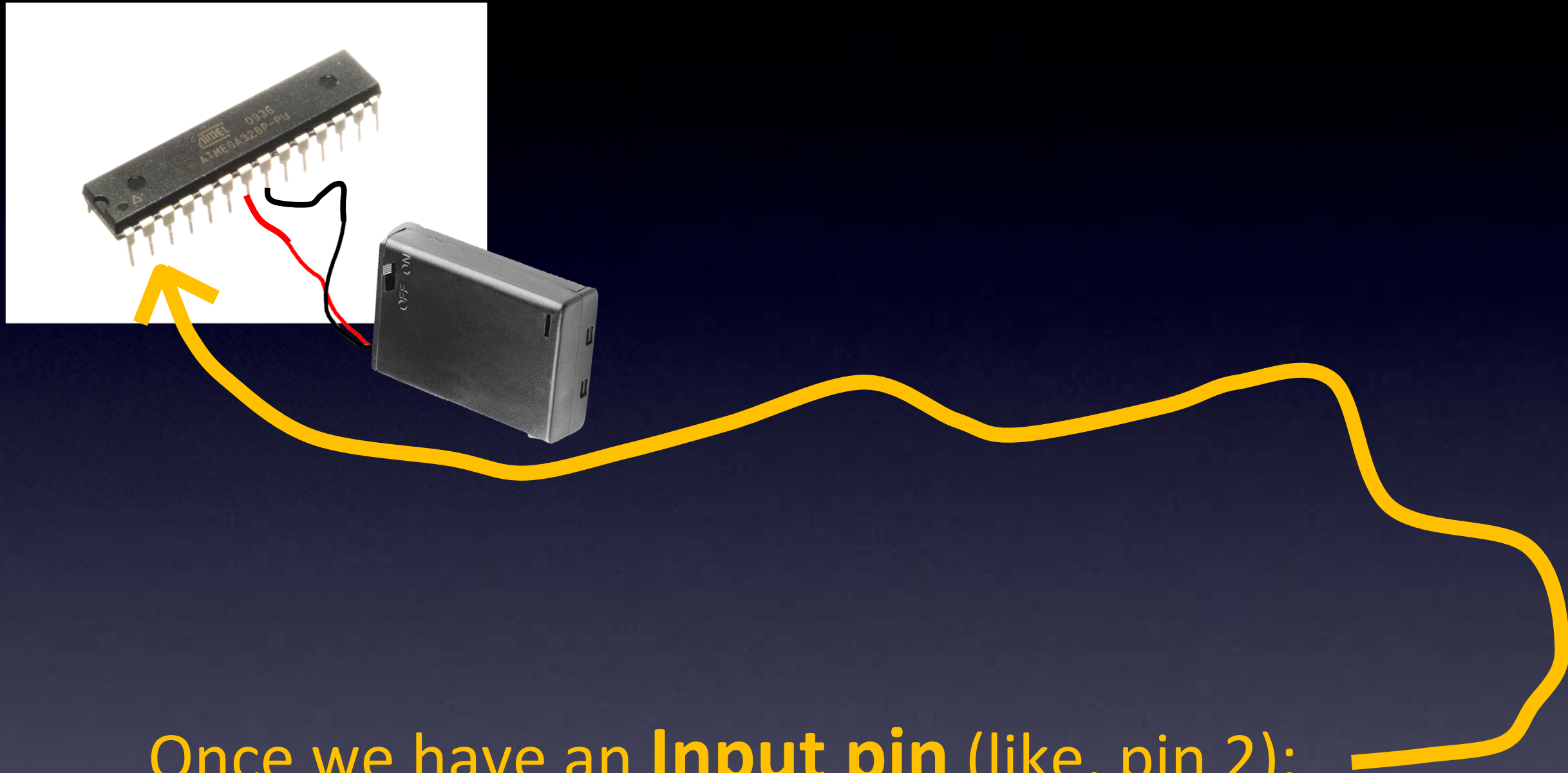

Once we have an **Input pin** (like, pin 2):

only 2 choices – is the Input pin: **High** or **Low** ?

Microcontroller – Input pins

# Everything You Need to Know About Electronics

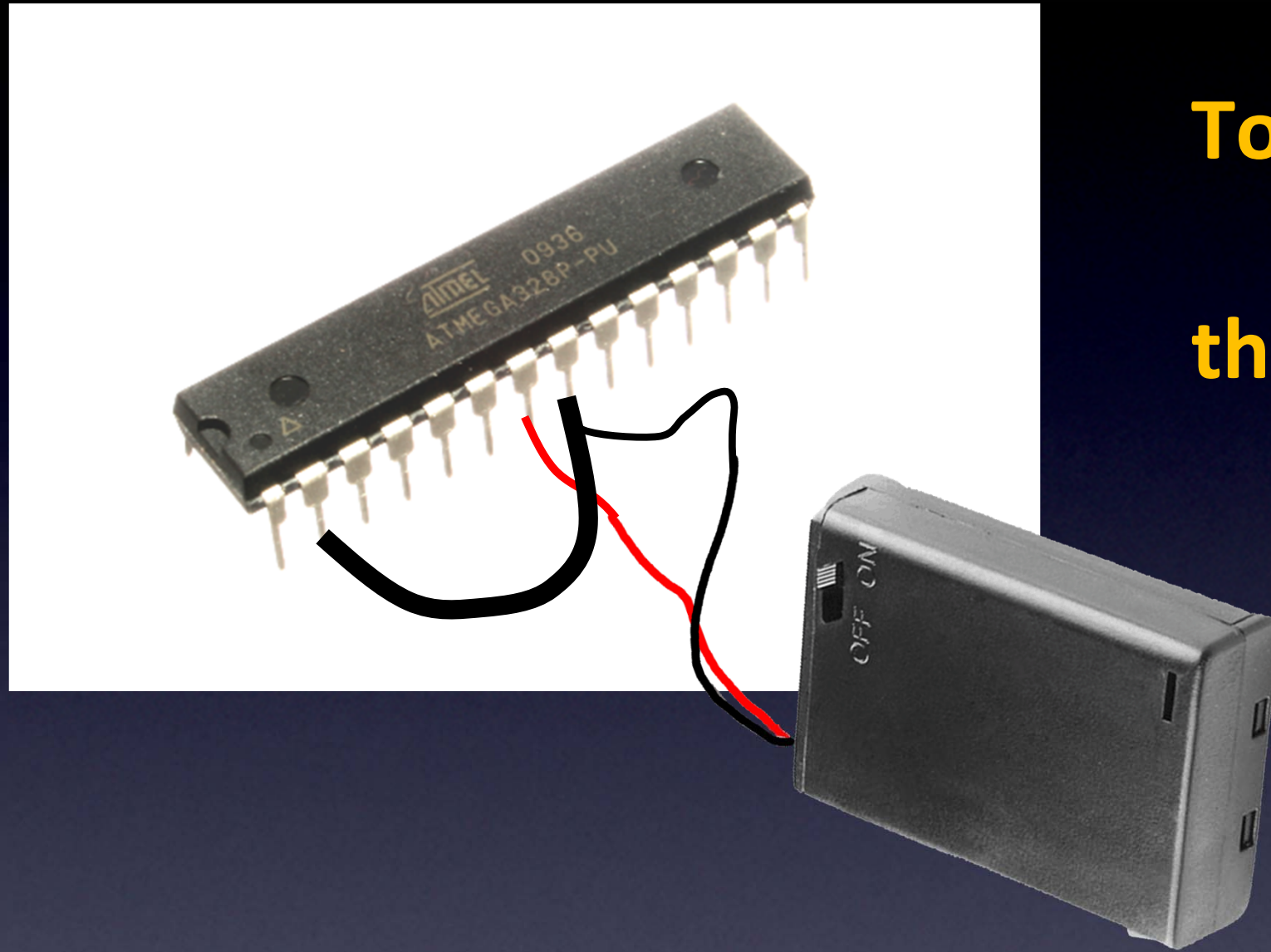

To make the Input pin **Low**, connect it to the **Black** wire of our power supply (**Ground**).

**Low**

Microcontroller – Input pins

# Everything You Need to Know About Electronics

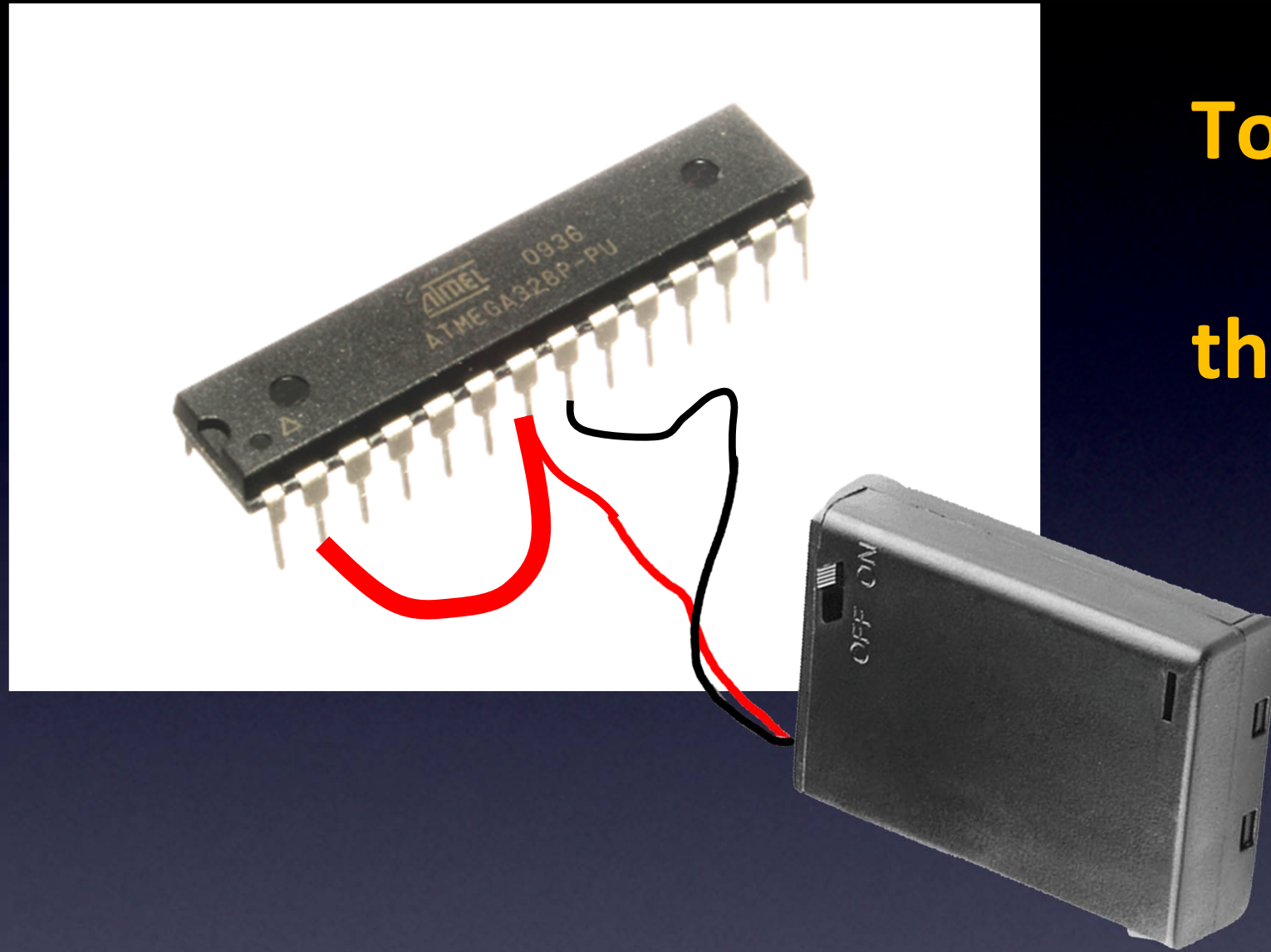

To make the Input pin High, connect it to the Red wire of our power supply (Vcc).

**High**

Microcontroller – Input pins

# Everything You Need to Know About Electronics

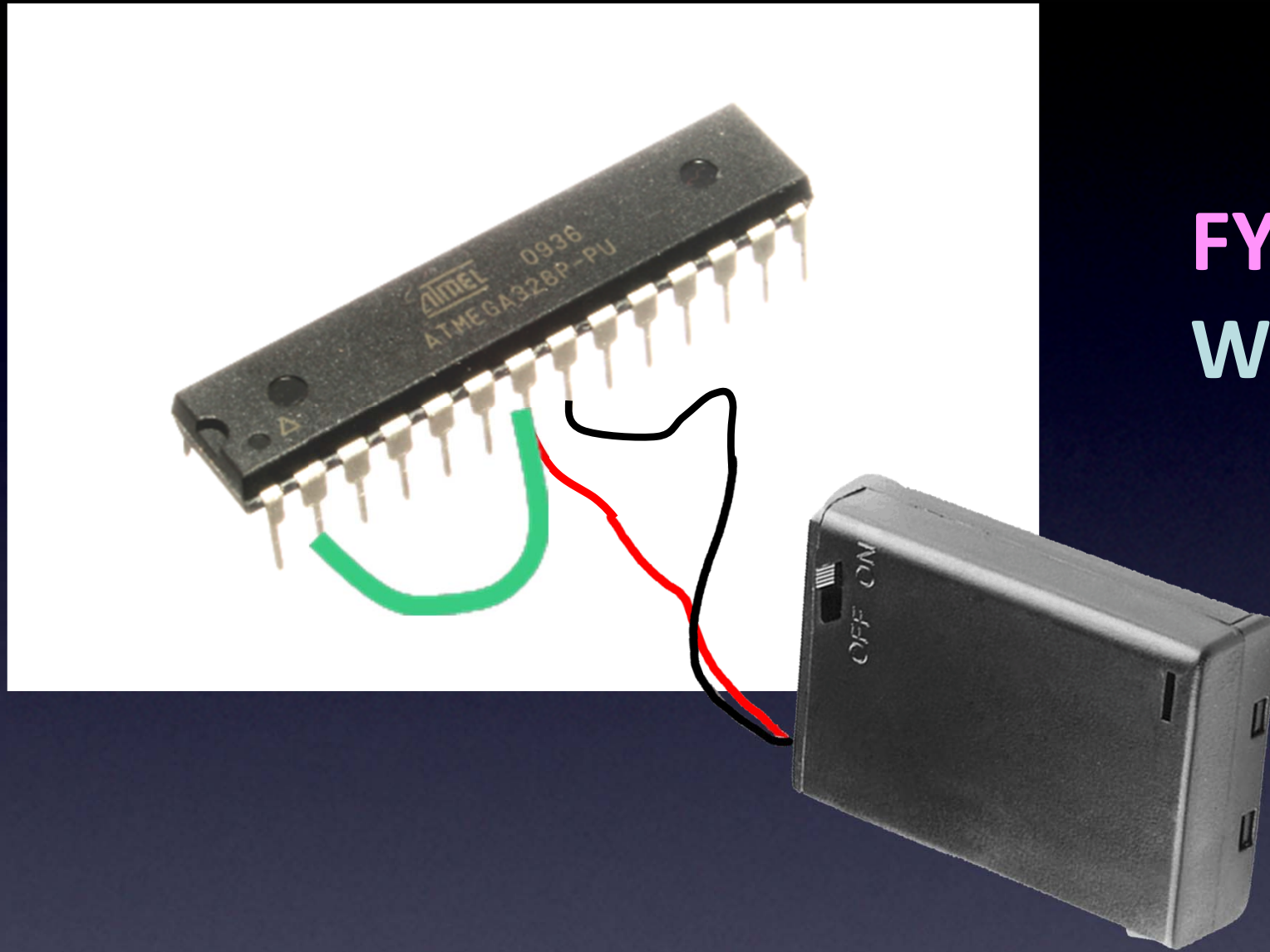

FYI:

Wire color does **not matter** !

(electrons don't care)

**High**

Microcontroller – Input pins

# Everything You Need to Know About Electronics

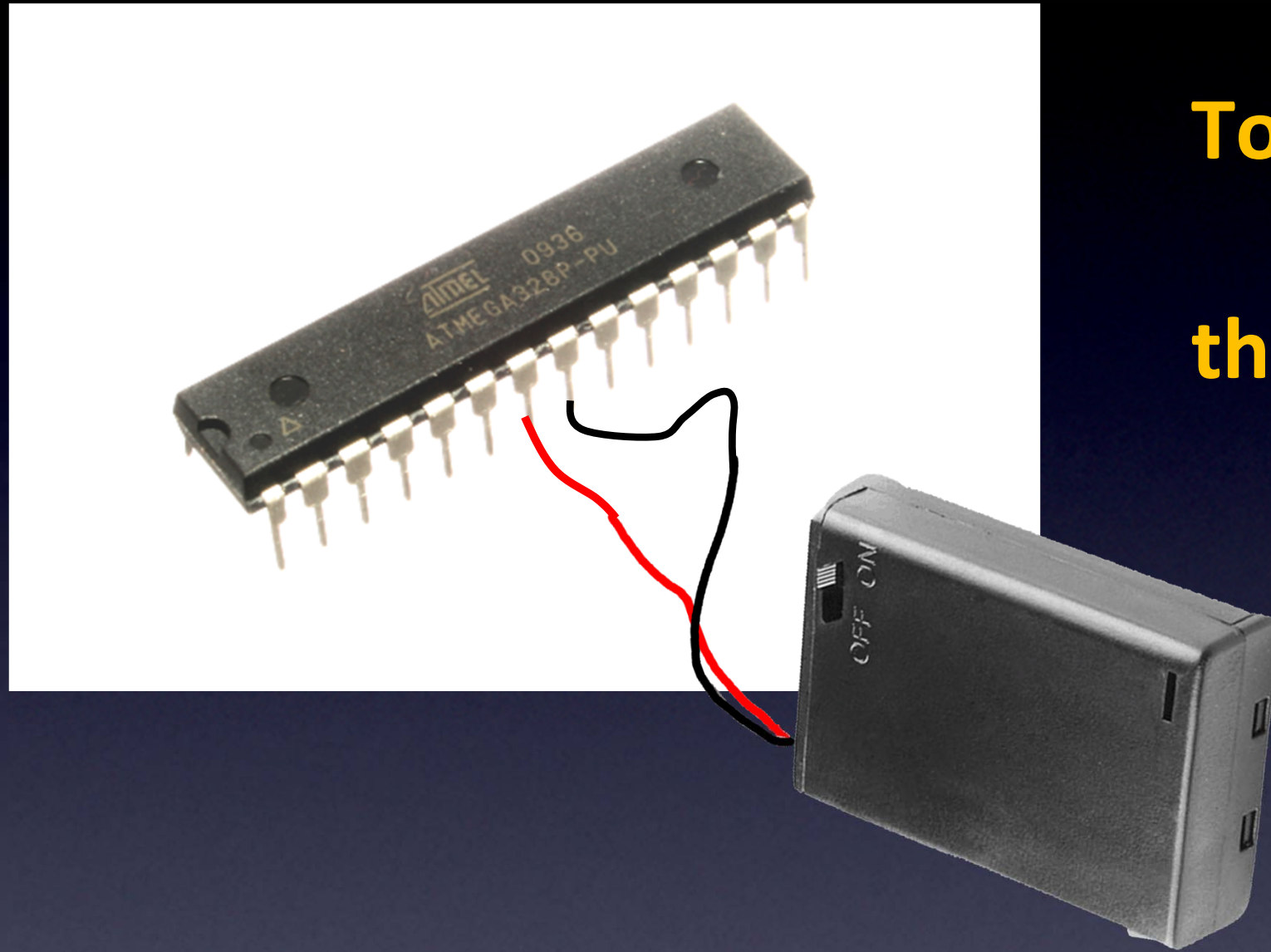

**To make the Input pin High,  
connect it to  
the Red wire of our power  
supply (Vcc).**

**OR:**

**just leave it blank**  
(built-in resistors on each pin)

**High**

Microcontroller – Input pins



# Everything You Need to Know About Electronics

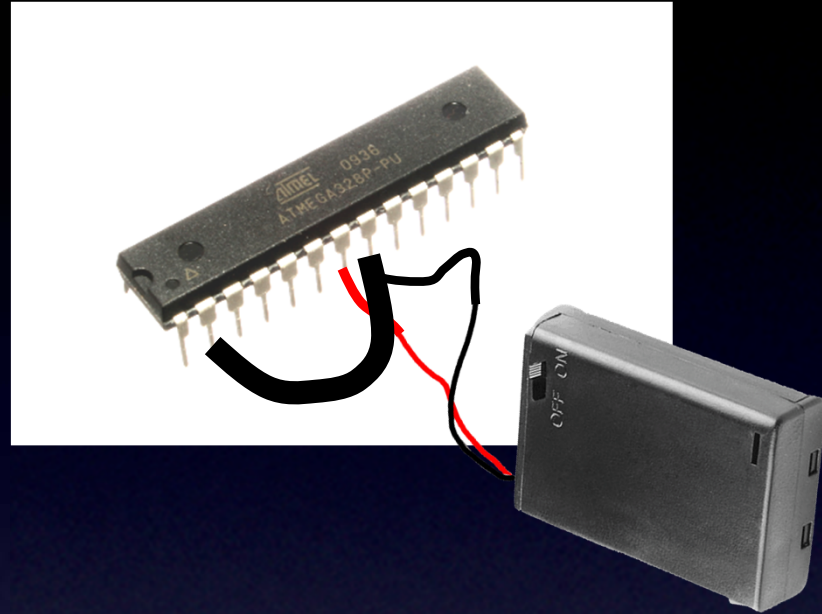

If firmware looks at  
Pin 2 when it's like this,  
it reports back:

**Low**

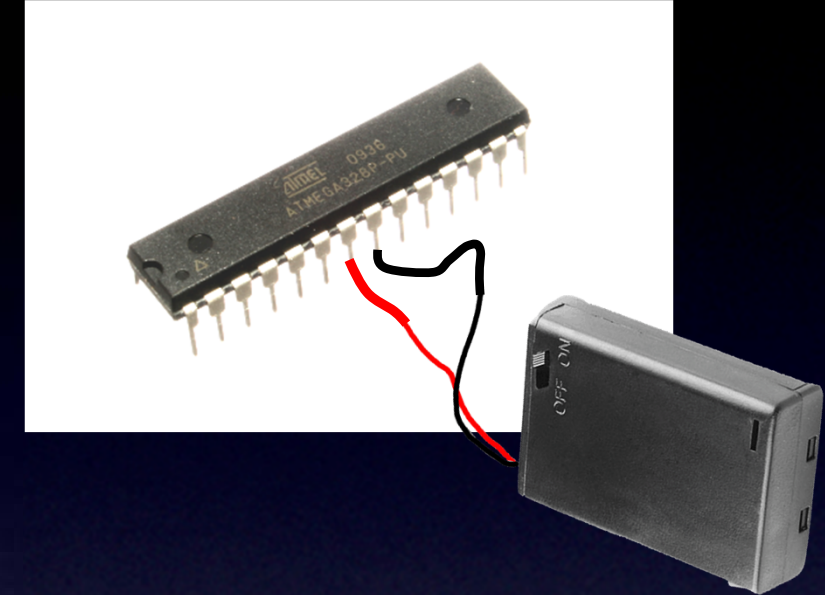

If firmware looks at  
Pin 2 when it's like this,  
it reports back:

**High**

Reading the Input pin

Microcontroller – Input pins

# Everything You Need to Know About Electronics

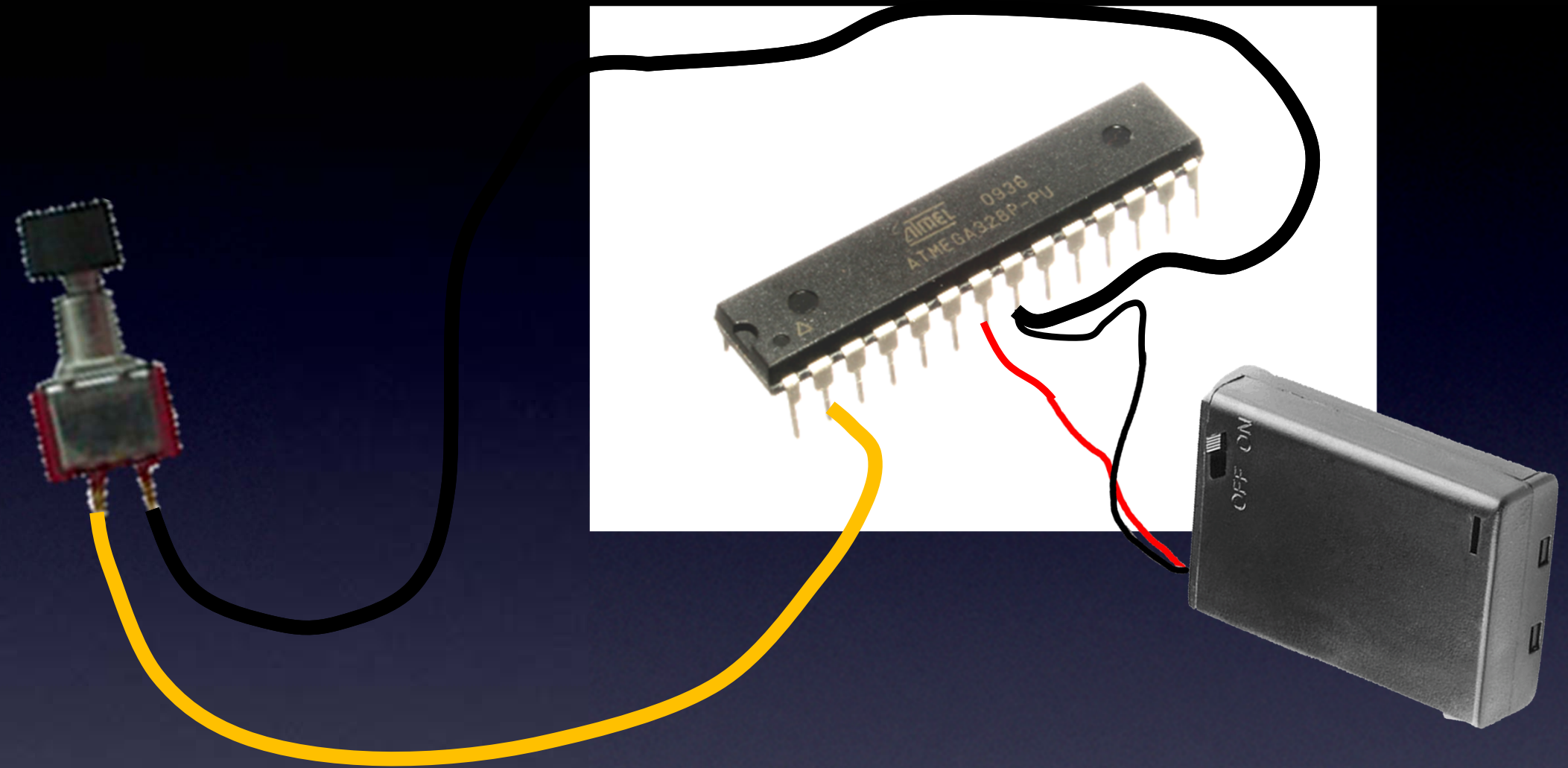

Reading the Input pin, with Switch

Microcontroller – Input pins

# Everything You Need to Know About Electronics

If firmware  
looks at Pin 2  
when switch  
NOT pushed,  
it reports back:  
**High**

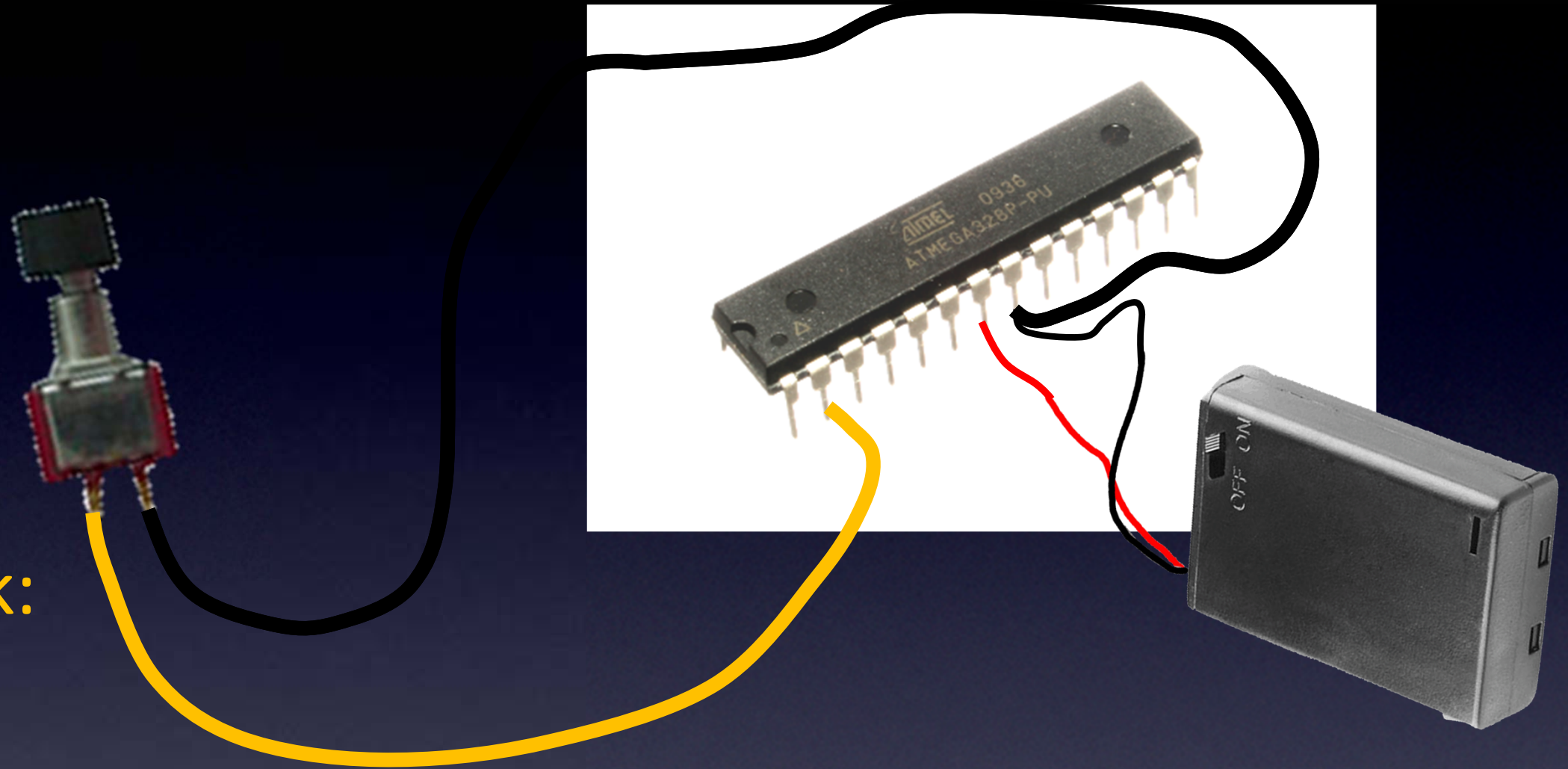

Reading the Input pin, with Switch

Microcontroller – Input pins

# Everything You Need to Know About Electronics

If firmware looks at Pin 2 when switch pushed,  
it reports back:  
**Low**

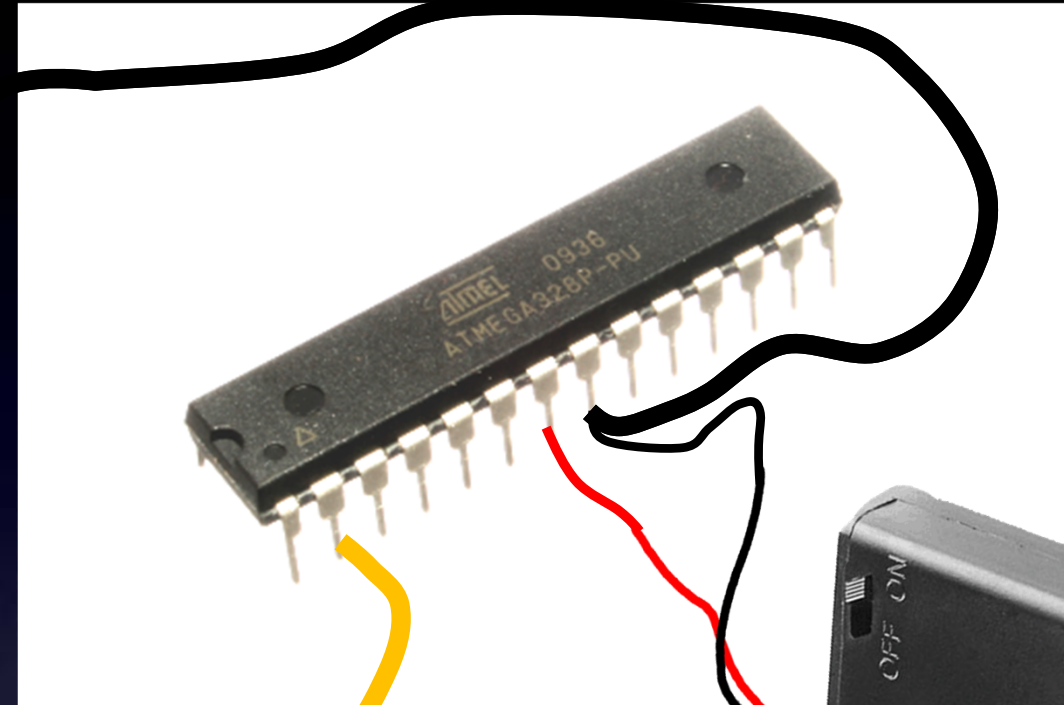

Reading the Input pin, with Switch

Microcontroller – Input pins

# Everything You Need to Know About Electronics

If firmware  
looks at Pin 2  
when switch  
NOT pushed,  
it reports back:  
**High**

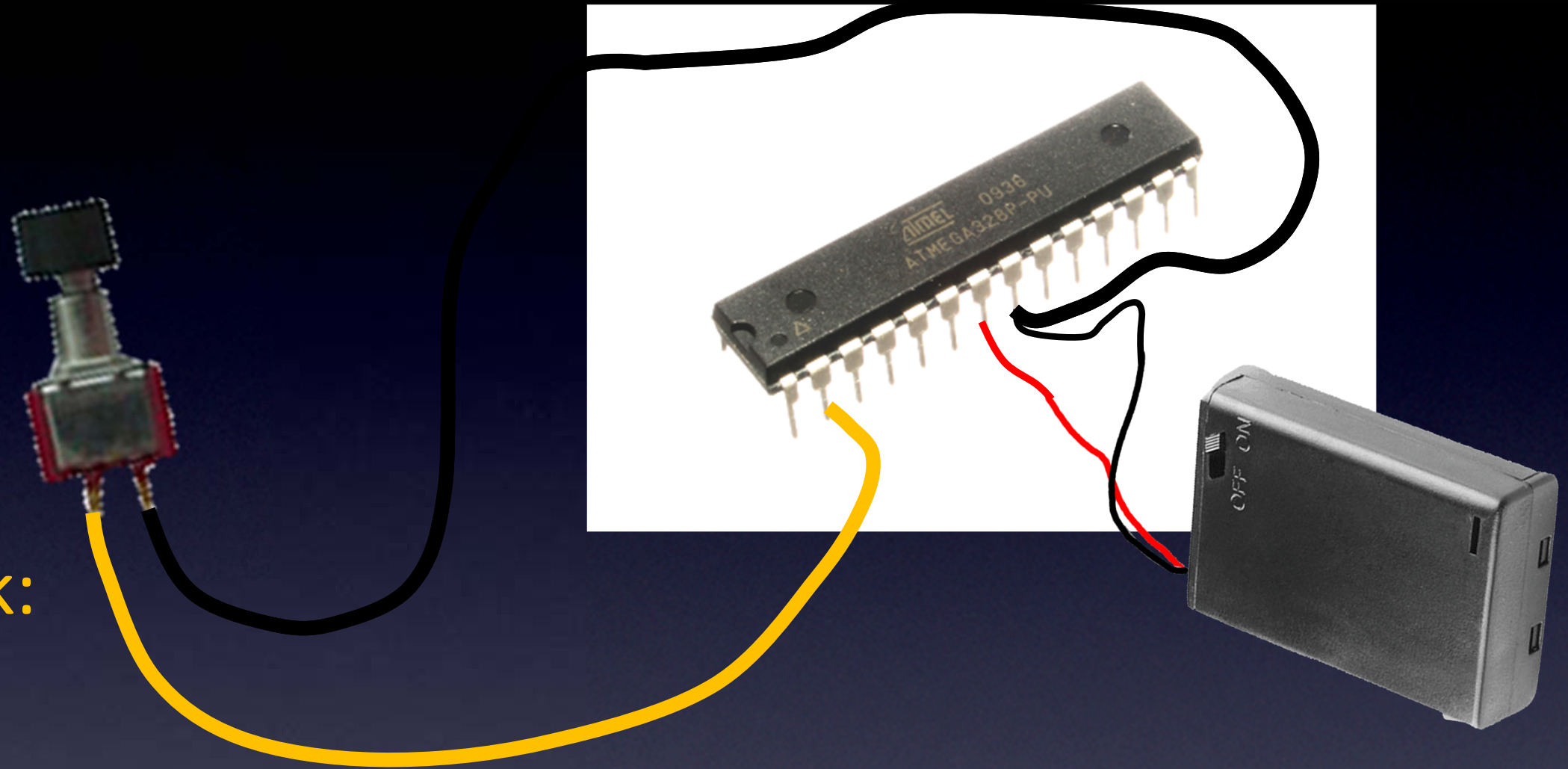

Reading the Input pin, with Switch

Microcontroller – Input pins

# Everything You Need to Know About Electronics

## Hardware

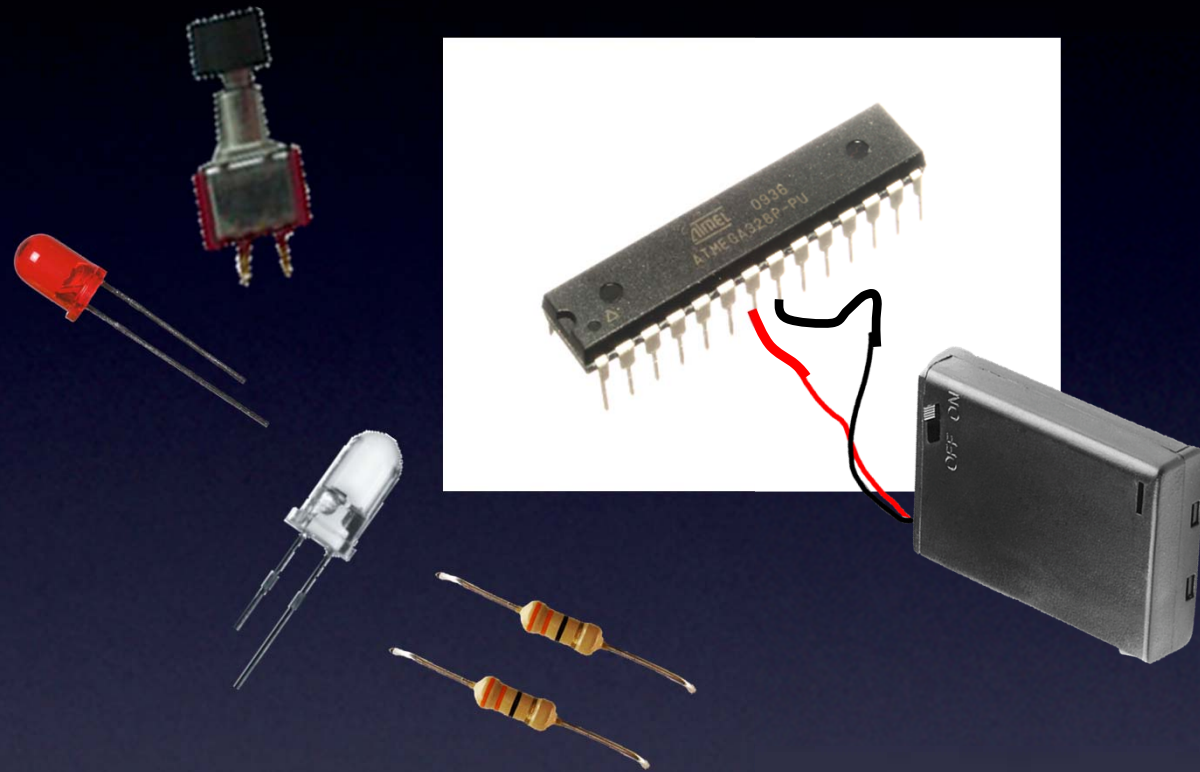

## Firmware

Pin 13 Output – visible LED pin

Pin 3 Output – IR LED pin

Pin 2 Input – Push Button

Wait for Switch to be Low

Blink visible LED:

High, Delay, Low

Pulse IR LED for Sony “OFF” code:

High, Delay, Low, Delay...

Blink visible LED:

High, Delay, Low

Pulse IR LED for Panasonic “OFF” code:

High, Delay, Low, Delay...

Etc for all “OFF” codes

## TV-B-Gone remote control

## Microcontroller

# Everything You Need to Know About Electronics

## Hardware

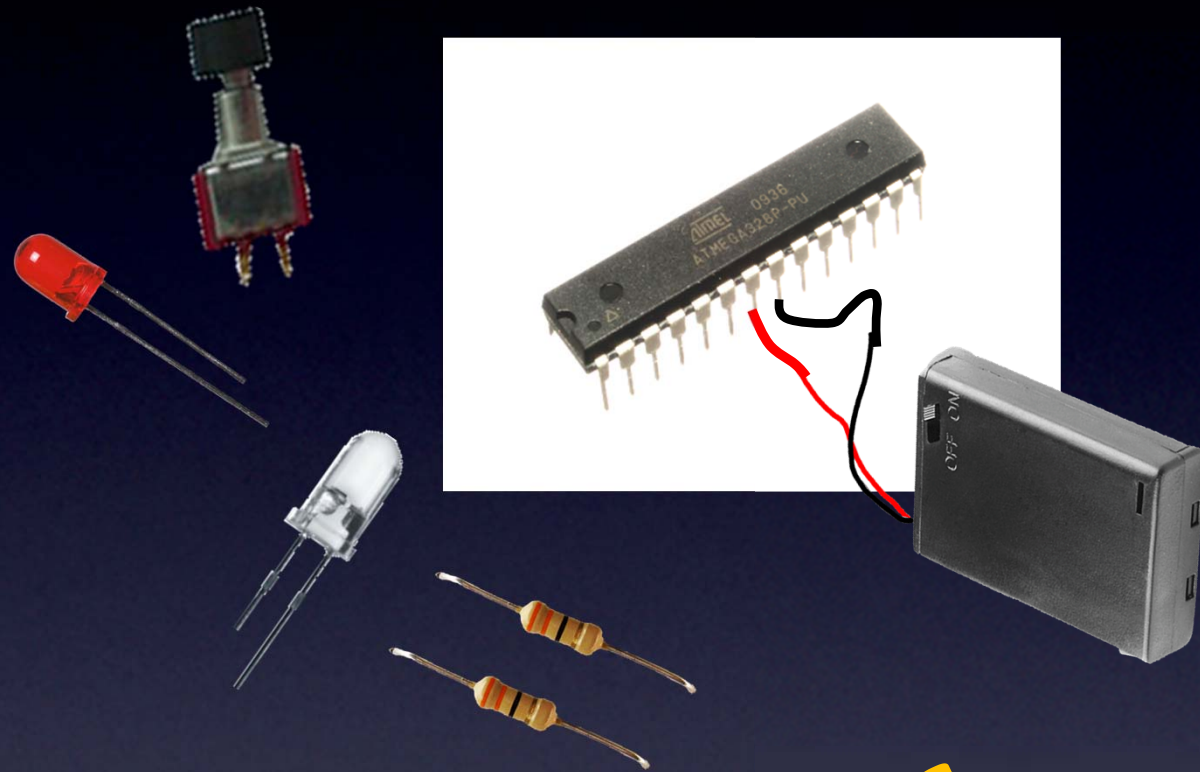

**Except**  
doesn't go very far

## Firmware

Pin 13 Output – visible LED pin

Pin 3 Output – IR LED pin

Pin 2 Input – Push Button

Wait for Switch to be Low

Blink visible LED:

High, Delay, Low

Pulse IR LED for Sony “OFF” code:

High, Delay, Low, Delay...

Blink visible LED:

High, Delay, Low

Pulse IR LED for Panasonic “OFF” code:

High, Delay, Low, Delay...

Etc for all “OFF” codes

## TV-B-Gone remote control

## Microcontroller

# Everything You Need to Know About Electronics

## Review:

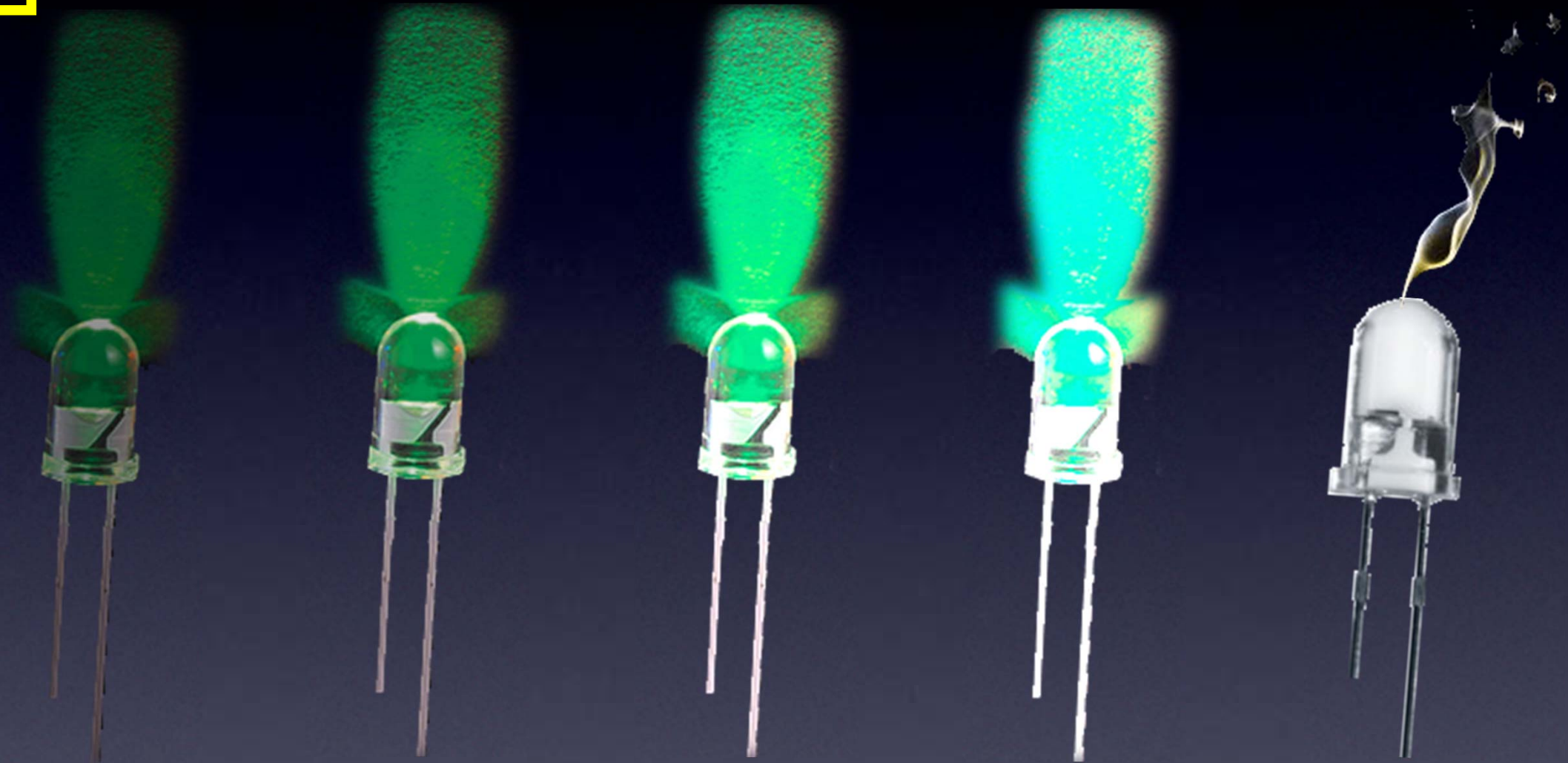

More current  $\rightarrow$  More brightness! (until...)

LED



# Everything You Need to Know About Electronics

Output pin – only 2 choices:

Low

High

Off

On

(0V)

(Power supply voltage

-- *controlled by our Firmware!*)

Output pins

only allow

limited current

(built-in resistors on each pin)



Microcontroller – Output pins

# Everything You Need to Know About Electronics



dimly lit LED

Output pin – only 2 choices:

Low

High

Off

On

(0V)

(Power supply voltage

-- controlled by our Firmware!)

So,  
IR LED  
can only light up  
dimly  
from the Output pin

Output pin – only limited current

Microcontroller – Output pins

# Everything You Need to Know About Electronics

So,  
*let's amplify*  
*the current*  
from the Output pin

with  
a

Current amplifier !

# Everything You Need to Know About Electronics

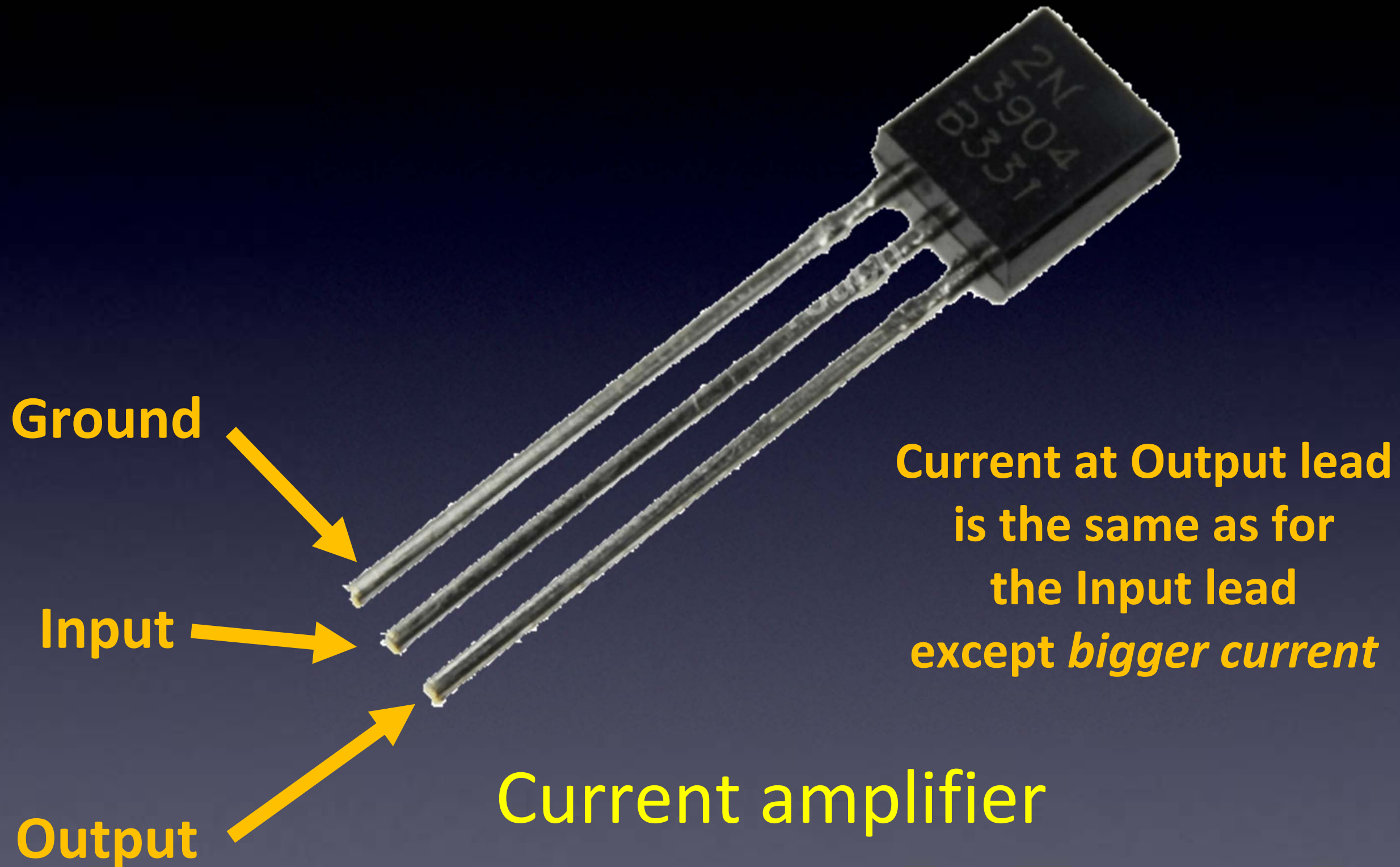

Transistor

# Everything You Need to Know About Electronics

## Hardware

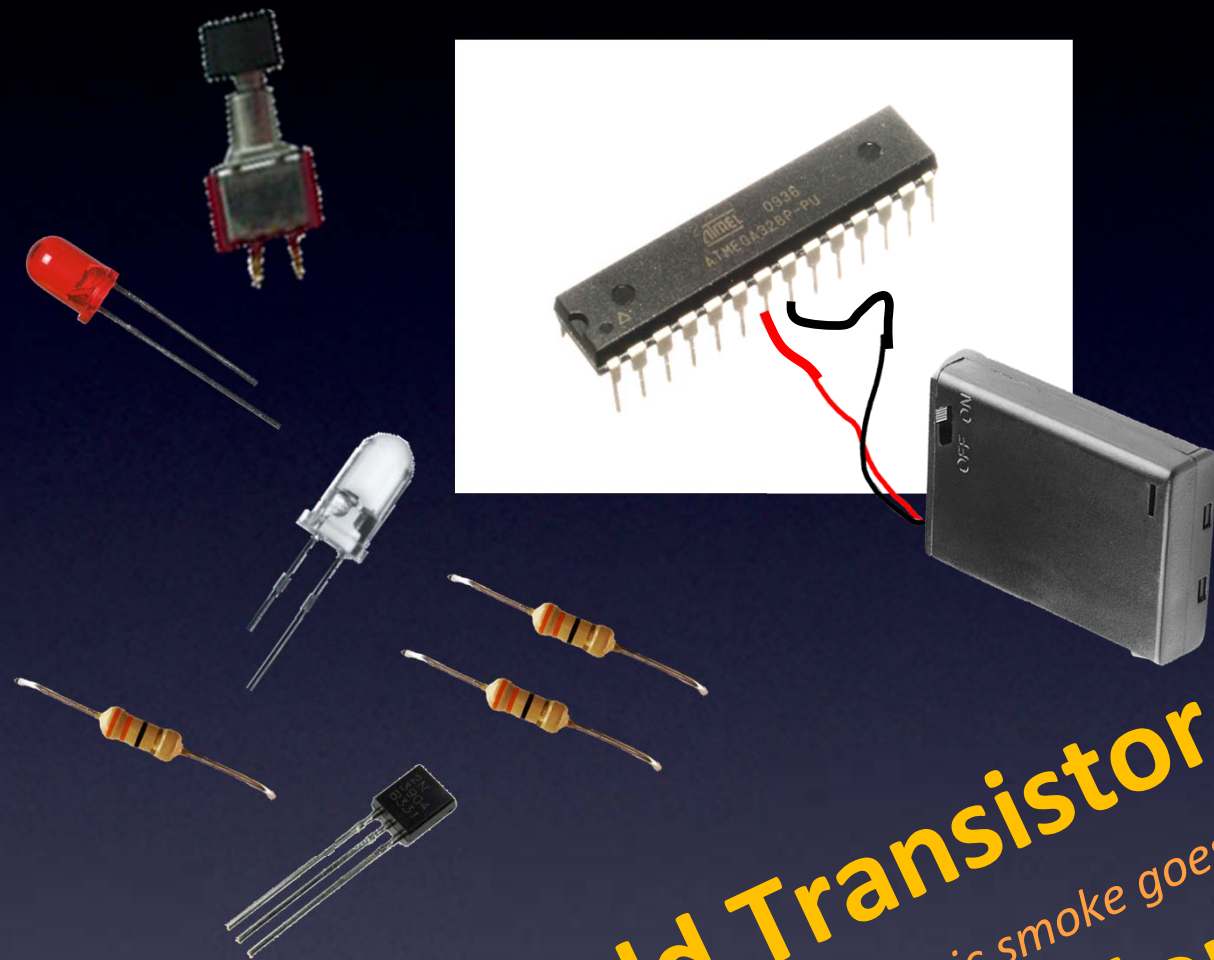

**Add Transistor**  
(and a resistor so no magic smoke goes away)  
**and, we're done!**

## Firmware

Pin 13 Output – visible LED pin

Pin 3 Output – IR LED pin

Pin 2 Input – Push Button

Wait for Switch to be Low

Blink visible LED:

High, Delay, Low

Pulse IR LED for Sony “OFF” code:

High, Delay, Low, Delay...

Blink visible LED:

High, Delay, Low

Pulse IR LED for Panasonic “OFF” code:

High, Delay, Low, Delay...

Etc for all “OFF” codes

**TV-B-Gone remote control – we're done!**

Microcontroller

And, that is

And, that is

*Everything You Need to Know About*  
***Electronics***

Questions?



# Learn To Solder



# **SOLDERING IS EASY**

## HERE'S HOW TO DO IT



BY: **MITCH ALTMAN**  
(SOLDERING WISDOM)

**ANDIE NORDGREN**  
(COMICS ADAPTATION)

**JEFF KEYZER**  
(LAYOUT AND EDITING)

DOWNLOAD THIS COMIC BOOK AND  
SHARE IT WITH YOUR FRIENDS!  
[HTTP://MIGHTYOHM.COM/SOLDERCOMIC](http://mightyohm.com/soldercomic)



DISTRIBUTE WIDELY!

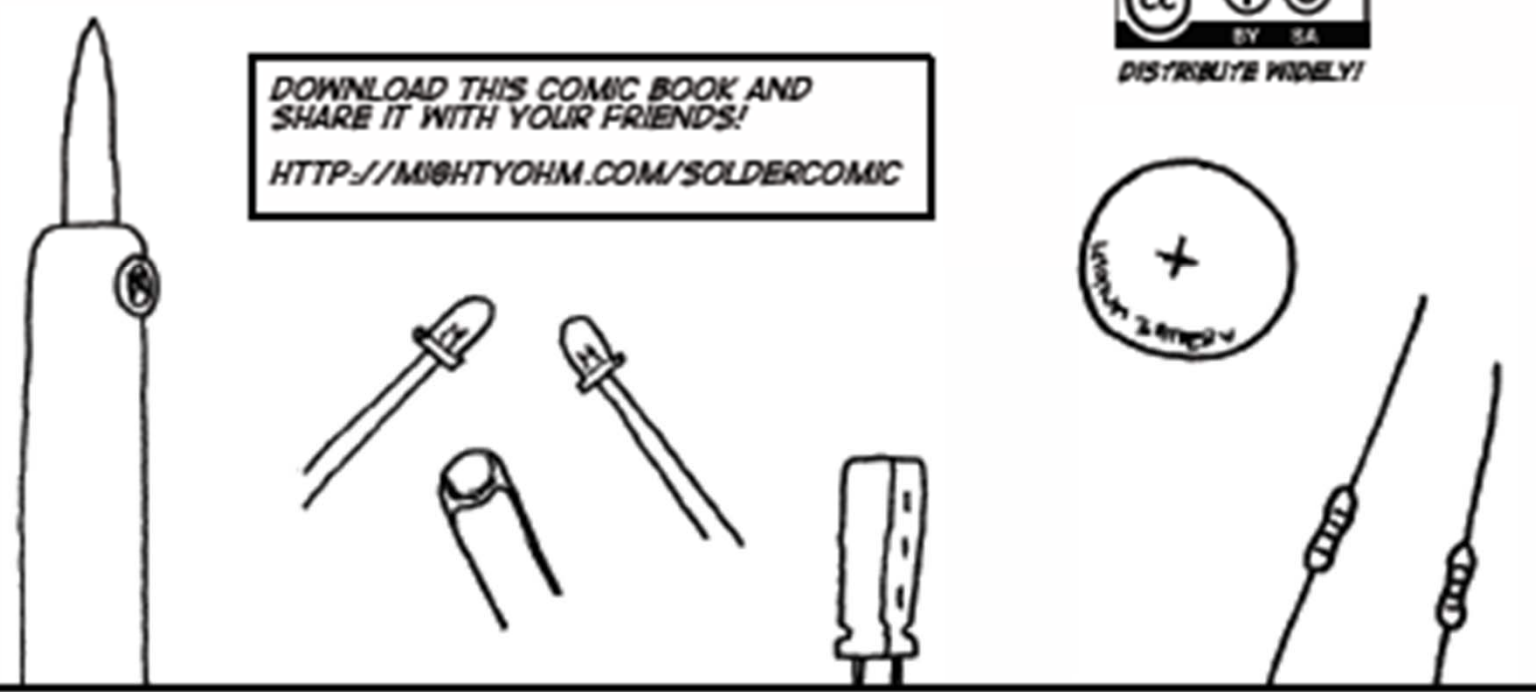

download for free at:  
<http://mightyohm.com/soldercomic>

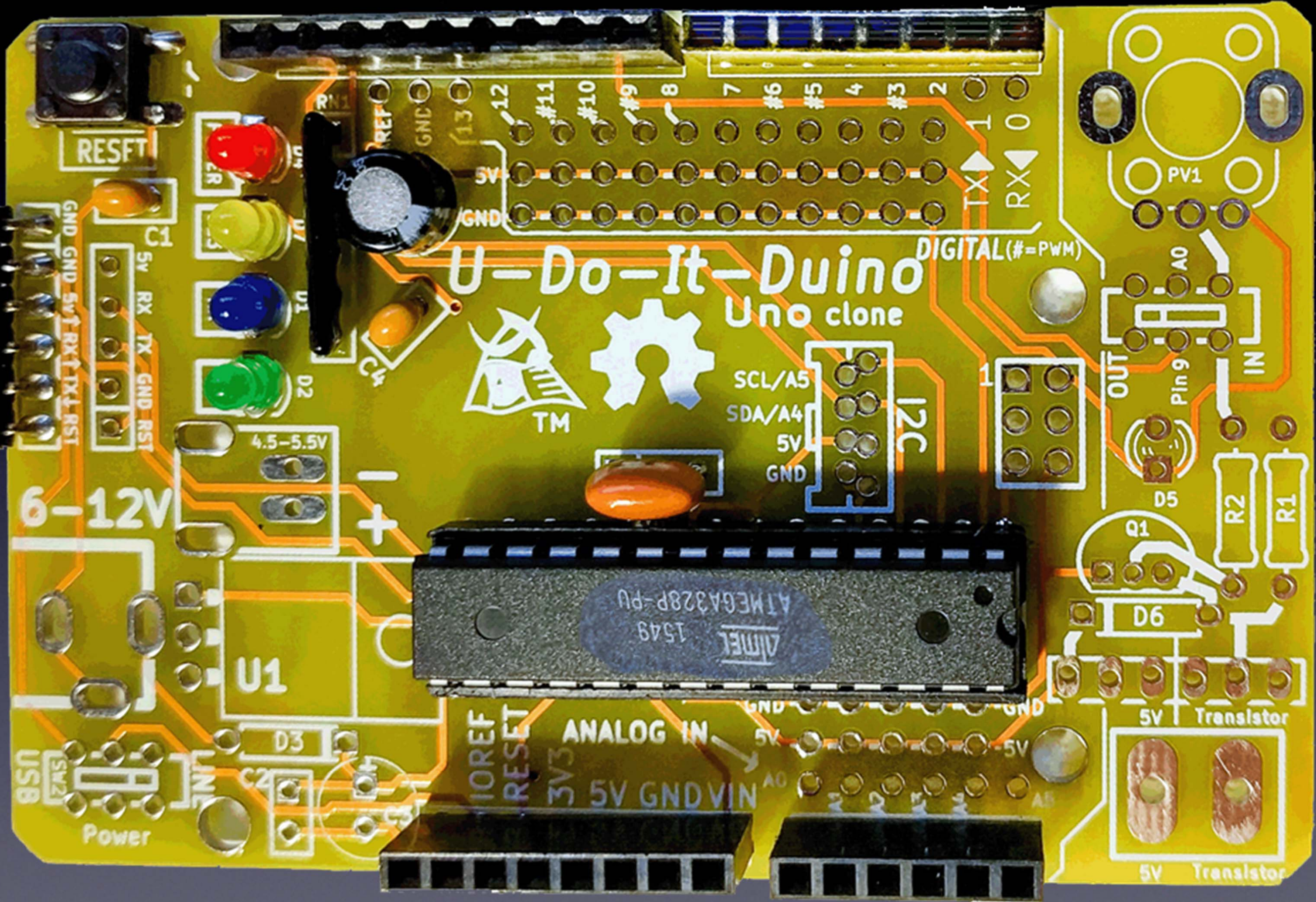

U-Do-It-Duino  
Uno clone



DIGITAL (#=PWM)

6-12V

ANALOG IN

USB

Power

RESFT

I2C

5V Transistor

5V Transistor

SCL/A5  
SDA/A4  
5V  
GND

PV1

A0

OUT

IN

Pin 9

D5

Q1

D6

5V

Transistor

5V

Transistor

RX 0

TX 1

2

#3

#4

#5

#6

7

8

#9

#10

#11

12

GND

5V

REF

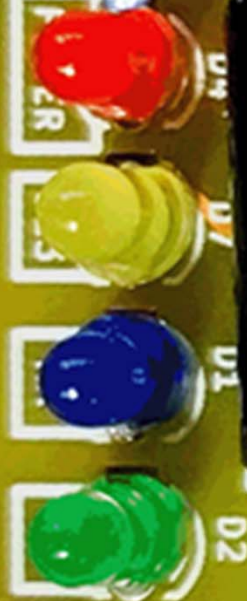

4.5-5.5V

U1

D3

C2

1N4148

5V

5V

RX

TX

GND

RST

GND

5V

RX

TX

GND

RST

GND

5V

RX

TX

GND

RST

5V

RESET

IOREF

A0

A5

5V

GND

5V

GND

5V

GND

1

OUT

IN

D5

Q1

D6

5V

Transistor

5V

Transistor

5V

RESET

IOREF

A0

A5

5V

GND

5V

GND

5V

GND

1

OUT

IN

D5

Q1

D6

5V

Transistor

5V

Transistor

5V

RESET

IOREF

A0

A5

5V

GND

5V

GND

5V

GND

1

OUT

IN

D5

Q1

D6

5V

Transistor

5V

Transistor

5V

RESET

IOREF

A0

A5

5V

GND

5V

GND

5V

GND

1

OUT

IN

D5

Q1

D6

5V

Transistor

5V

Transistor

5V

RESET

IOREF

A0

A5

5V

GND

5V

GND

5V

GND

1

OUT

IN

D5

Q1

D6

5V

Transistor

5V

Transistor

5V

RESET

IOREF

A0

A5

5V

GND

5V

GND

5V

GND

1

OUT

IN

D5

Q1

D6

5V

Transistor

5V

Transistor

5V

RESET

IOREF

A0

A5

5V

GND

5V

GND

5V

GND

1

OUT

IN

D5

Q1

D6

5V

Transistor

5V

Transistor

5V

RESET

IOREF

A0

A5

5V

GND

5V

GND

5V

GND

1

OUT

IN

D5

Q1

D6

5V

Transistor

5V

Transistor

5V

RESET

IOREF

A0

A5

5V

GND

5V

GND

5V

GND

1

OUT

IN

D5

Q1

D6

5V

Transistor

5V

Transistor

5V

RESET

IOREF

A0

A5

5V

GND

5V

GND

5V

GND

1

OUT

IN

D5

Q1

D6

5V

Transistor

5V

Transistor

5V

RESET

IOREF

A0

A5

5V

GND

5V

GND

5V

GND

1

OUT

IN

D5

Q1

D6

5V

Transistor

5V

Transistor

5V

RESET

IOREF

A0

A5

5V

GND

5V

GND

5V

GND

1

OUT

IN

D5

Q1

D6

5V

Transistor

5V

Transistor

5V

RESET

IOREF

A0

A5

5V

GND

5V

GND

5V

GND

1

OUT

IN

D5

Q1

D6

5V

Transistor

5V

Transistor</

# Parts to use

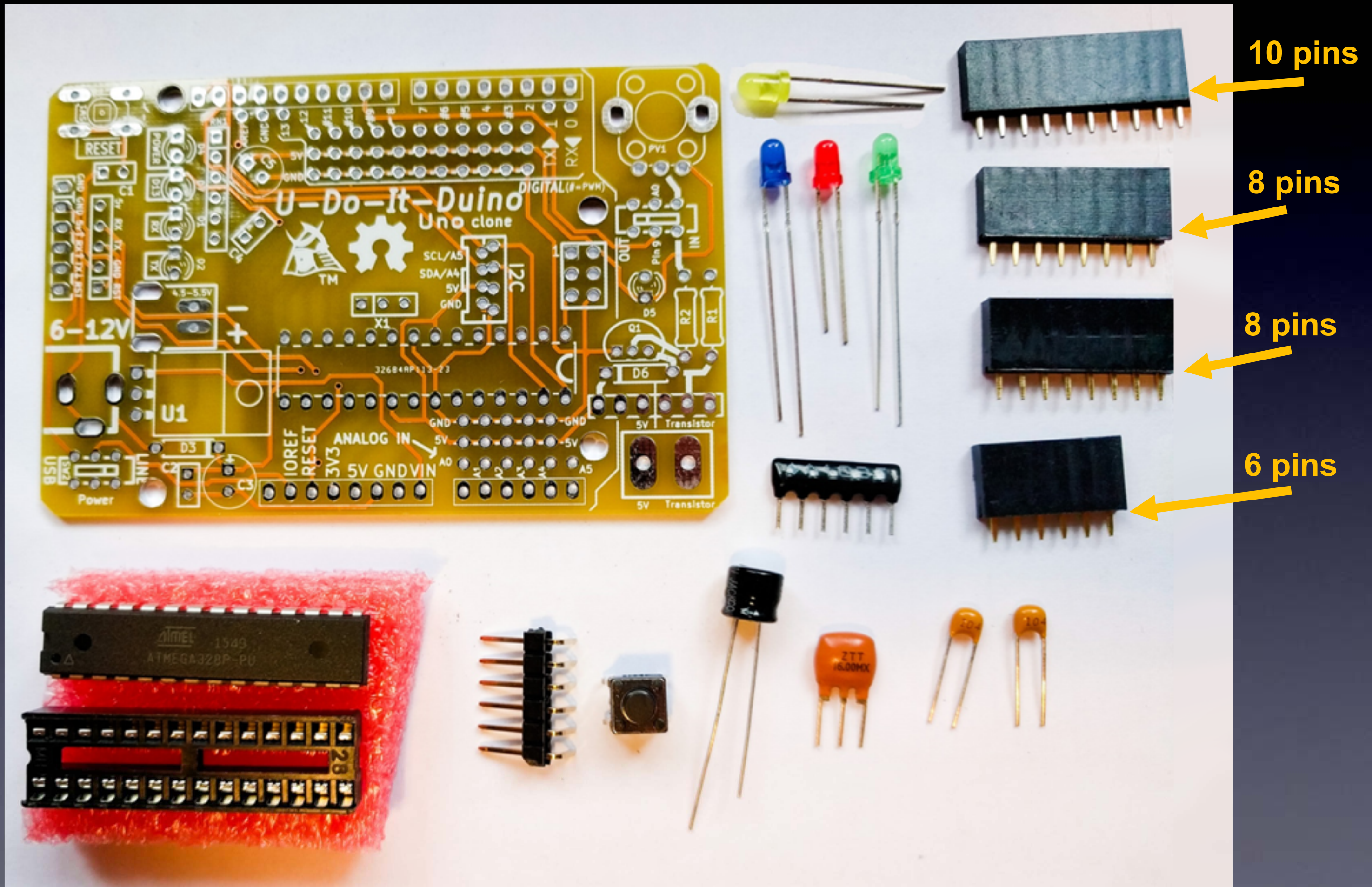

We're done!

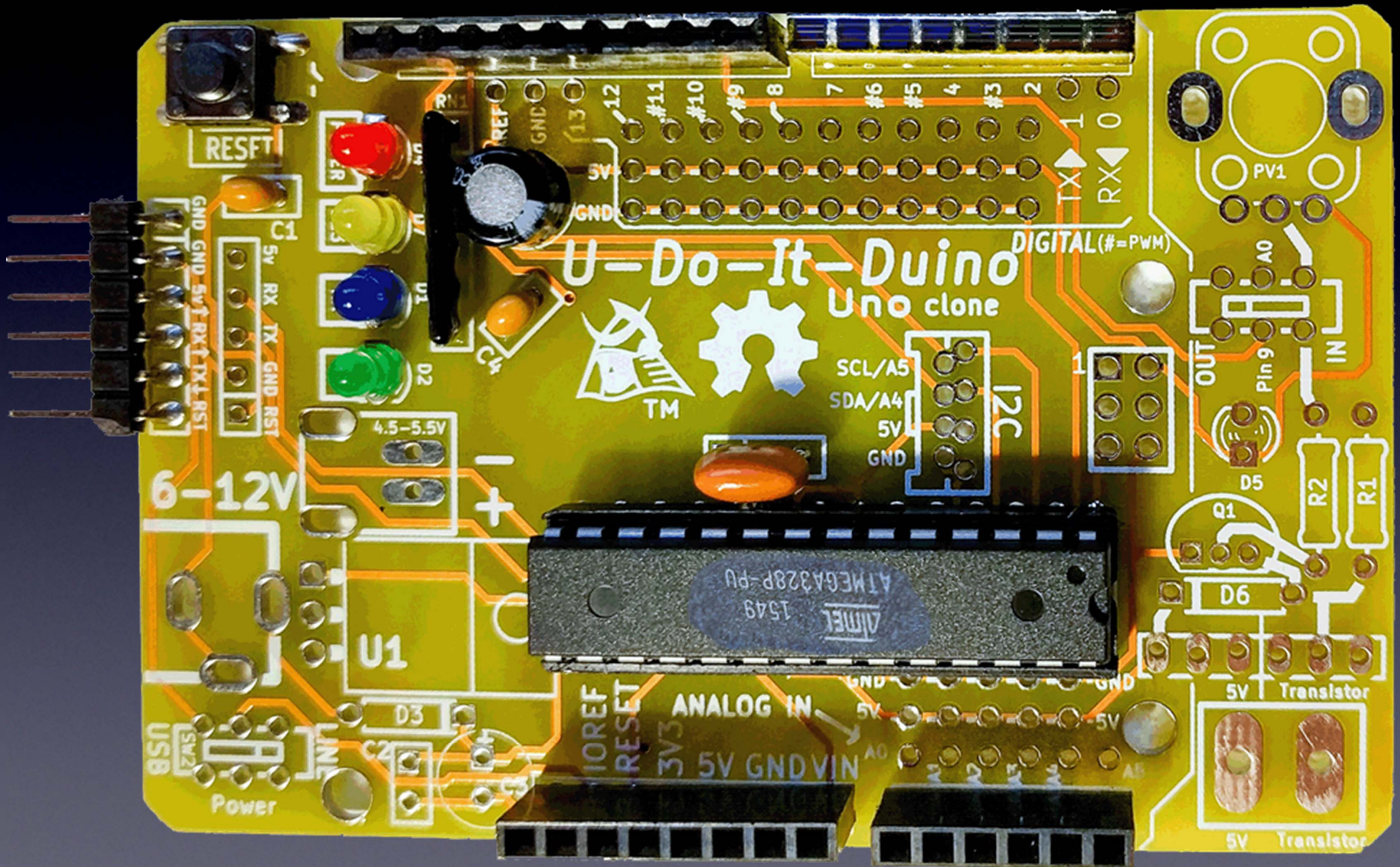

# First test:

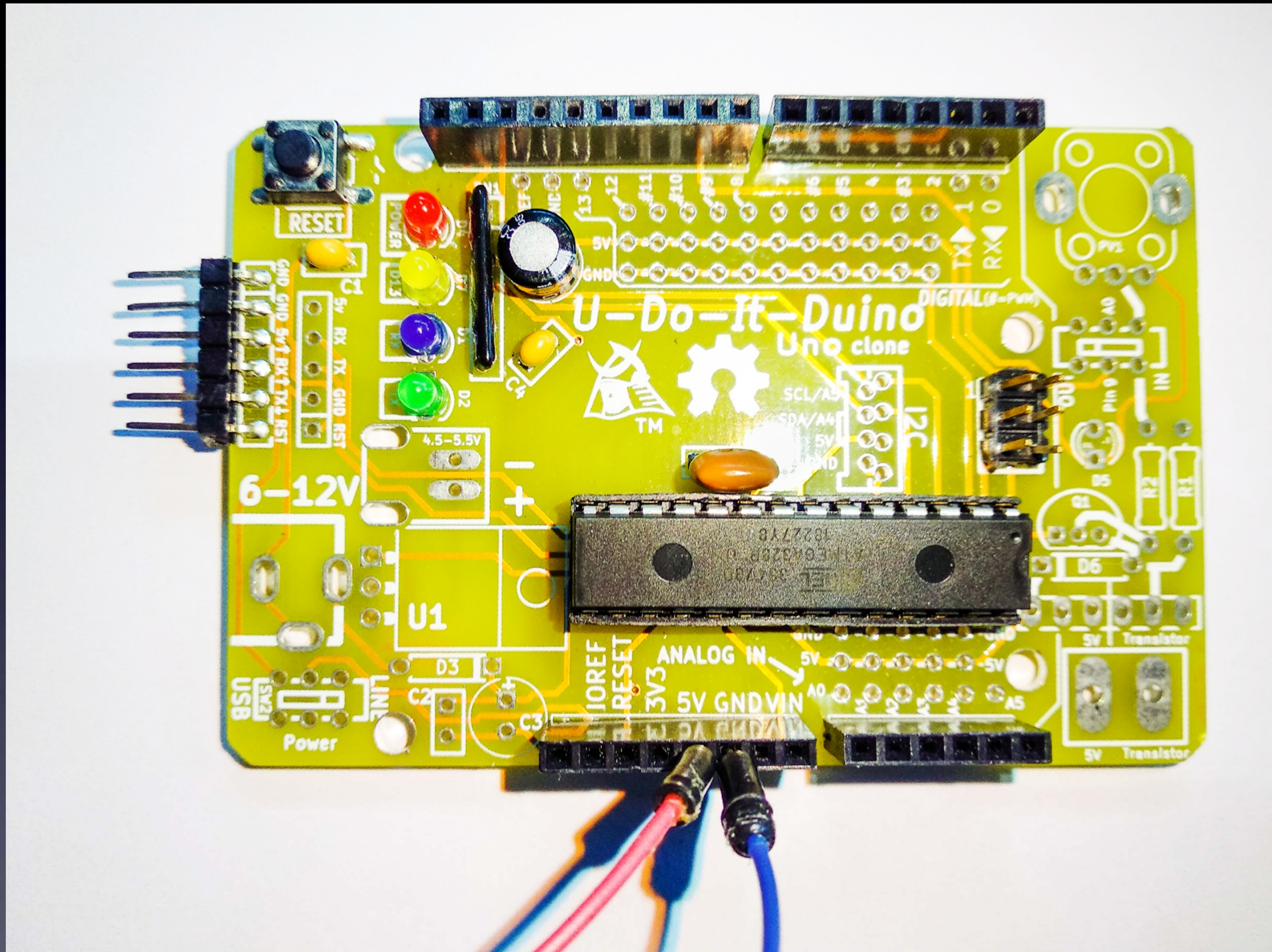

Connect power with a battery pack...

# First test:

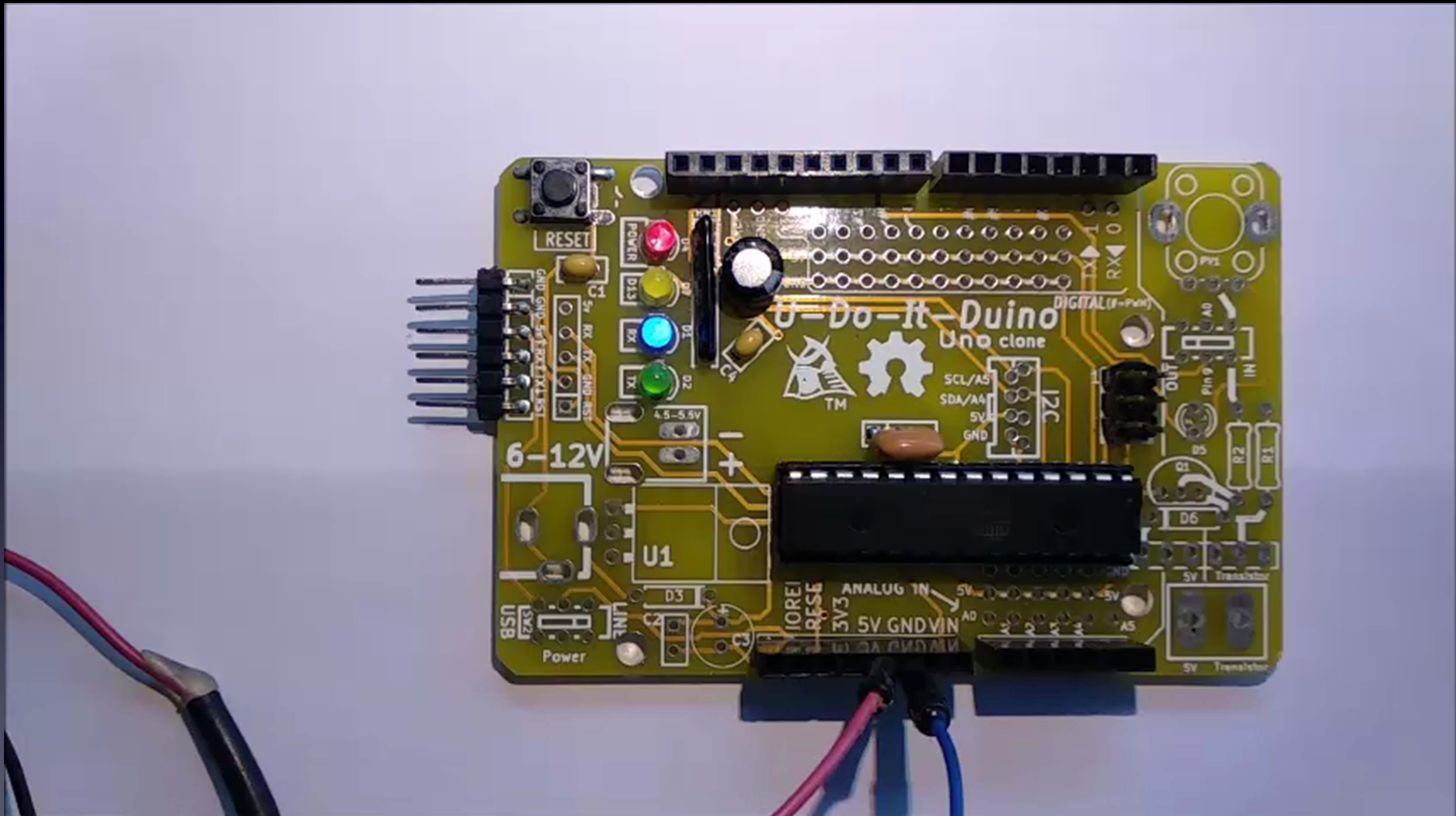

... and it blinks !

Now we can  
connect parts to our Arduino,  
and program it!

# USB-Serial Cable

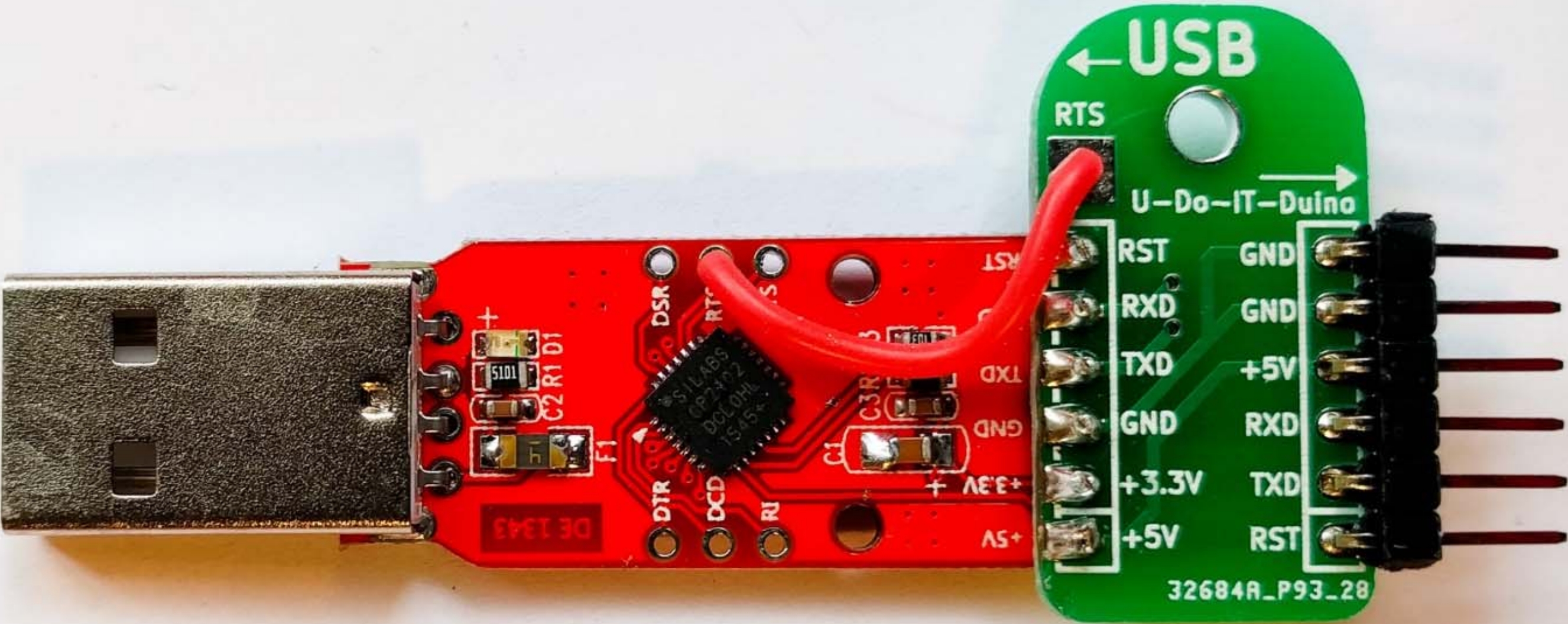



# USB-Serial Cable Driver

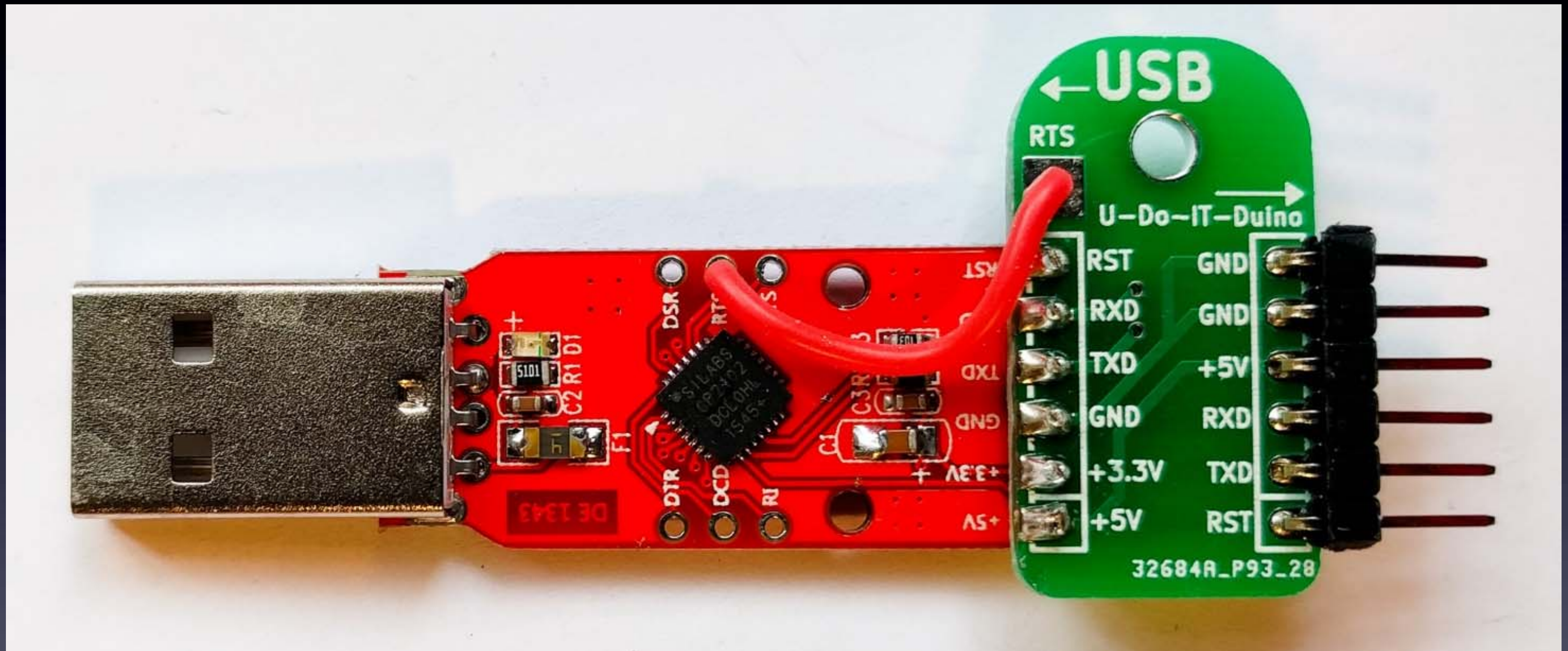

**You will need to download and install a driver  
for your Operating System (Windows, MacOS, or Linux):**

<https://www.silabs.com/products/development-tools/software/usb-to-uart-bridge-vcp-drivers>

*Helpful info*

on the

Ardduino for(4) Total Newbies

---

workshop

web-page:

<http://tiny.cc/A4TN>

# TAKE CONTROL

At Cornfield Electronics we create devices that give people opportunities for effective choices in their lives. Each of us can decide whether to watch TV, and when to watch. Each of us can decide when to get the rest we want, and how we dream. Everyone can learn to make cool things with our kits. Please explore our [products](#), make your own choices, and see how *your* life can be enhanced.

[Join our mailing list](#)



Love it or hate it, TV is all around us. **TV-B-Gone®** universal remote control is the first fruit of our technical savvy, embodying our belief in empowerment, and sense of humor. This universal remote control fits in your pocket and allows you to discreetly turn TVs off or on wherever you go. TV-B-Gone fans around the world are using it for a variety of practical, philosophical, and humorous purposes. Imagine the possibilities...

Years in the making **NeuroDreamer®** sleep mask is the latest of our tools for personal empowerment. We all need rest, but we don't always get it in our

busy lives. Now with the help of NeuroDreamer sleep mask you can use your own brainwaves to bring you the rest you need. And with the lucid dreaming model, you can take control of your dreams. You can enhance your life. The choice is yours.

Want to learn electronics? We make **fun, intriguing, educational, useful kits!** NEW: **ArduTouch music synthesizer kit!**

We make truly useful technological solutions that put you in charge.

Welcome to our better world!

**DO-IT-YOURSELF PROJECTS**  
by Mitch Altman, and friends.  
Last modified: 28-February-2019

**You Can Make Cool Things With Microcontrollers!**

The projects on this page were all created for total beginners, with no experience, to complete successfully at my workshops, or at home, or anywhere!

All you need is a desire, a handful of parts, a soldering iron (with stand and sponge), a wire-cutter, a wire-stripper, solder, and an afternoon.



**Open Hardware!**

Everything on this page (and everything I do) is free and open source!  
(That's *free* as in *freedom*.)  
If you have any questions on anything, please feel free to email me:  
*mitch AT CornfieldElectronics DOT com*



**Soldering!**

Soldering is fun! And it is easy! Really, it is!

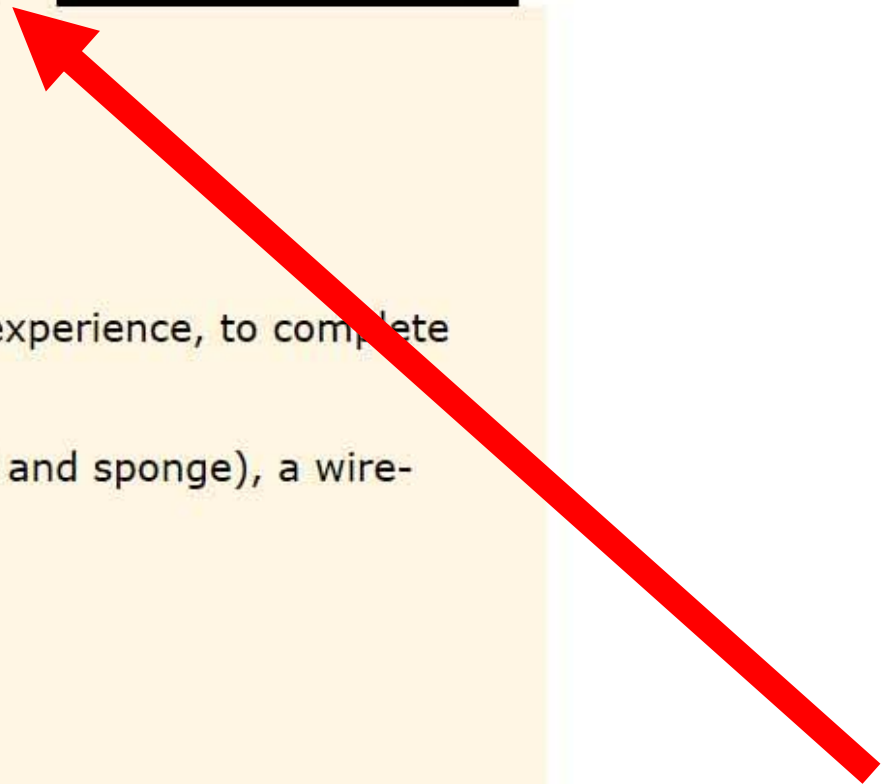



The TV-B-Gone Kit was originally developed from a MiniPOV3 hack (see below) (which, of course, I hacked from my original [TV-B-Gone](#).)

For excellent **assembly instructions**, please go to the [TV-B-Gone Kit page](#) of the of the Adafruit.com website.

For **questions** about the TV-B-Gone Kit, please go to the [TV-B-Gone Kit user forum](#). To see the **schematic, firmware, and board layout**, please go to [TV-B-Gone Kit downloads](#).

TV-B-Gone Kits are available for **purchase** from the [TVBGone.com](#) website.

**Project: Arduino For Total Newbies workshop**  
-- Learn Arduino, and make your own TV-B-Gone!



This workshop covers lots of ground -- all you need to learn how to play with Arduinos. As an example project, you can make your own TV-B-Gone using [Arduino](#). Many thanks to Ken Shirriff for the original [TV-B-Gone for Arduino project](#)! For documentation on this workshop, please see the: [Arduino For Total Newbies Workshop](#) page.

scroll down





The TV-B-Gone Kit was originally developed from a MiniPOV3 hack (see below) (which, of course, I hacked from my original [TV-B-Gone](#).)

For excellent **assembly instructions**, please go to the [TV-B-Gone Kit page](#) of the of the Adafruit.com website.

For **questions** about the TV-B-Gone Kit, please go to the [TV-B-Gone Kit user forum](#). To see the **schematic, firmware, and board layout**, please go to [TV-B-Gone Kit downloads](#).

TV-B-Gone Kits are available for **purchase** from the [TVBGone.com](#) website.

**Project: Arduino For Total Newbies workshop**  
-- Learn Arduino, and make your own TV-B-Gone!



This workshop covers lots of ground -- all you need to learn how to play with Arduinos. As an example project, you can make your own TV-B-Gone using [Arduino](#). Many thanks to Ken Shirriff for the original [TV-B-Gone for Arduino Project!](#) For documentation on this workshop, please see the: [Arduino For Total Newbies Workshop](#) page.

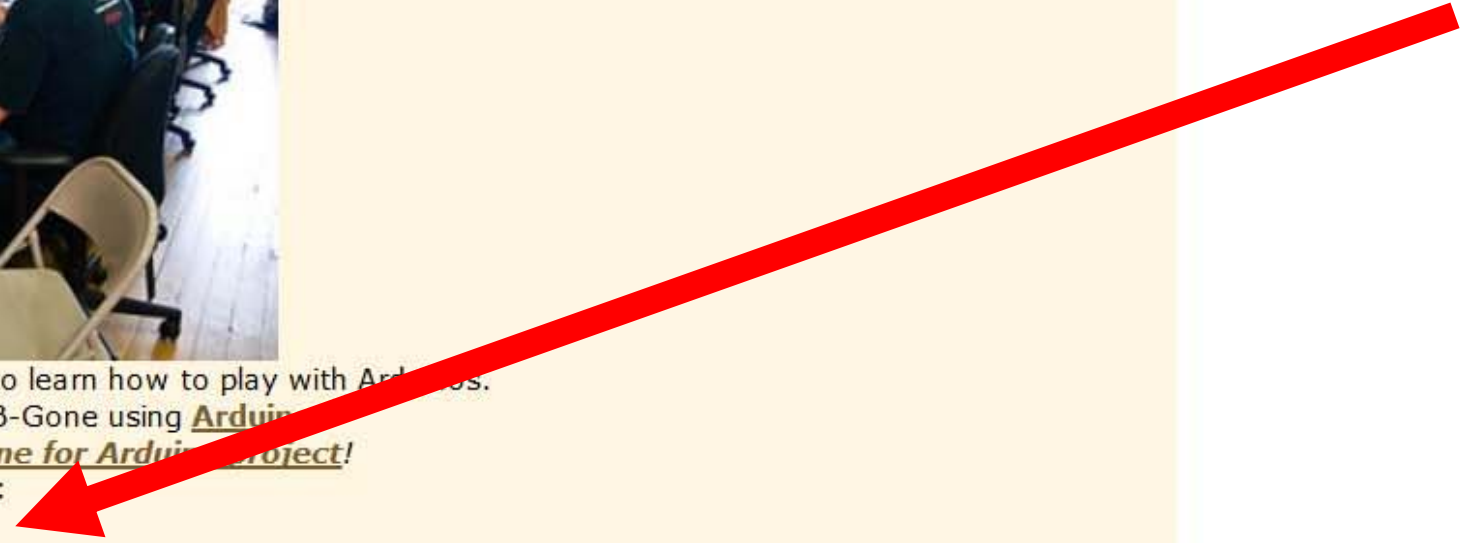



## Arduino For Total Newbies Workshop

*last updated: 5-March-2019*

Learn how to make your own way cool projects with Arduino, using TV-B-Gone as an example project to learn from.



I've given this workshop at [Noisebridge](#) hackerspace in San Francisco (several times), at [27C3](#) and [28C3](#) in Berlin, and [29C3](#), [30C3](#), [31C3](#), [32C3](#), and [33C3](#) in Hamburg, and at [34C3](#) and [35C3](#) in Leipzig, at [CCCamp2011](#) and [CCCamp2015](#) outside of Berlin, at [HeatSync Labs](#) hackerspace in Phoenix, AZ, at [Fabelier](#) hackerspace in Paris, at Unit One in [2012](#), [2014](#), [2016](#), and [2018](#) as Hacker In Residence at the University of Illinois, in Urbana, IL, at Makerspace Urbana in Urbana, IL in [2012](#) and in [2016](#), at [Workshop Weekend](#) in Oakland, CA (twice), at [XinCheJian](#) hackerspace in Shanghai, at [Maker Carnival](#) in Beijing (twice) at several conferences and hackerspaces on my [Hackers on a Train Workshop Tour 2012](#) including at [HOPE Number 9](#) in New York City, at [ToorCamp 2012](#) in Neah Bay, WA, at [OHM 2013](#) and [SHA 2017](#) outside of Amsterdam, at [RockIT CoLabs](#) in San Francisco, at [Balcon2k14](#) in Novi Sad, Serbia, at [HOPE X](#), [The Eleventh HOPE](#), and [The Circle of HOPE](#) in New York City, at [at the iCenter](#) as Hacker In Residence at Tsingua Univeristy in Beijing, at [EMF Camp 2016](#) and [EMF Camp 2018](#) outside of London, at [Tami](#) hackerspace in Tel Aviv, at [Le Wagon](#) in Chendu.

**Here is what is available for downloading for the Arduino For Total Newbies Workshop:**

**1)** You need to download the latest **Arduino software for your computer** (Windows, Mac OS, or Linux):

**[Arduino download page](#)**

**2)** You need a **driver for your USB communications/programming cable**. Several different ones are available. Choose the driver for the cable you have and the operating system for your computer.

**Samurai Circuits board (SiLabs CP210x USB-to-Serial TTL) drivers:**

**[The latest drivers from SiLabs' website](#)**

*The SiLabs driver is installed by default on most Linux systems.*

**Adafruit FTDI Friend drivers:**

**[The latest drivers from FTDI's website](#)**

*The FTDI driver is installed by default on most Linux systems.*

**FTDI Cable drivers:**

**[The latest drivers from FTDI's website](#)**

*The FTDI driver is installed by default on most Linux systems.*

**3)** You also need the **TV-B-Gone Arduino Sketch** (download this, unzip it, and copy it to your computer in the "examples" folder inside your "arduino" folder that you downloaded):

**[TV-B-Gone Arduino sketch\(22KB\)](#)**

**4) Schematic Diagram for Arduino TV-B-Gone remote control:**

**[Schematic Diagram\(449KB\)](#)**

**Parts List for Arduino TV-B-Gone remote control:**

**[Parts List \(Open Office\)\(12KB\)](#)**

**[Parts List \(MS Office\)\(9KB\)](#)**

scroll down





**The latest drivers from FTDI's website**

*The FTDI driver is installed by default on most Linux systems.*

**FTDI Cable drivers:**

**The latest drivers from FTDI's website**

*The FTDI driver is installed by default on most Linux systems.*

**3)** You also need the **TV-B-Gone Arduino Sketch**  
(download this, unzip it, and copy it to your computer in the "examples" folder inside your "arduino" folder that you downloaded):

**[TV-B-Gone Arduino sketch\(22KB\)](#)**

**4) Schematic Diagram for Arduino TV-B-Gone remote control:**

**[Schematic Diagram\(449KB\)](#)**

**Parts List for Arduino TV-B-Gone remote control:**

**[Parts List \(Open Office\)\(12KB\)](#)**

**[Parts List \(MS Office\)\(9KB\)](#)**

**Schematics for the Arduino clone kits:**

**[U-Do-It-Duino schematic \(110KB\)](#)**

**[BoArduino schematic \(40KB\)](#)**

**[Diavolino schematic \(38KB\)](#)**

**Soldering Is Easy comic book:**

**[Solder Comic \(English\) \(809KB\)](#)**

**[Many other languages are available!](#)**

**Here are links to the slides I use in the workshop:**

**[Arduino For Total Newbies workshop slides \(U-Do-It-Duino\) \(38.6MB\)](#)**

**[Arduino For Total Newbies workshop slides \(Diavolino\) \(22.73MB\)](#)**

scroll down

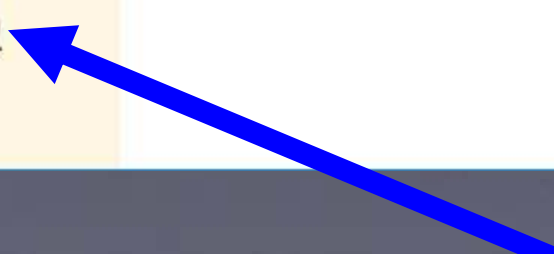
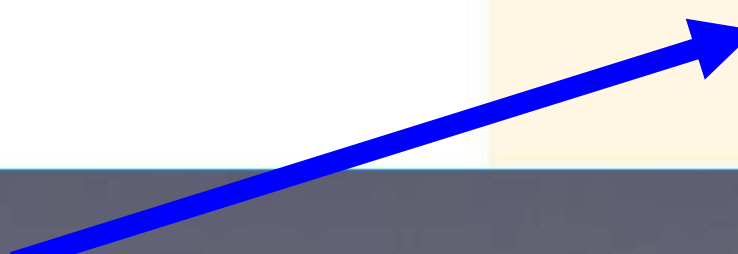

**1)** You need to download the latest **Arduino software for your computer** (Windows, Mac OS, or Linux):

[Arduino download page](#)

The screenshot shows a web browser window with the URL <https://www.arduino.cc/en/Main/Software>. The page features the Arduino logo and a navigation menu with options: HOME, STORE, SOFTWARE (highlighted), EDUCATION, RESOURCES, COMMUNITY, and HELP. A language dropdown menu is set to ENGLISH. The main content area is titled 'SOFTWARE' and features a grid background with a central section for the 'ARDUINO WEB EDITOR'. This section includes a screenshot of the web editor interface showing code for `void setup()` and `void loop()`. Below the screenshot, the text reads: 'Start coding online with the [Arduino Web Editor](#), save your sketches in the cloud, and always have the most up-to-date version of the IDE, including all the contributed libraries and support for new Arduino boards.' To the right of this text are two buttons: 'GETTING STARTED' and 'CODE ONLINE'. At the bottom of the page, there is a section titled 'Download the Arduino IDE' with a teal button that says 'Windows Installer, for Windows XP and up' and another teal button that says 'Windows ZIP file for non admin install'.

**2)** You need a **driver for your USB communications/programming cable.** Several different ones are available. Choose the driver for the cable you have and the operating system for your computer.

**Samurai Circuits board (SiLabs CP210x USB-to-Serial TTL) drivers:**

[The latest drivers from SiLabs' website](#)

*The SiLabs driver is installed by default on most Linux systems.*

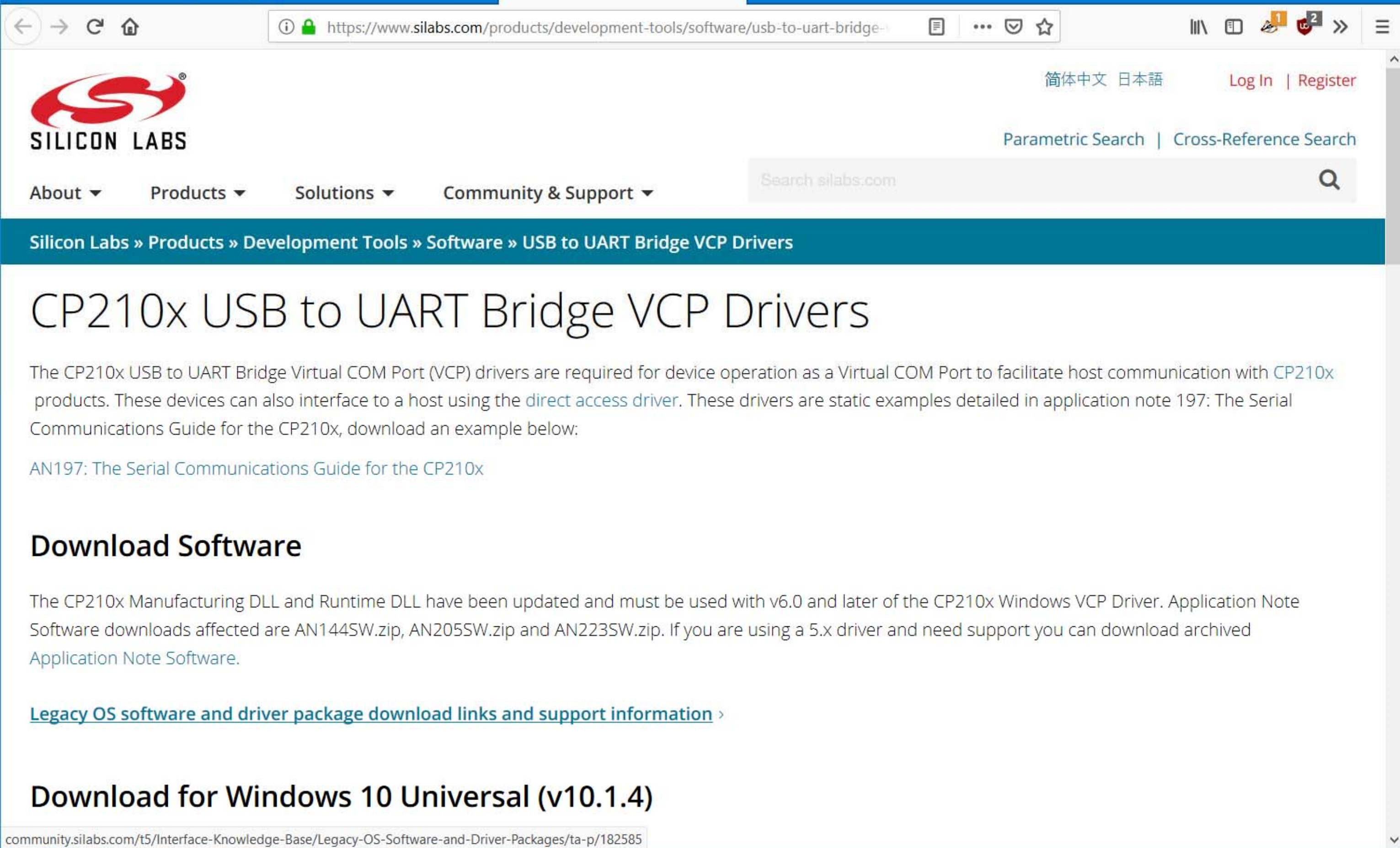

The screenshot shows a web browser window displaying the Silicon Labs website. The address bar shows the URL: <https://www.silabs.com/products/development-tools/software/usb-to-uart-bridge->. The page header includes the Silicon Labs logo, navigation links for About, Products, Solutions, and Community & Support, and a search bar. The main content area features a breadcrumb trail: [Silicon Labs](#) » [Products](#) » [Development Tools](#) » [Software](#) » [USB to UART Bridge VCP Drivers](#). The title of the page is "CP210x USB to UART Bridge VCP Drivers". The text explains that these drivers are required for device operation as a Virtual COM Port to facilitate host communication with CP210x products. It also mentions that these devices can interface to a host using the [direct access driver](#). A link to "AN197: The Serial Communications Guide for the CP210x" is provided. The "Download Software" section states that the CP210x Manufacturing DLL and Runtime DLL have been updated and must be used with v6.0 and later of the CP210x Windows VCP Driver. It lists affected software downloads: AN144SW.zip, AN205SW.zip, and AN223SW.zip. A link to "Legacy OS software and driver package download links and support information" is also present. The page footer shows the URL: [community.silabs.com/t5/Interface-Knowledge-Base/Legacy-OS-Software-and-Driver-Packages/ta-p/182585](https://community.silabs.com/t5/Interface-Knowledge-Base/Legacy-OS-Software-and-Driver-Packages/ta-p/182585).

# CP210x USB to UART Bridge VCP Drivers

The CP210x USB to UART Bridge Virtual COM Port (VCP) drivers are required for device operation as a Virtual COM Port to facilitate host communication with CP210x products. These devices can also interface to a host using the [direct access driver](#). These drivers are static examples detailed in application note 197: The Serial Communications Guide for the CP210x, download an example below:

[AN197: The Serial Communications Guide for the CP210x](#)

## Download Software

The CP210x Manufacturing DLL and Runtime DLL have been updated and must be used with v6.0 and later of the CP210x Windows VCP Driver. Application Note Software downloads affected are AN144SW.zip, AN205SW.zip and AN223SW.zip. If you are using a 5.x driver and need support you can download archived [Application Note Software](#).

[Legacy OS software and driver package download links and support information](#) >

## Download for Windows 10 Universal (v10.1.4)

**3)** You also need the **TV-B-Gone Arduino Sketch** (download this, unzip it, and copy it to your computer in the "examples" folder inside your "arduino" folder that you downloaded):

**[TV-B-Gone Arduino sketch\(22KB\)](#)**

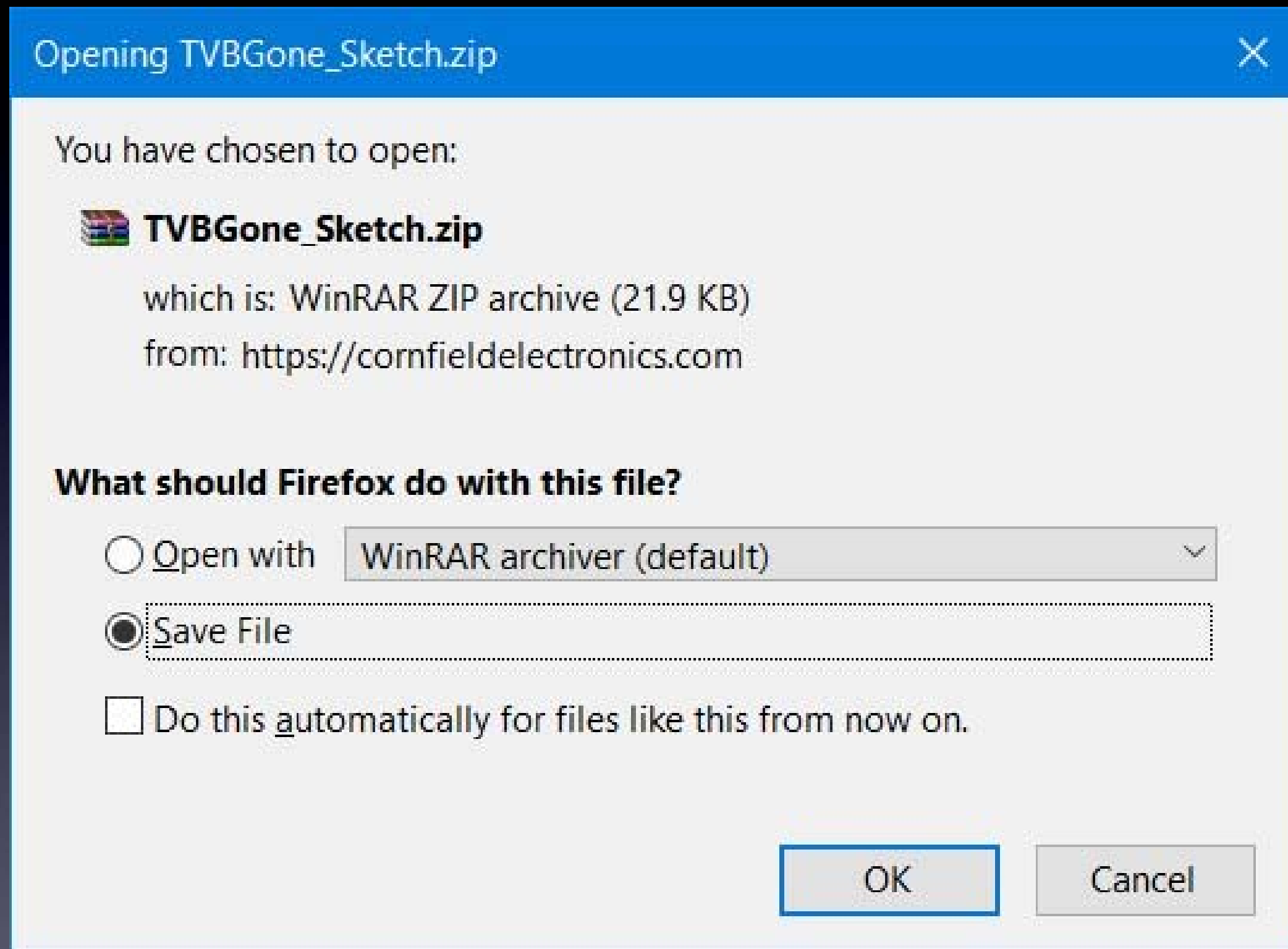

## 4) Schematic Diagram for Arduino TV-B-Gone remote control: Schematic Diagram(449KB)

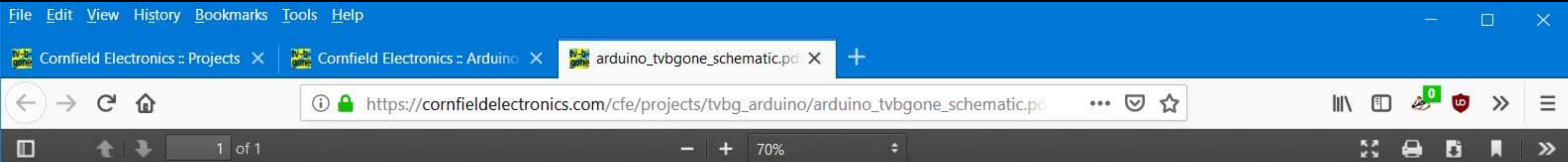

### Arduino For Total Newbies

4-Sep-2015

Mitch Altman (original TV-B-Gone hardware and firmware, modified TV-B-Gone Arduino design)  
Limore Fried (firmware modifications, kit design)  
Ken Shirriff (original modifications for Arduino)  
Johannes Schneemann (documentation)

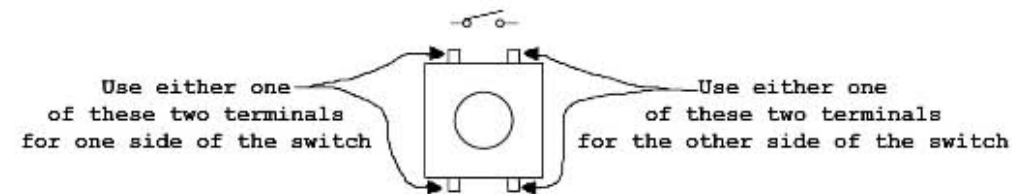
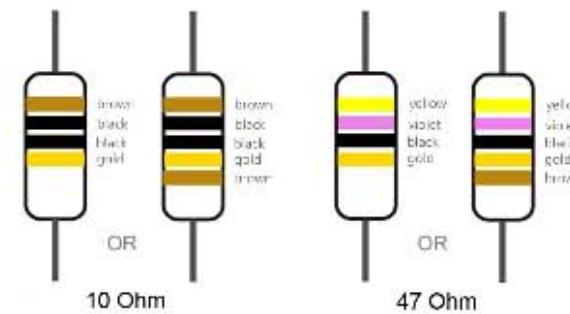
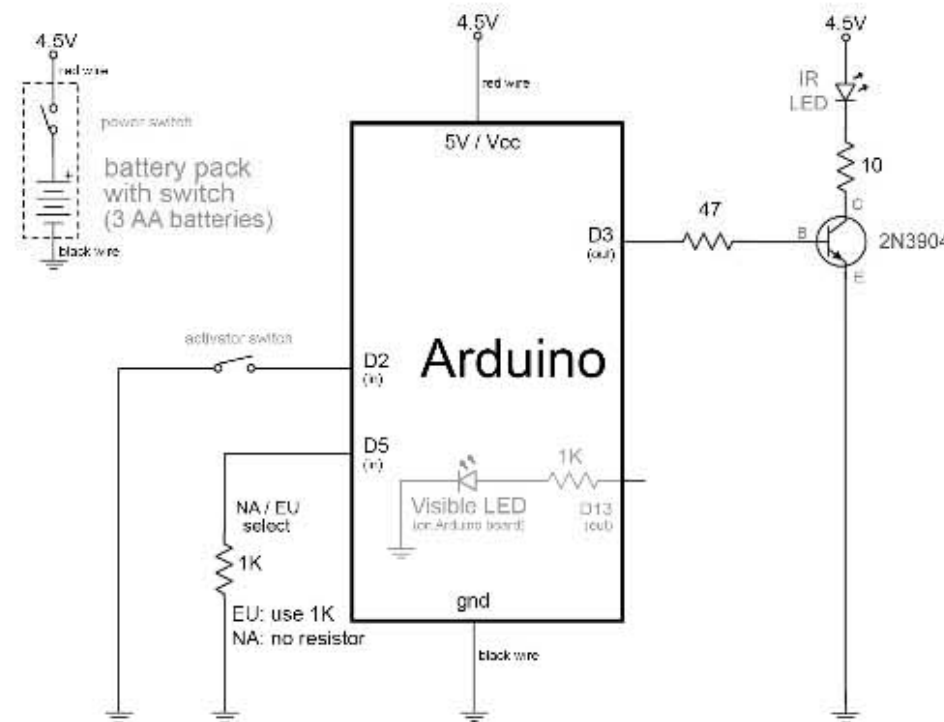

# USB-Serial Cable

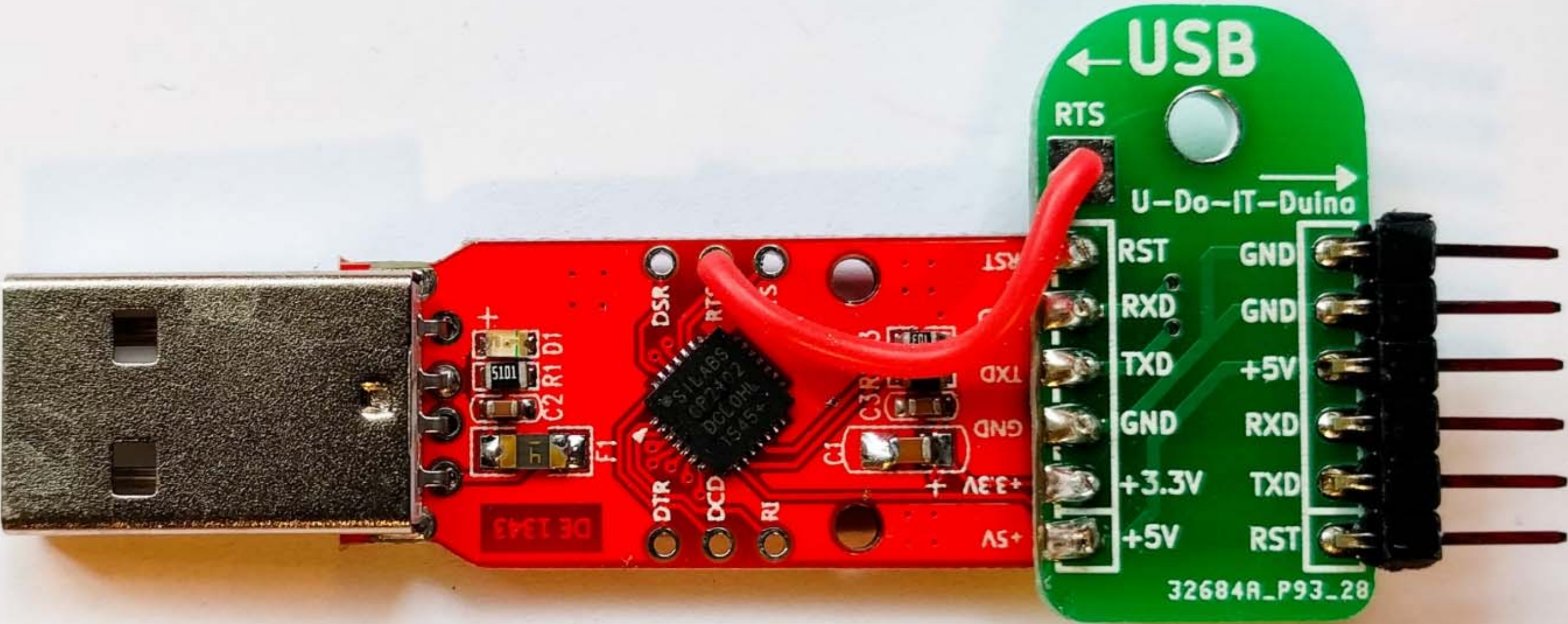

To computer's USB

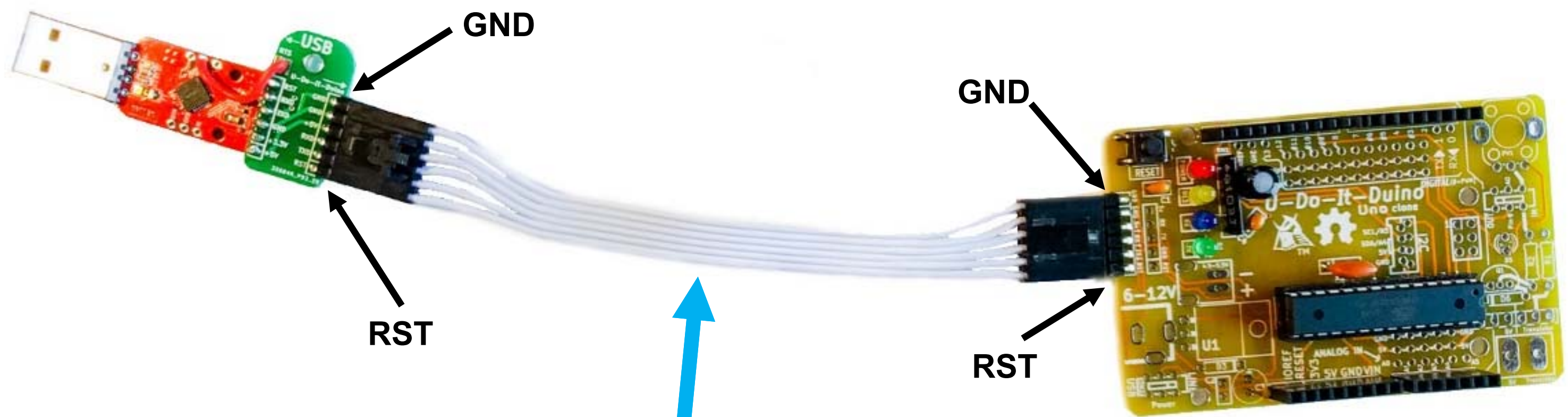

GND

RST

GND

RST

no twists



# Arduino

**After you download and install the Arduino software start it, and you will see a screen that looks like this:**

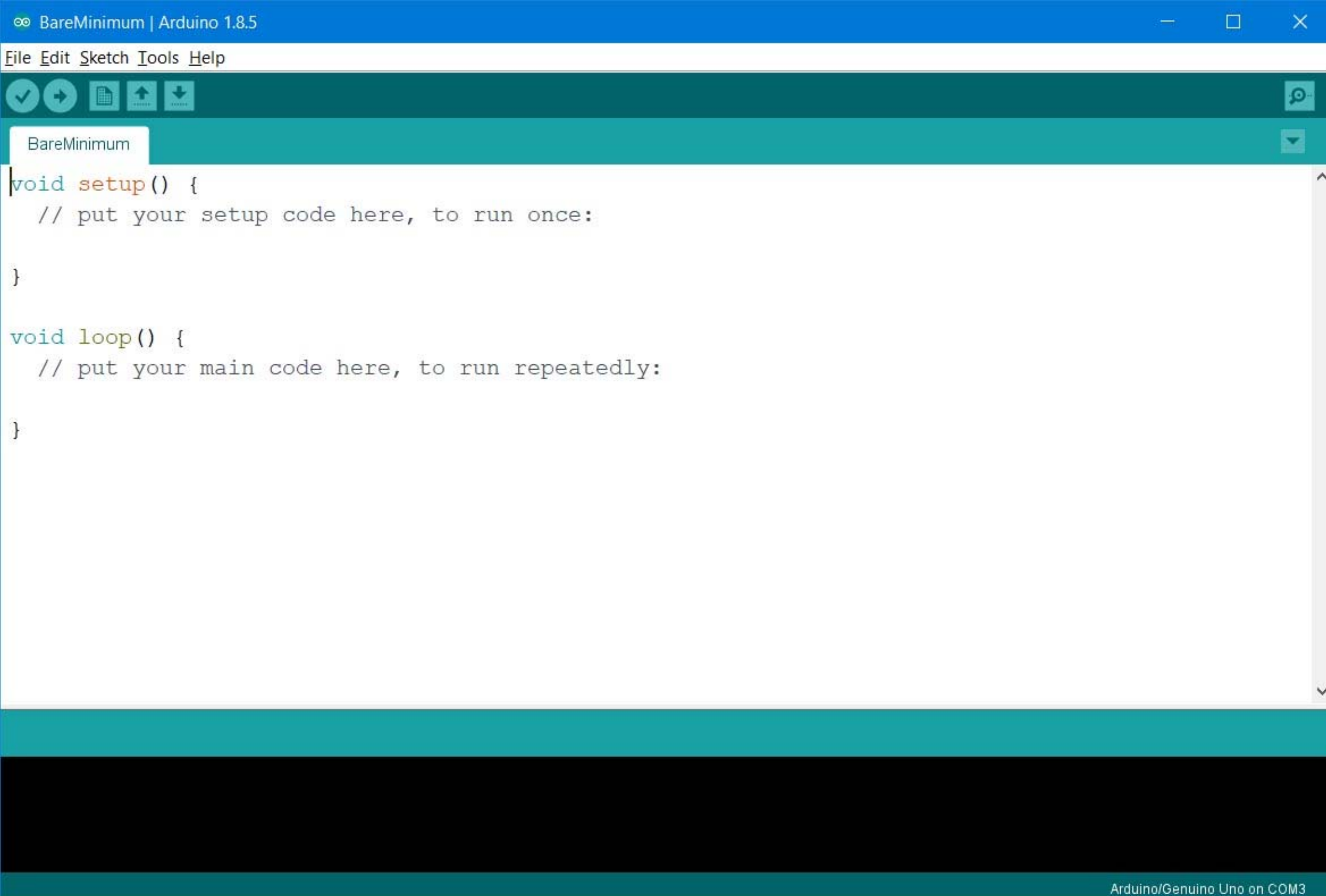

The screenshot shows the Arduino IDE interface. The title bar reads "BareMinimum | Arduino 1.8.5". The menu bar includes "File", "Edit", "Sketch", "Tools", and "Help". Below the menu bar is a toolbar with icons for saving, undo, redo, and uploading. The main workspace shows a sketch named "BareMinimum" with the following code:

```
void setup() {  
  // put your setup code here, to run once:  
  
}  
  
void loop() {  
  // put your main code here, to run repeatedly:  
  
}
```

At the bottom right of the IDE, the status bar displays "Arduino/Genuino Uno on COM3".



# Arduino

## How to Set Up and Use the Arduino Software

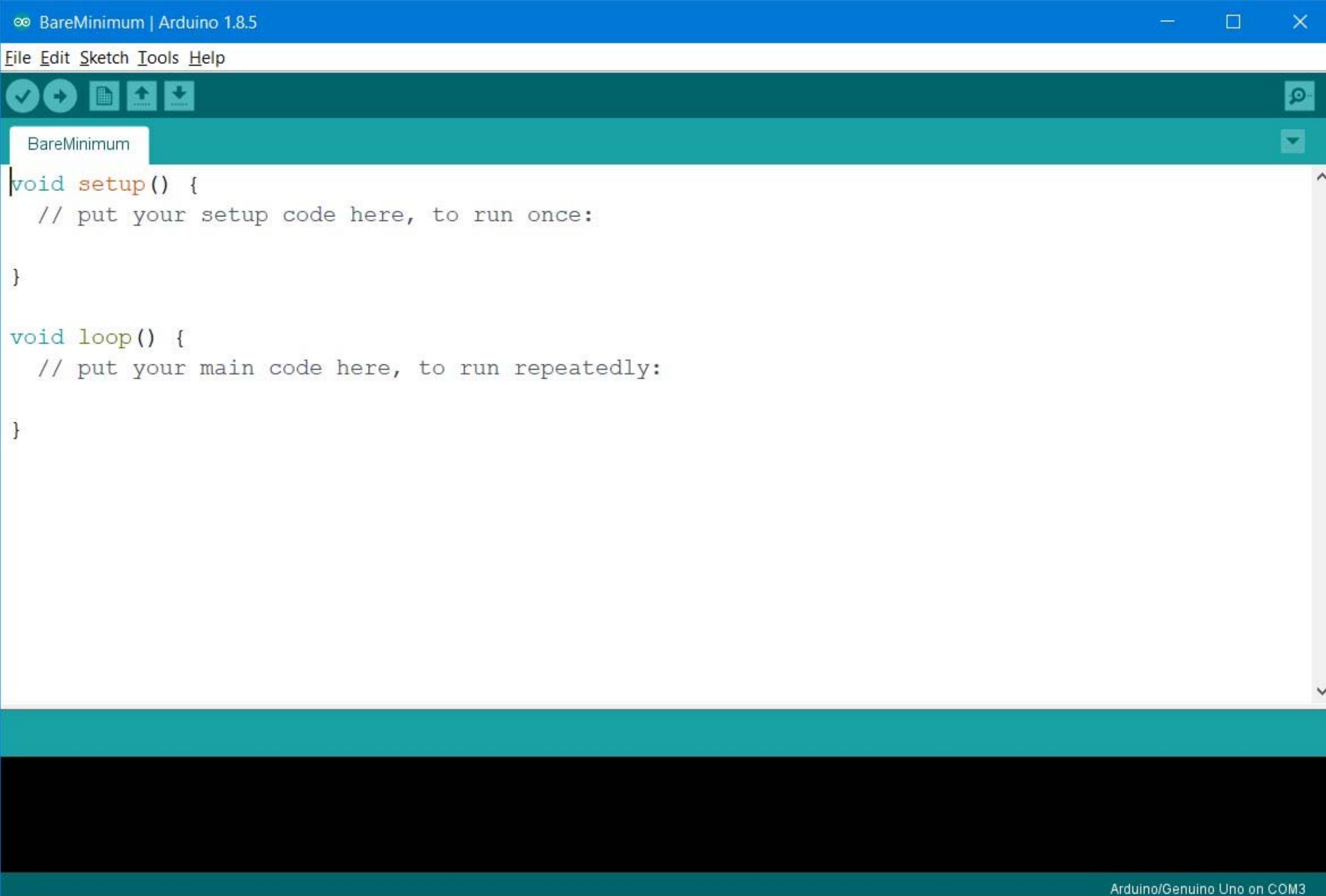

The screenshot displays the Arduino IDE interface. The title bar reads "BareMinimum | Arduino 1.8.5". The menu bar includes "File", "Edit", "Sketch", "Tools", and "Help". Below the menu bar is a toolbar with icons for saving, undo, redo, and uploading. The main workspace shows a sketch named "BareMinimum" with the following code:

```
void setup() {  
  // put your setup code here, to run once:  
  
}  
  
void loop() {  
  // put your main code here, to run repeatedly:  
  
}
```

At the bottom right of the IDE, the status bar indicates "Arduino/Genuino Uno on COM3".

# Arduino

The **first time** you start your Arduino software you need to do **two things** to set things up:

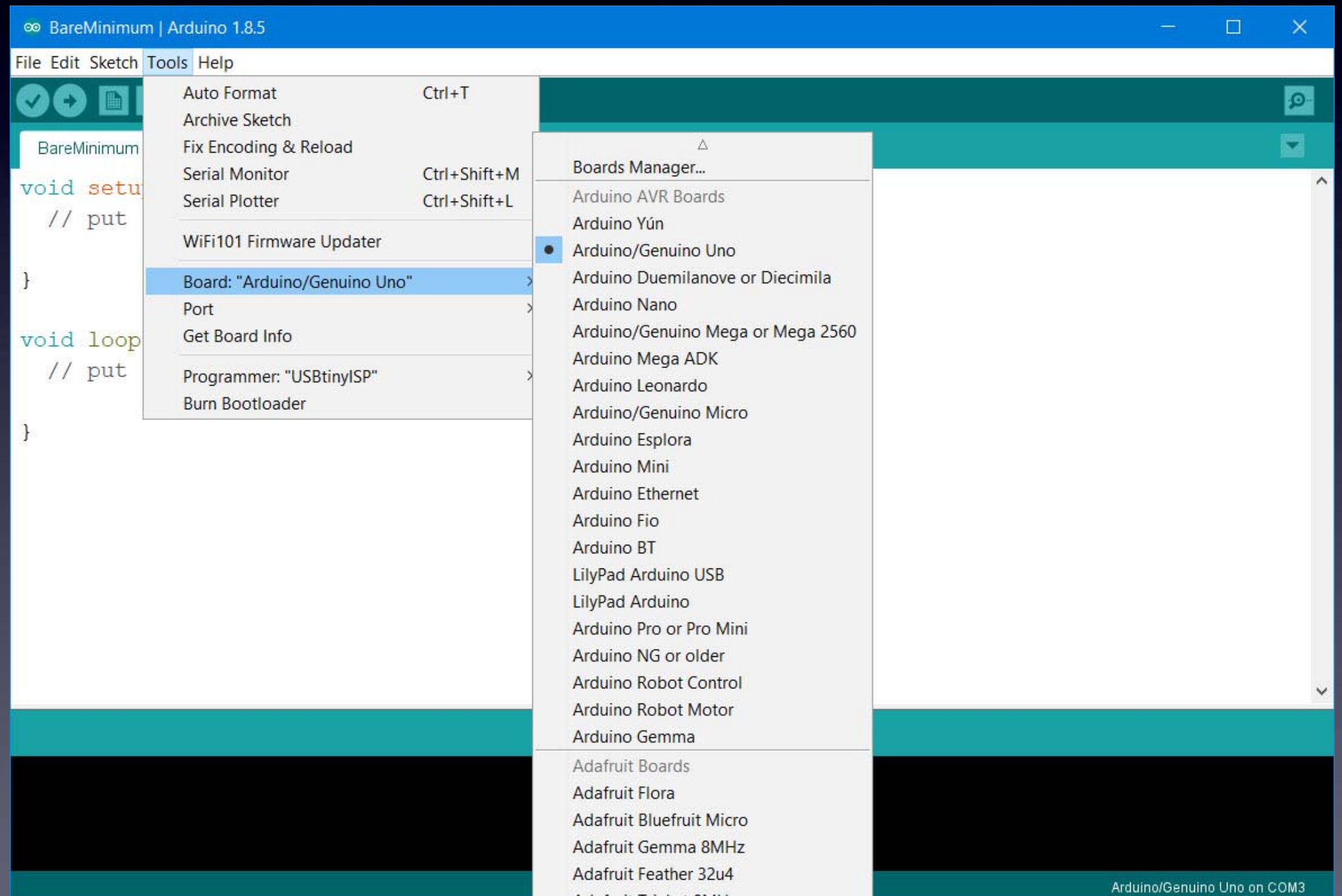

(1)  
Choose "Uno"  
as the Board

(Your  
U-Do-It-Duino  
acts  
just like  
an  
Arduino Uno board)

# Arduino

The **first time** you start your Arduino software you need to do **two things** to set things up:

(2)  
Choose  
the Port  
(this will be  
different  
depending on  
your Operating  
System)

(After installing  
the driver for  
your USB-Serial cable  
and plugging it in  
your operating system  
will see a serial port  
and it appears here.)

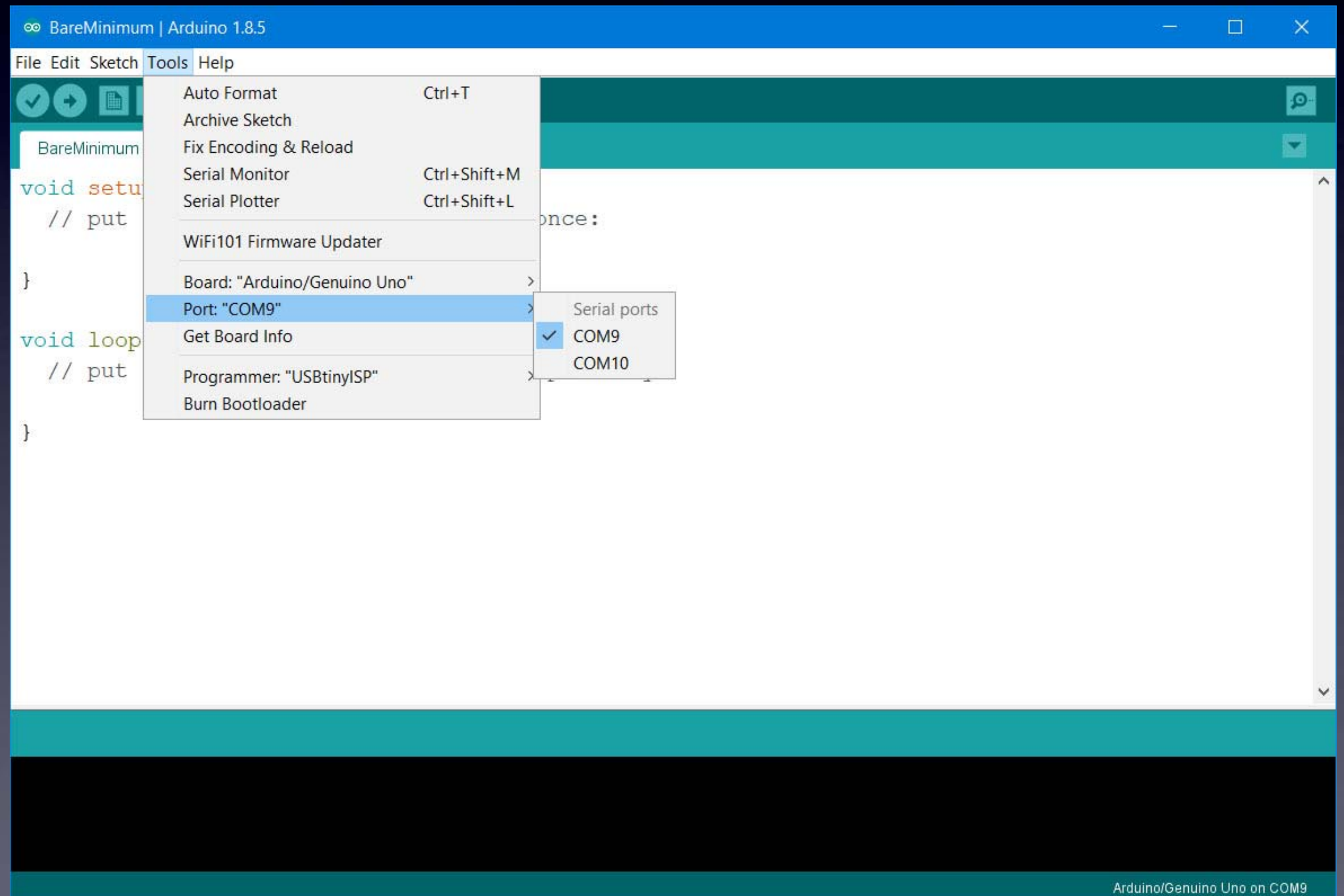

# Arduino

**Your Arduino software is now ready to program your U-Do-It-Duino !**

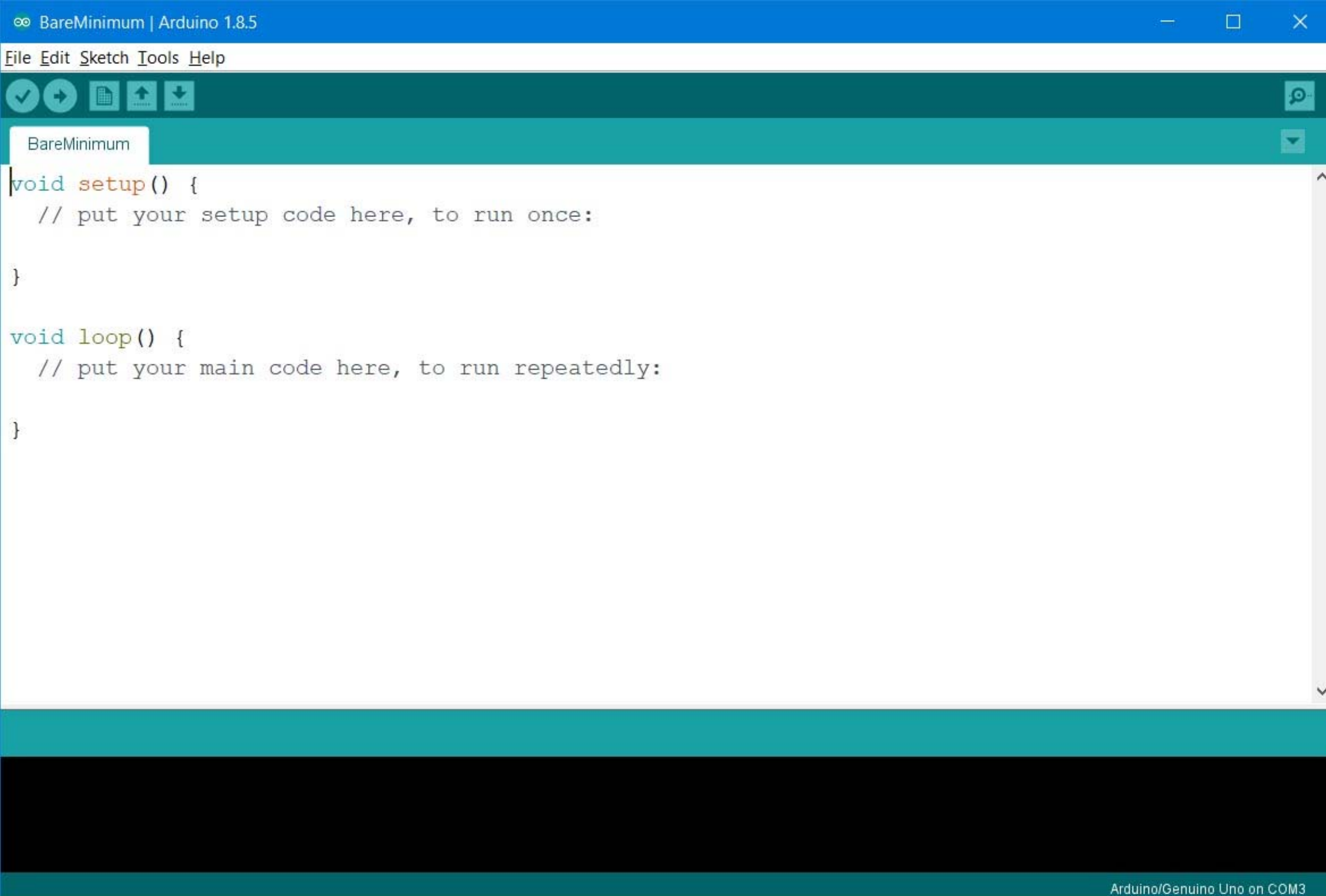

The image shows a screenshot of the Arduino IDE interface. The window title is "BareMinimum | Arduino 1.8.5". The menu bar includes "File", "Edit", "Sketch", "Tools", and "Help". The toolbar contains icons for a checkmark, a plus sign, a document, an upload arrow, and a download arrow. The main editor area shows the following code:

```
BareMinimum
void setup() {
  // put your setup code here, to run once:
}

void loop() {
  // put your main code here, to run repeatedly:
}
```

At the bottom right of the IDE, the text "Arduino/Genuino Uno on COM3" is visible.

# Arduino

Your Arduino software is now ready to program your U-Do-It-Duino !

Let's make an LED blink! Hello World

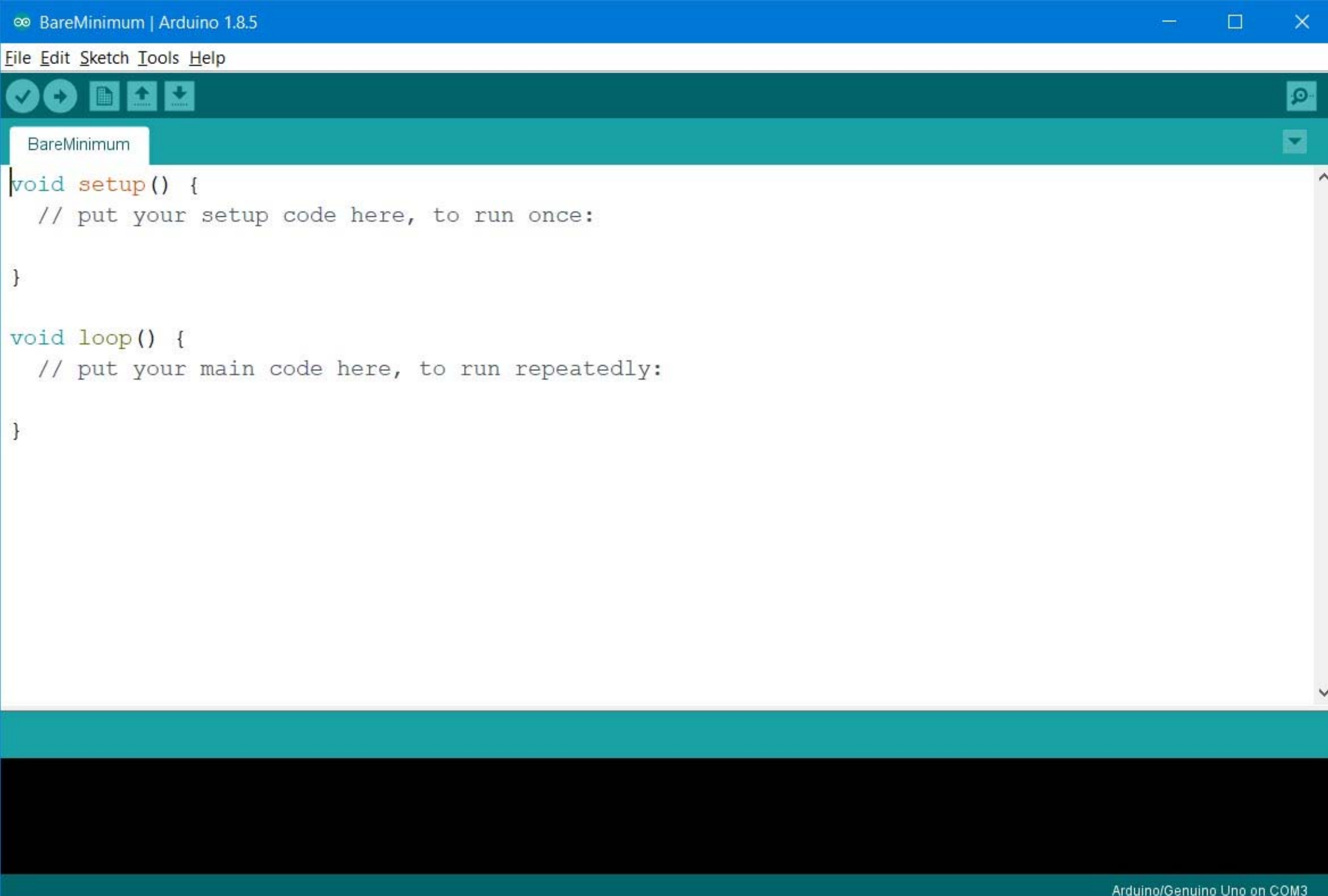

```
BareMinimum | Arduino 1.8.5
File Edit Sketch Tools Help
BareMinimum
void setup() {
  // put your setup code here, to run once:
}

void loop() {
  // put your main code here, to run repeatedly:
}

Arduino/Genuino Uno on COM3
```

# Arduino

Your Arduino software is now ready to program your U-Do-It-Duino !

Let's make an LED blink! Hello World

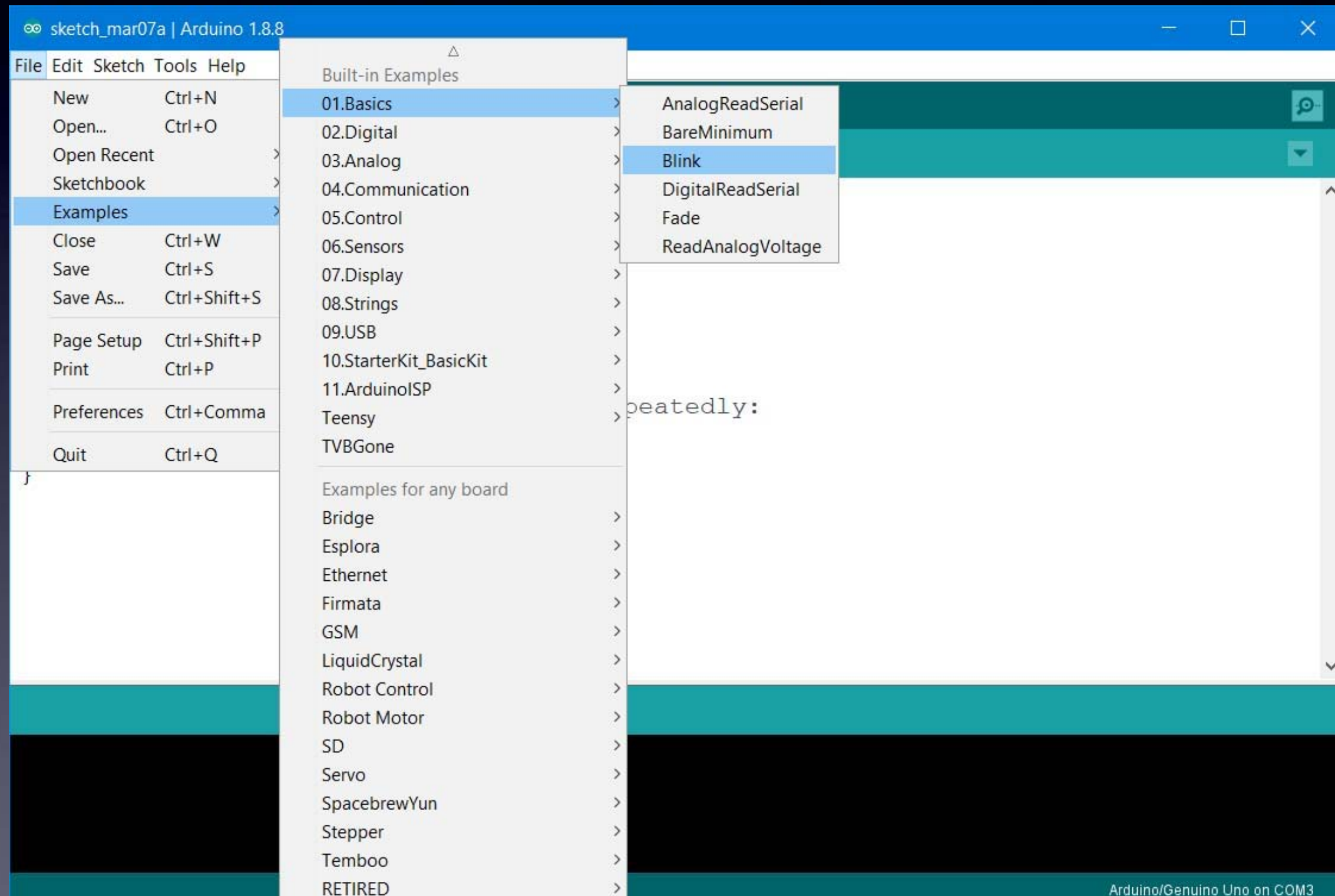

# Arduino

Let's make an LED blink! Hello World

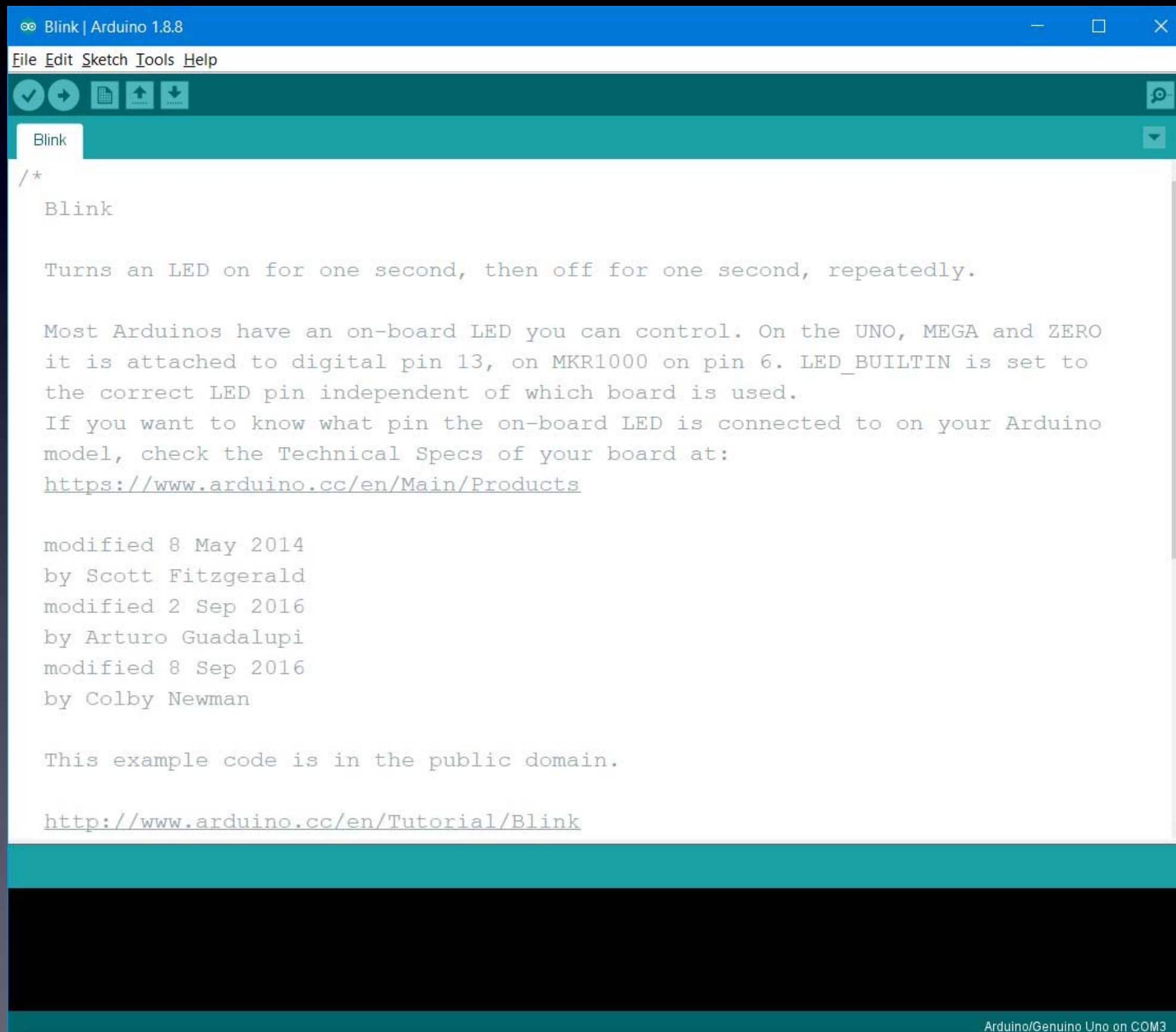

The image shows a screenshot of the Arduino IDE interface. The window title is "Blink | Arduino 1.8.8". The menu bar includes "File", "Edit", "Sketch", "Tools", and "Help". The toolbar contains icons for a checkmark, a right arrow, a document, an upload arrow, and a download arrow. The main editor area shows the "Blink" example code. The code is enclosed in a multi-line comment block. The text of the comment includes: "Blink", "Turns an LED on for one second, then off for one second, repeatedly.", "Most Arduinos have an on-board LED you can control. On the UNO, MEGA and ZERO it is attached to digital pin 13, on MKR1000 on pin 6. LED\_BUILTIN is set to the correct LED pin independent of which board is used.", "If you want to know what pin the on-board LED is connected to on your Arduino model, check the Technical Specs of your board at:", "<https://www.arduino.cc/en/Main/Products>", "modified 8 May 2014", "by Scott Fitzgerald", "modified 2 Sep 2016", "by Arturo Guadalupi", "modified 8 Sep 2016", "by Colby Newman", "This example code is in the public domain.", and "<http://www.arduino.cc/en/Tutorial/Blink>". The status bar at the bottom right indicates "Arduino/Genuino Uno on COM3".

```
/*  
Blink  
  
Turns an LED on for one second, then off for one second, repeatedly.  
  
Most Arduinos have an on-board LED you can control. On the UNO, MEGA and ZERO  
it is attached to digital pin 13, on MKR1000 on pin 6. LED_BUILTIN is set to  
the correct LED pin independent of which board is used.  
If you want to know what pin the on-board LED is connected to on your Arduino  
model, check the Technical Specs of your board at:  
https://www.arduino.cc/en/Main/Products  
  
modified 8 May 2014  
by Scott Fitzgerald  
modified 2 Sep 2016  
by Arturo Guadalupi  
modified 8 Sep 2016  
by Colby Newman  
  
This example code is in the public domain.  
  
http://www.arduino.cc/en/Tutorial/Blink*/
```

# Arduino

Let's make an LED blink! Hello World

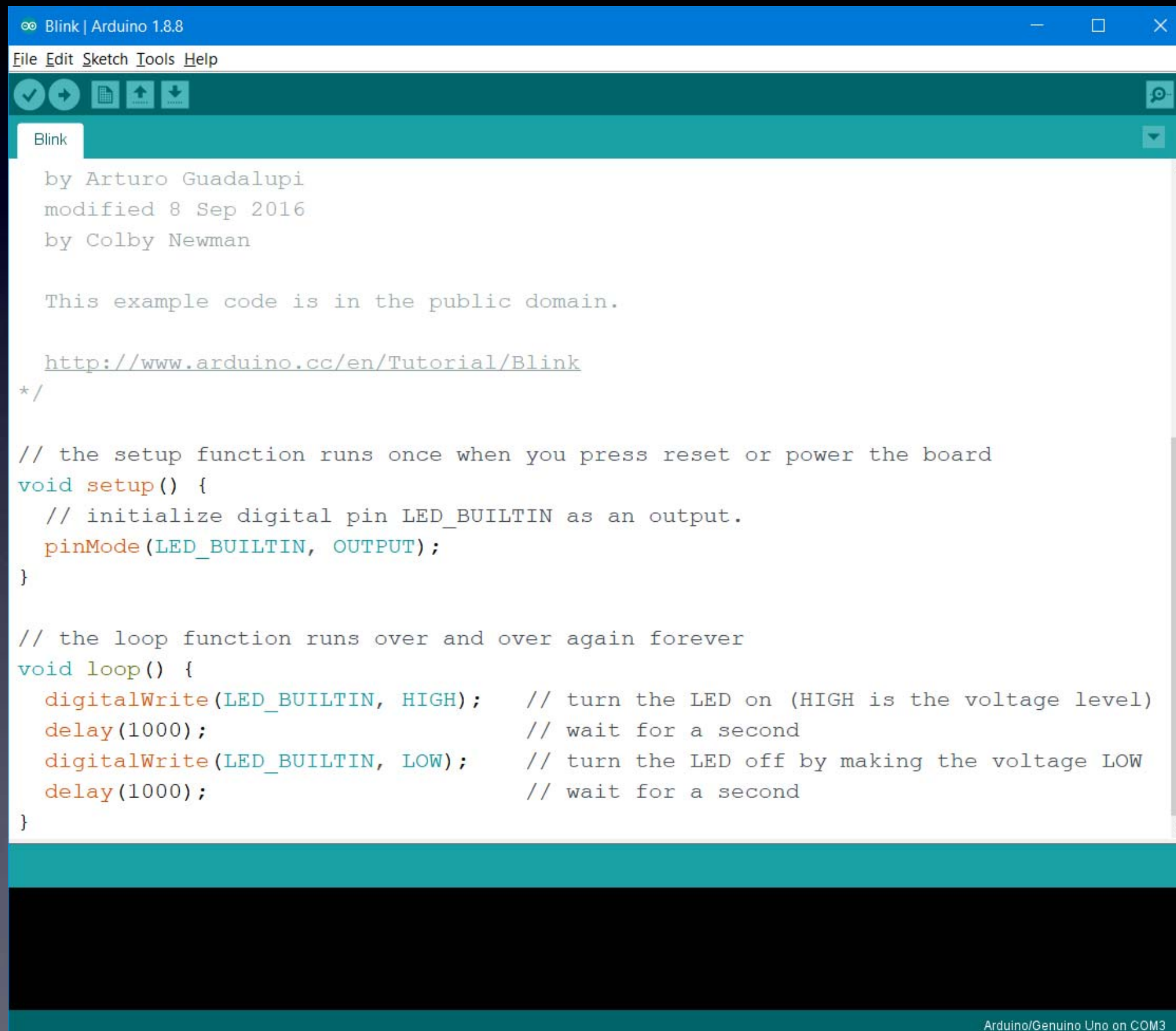
A screenshot of the Arduino IDE interface. The window title is "Blink | Arduino 1.8.8". The menu bar includes "File", "Edit", "Sketch", "Tools", and "Help". The toolbar contains icons for a checkmark, a right arrow, a document, an upload arrow, and a download arrow. The sketch name "Blink" is shown in a tab. The code editor contains the following text:

```
by Arturo Guadalupi
modified 8 Sep 2016
by Colby Newman

This example code is in the public domain.

http://www.arduino.cc/en/Tutorial/Blink
*/

// the setup function runs once when you press reset or power the board
void setup() {
  // initialize digital pin LED_BUILTIN as an output.
  pinMode(LED_BUILTIN, OUTPUT);
}

// the loop function runs over and over again forever
void loop() {
  digitalWrite(LED_BUILTIN, HIGH); // turn the LED on (HIGH is the voltage level)
  delay(1000); // wait for a second
  digitalWrite(LED_BUILTIN, LOW); // turn the LED off by making the voltage LOW
  delay(1000); // wait for a second
}
```

The status bar at the bottom right indicates "Arduino/Genuino Uno on COM3".

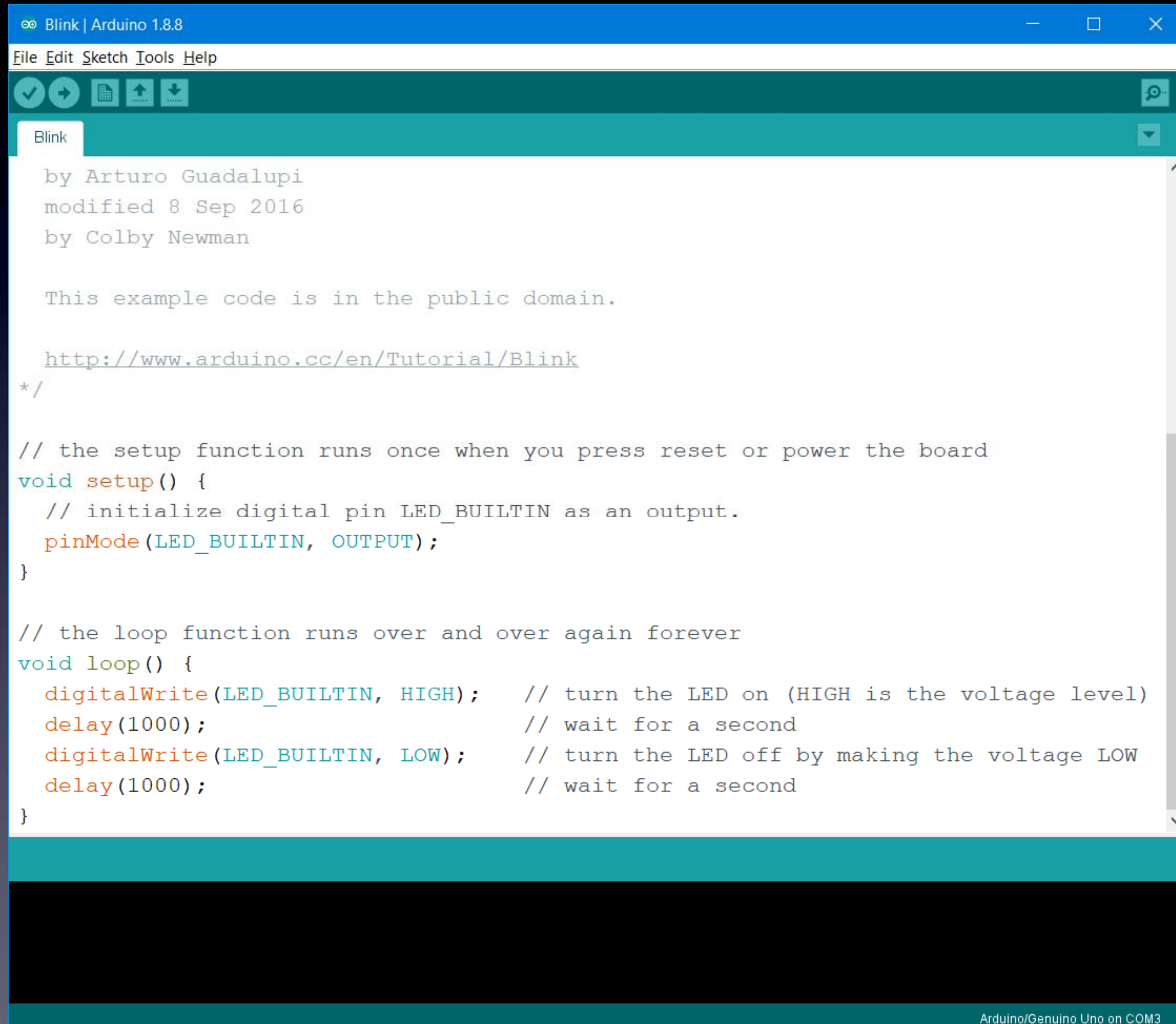

# How to Hack Arduino Programs (“Sketches”)

A screenshot of the Arduino IDE interface. The window title is "Blink | Arduino 1.8.8". The menu bar includes "File", "Edit", "Sketch", "Tools", and "Help". Below the menu bar is a toolbar with icons for checkmark, undo, redo, save, and upload. A tab labeled "Blink" is active. The main text area contains the following code:

```
by Arturo Guadalupi
modified 8 Sep 2016
by Colby Newman

This example code is in the public domain.

http://www.arduino.cc/en/Tutorial/Blink
*/

// the setup function runs once when you press reset or power the board
void setup() {
  // initialize digital pin LED_BUILTIN as an output.
  pinMode(LED_BUILTIN, OUTPUT);
}

// the loop function runs over and over again forever
void loop() {
  digitalWrite(LED_BUILTIN, HIGH); // turn the LED on (HIGH is the voltage level)
  delay(1000); // wait for a second
  digitalWrite(LED_BUILTIN, LOW); // turn the LED off by making the voltage LOW
  delay(1000); // wait for a second
}
```

At the bottom right of the IDE, the text "Arduino/Genuino Uno on COM3" is visible.

# How to Hack Arduino Programs (“Sketches”)

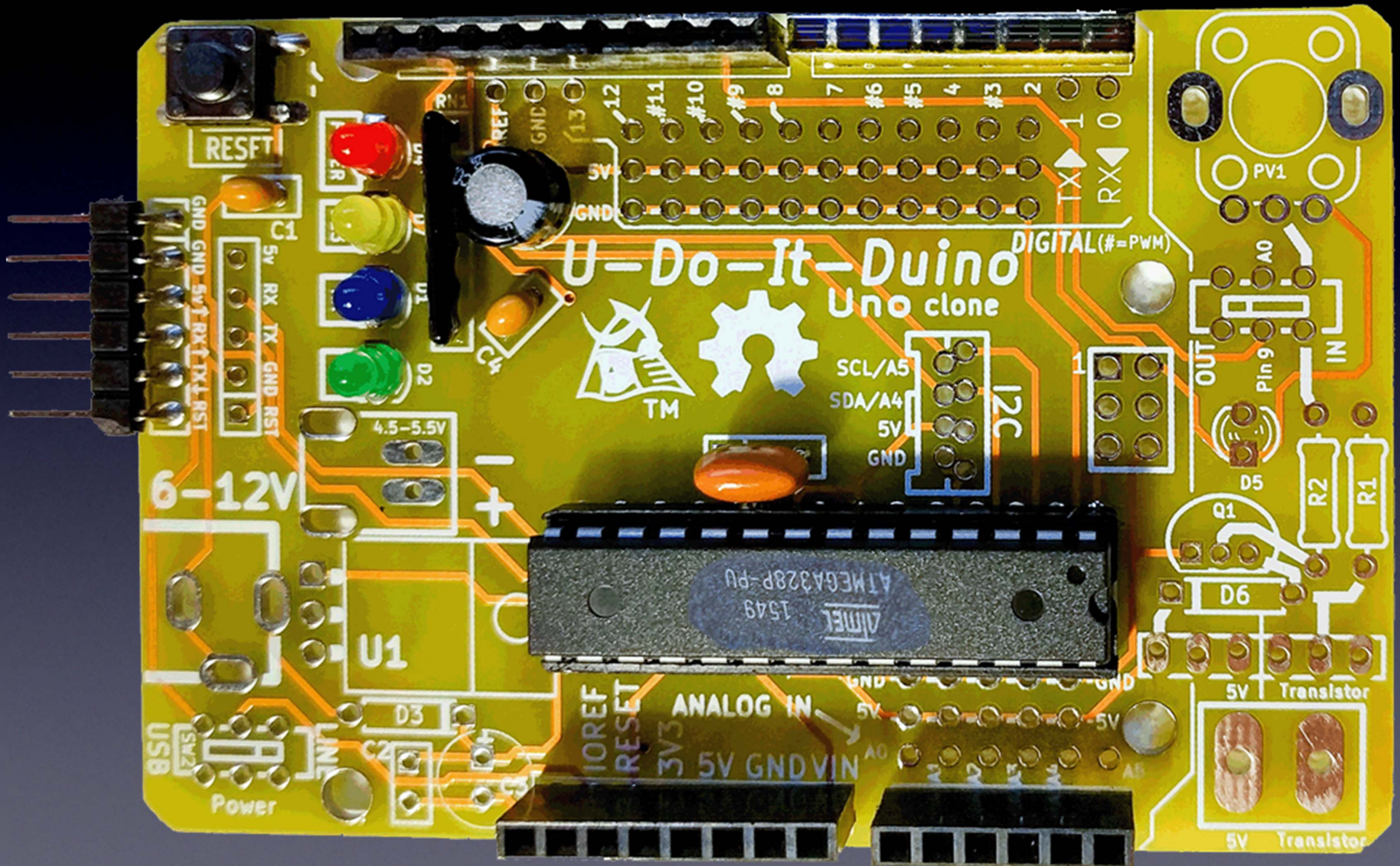

# How to Use Solderless Breadboards

## Solderless Breadboard

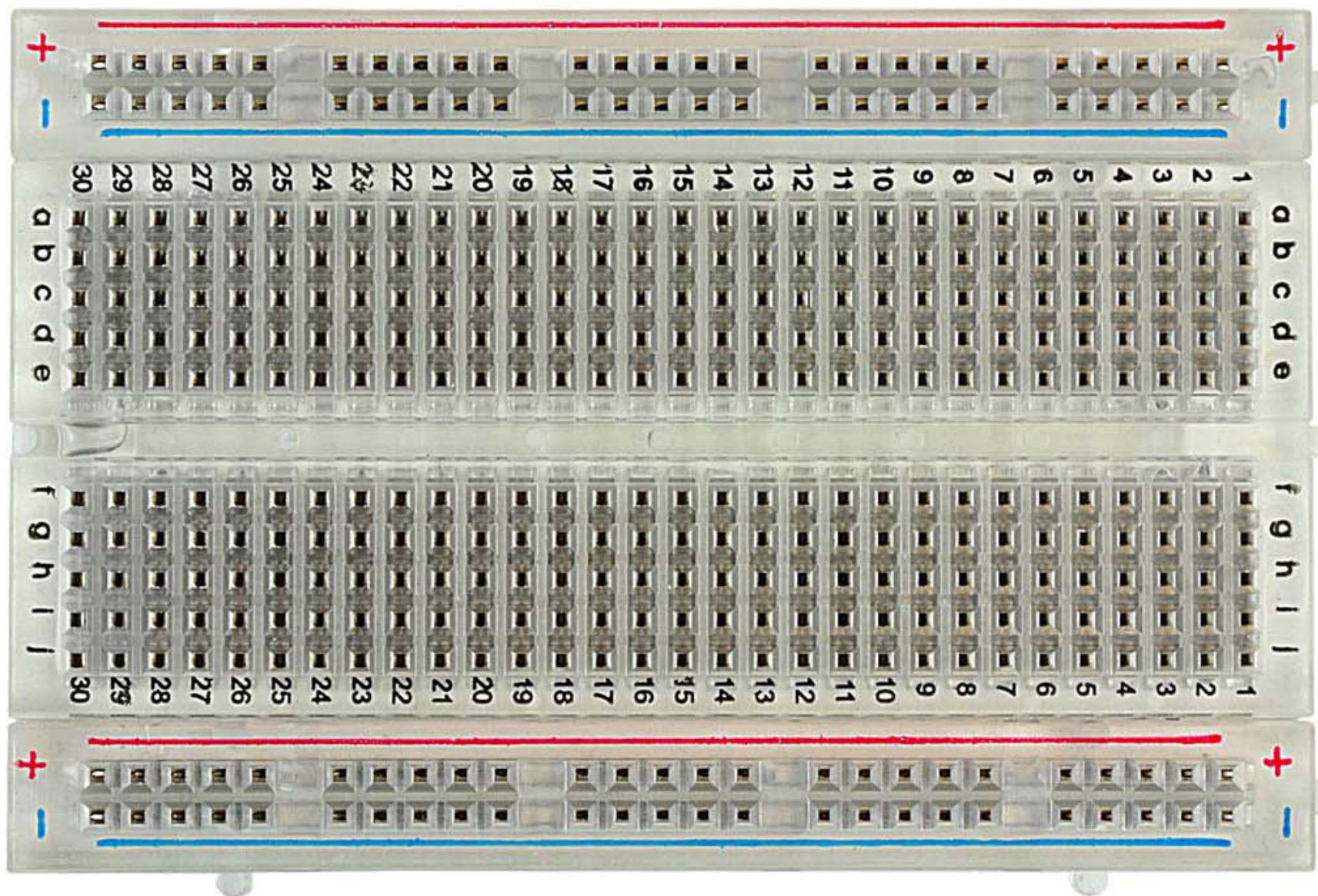

# How to Use Solderless Breadboards

## Solderless Breadboard with LED

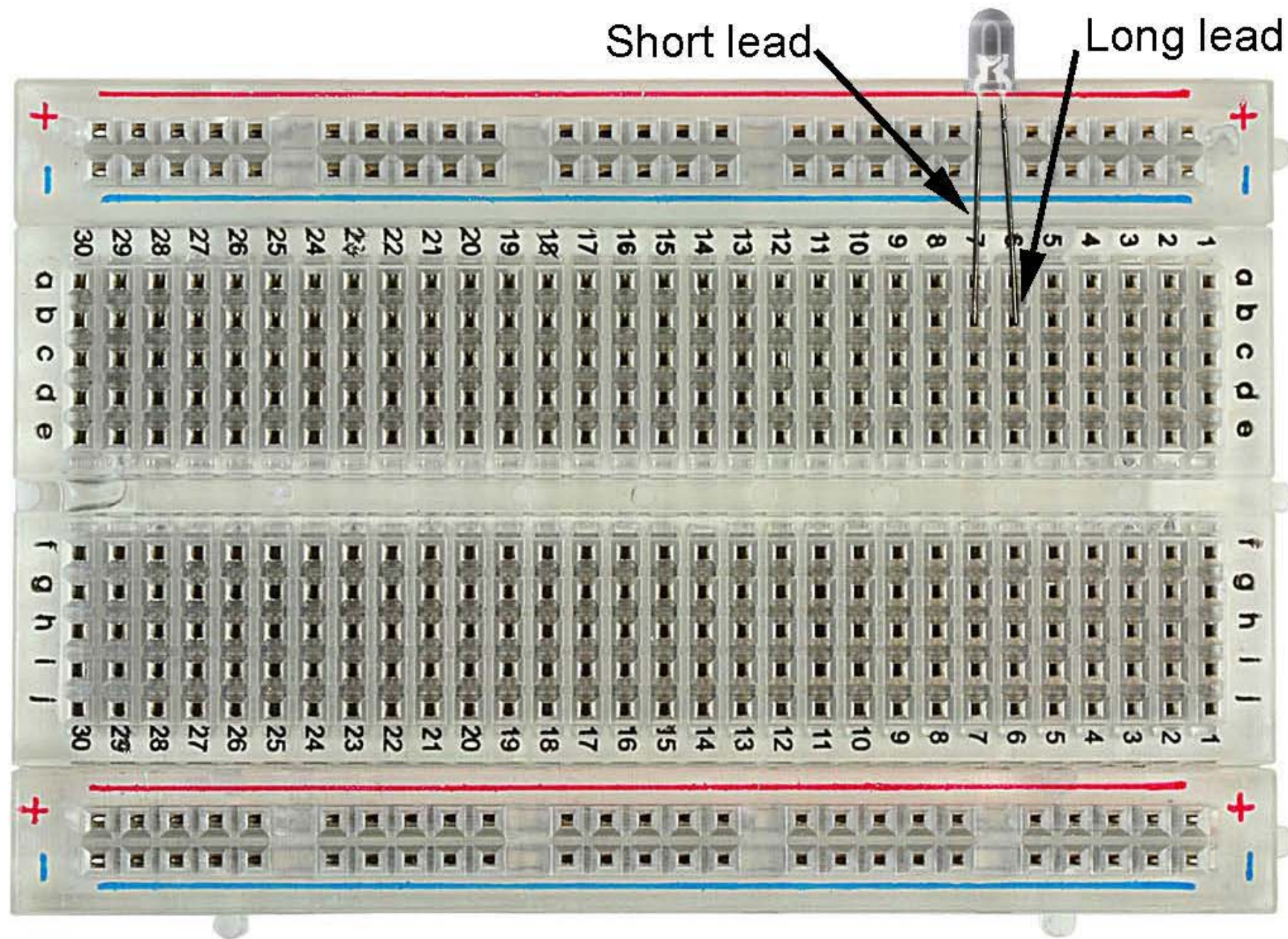

# How to Use Solderless Breadboards

## Solderless Breadboard with LED and wires

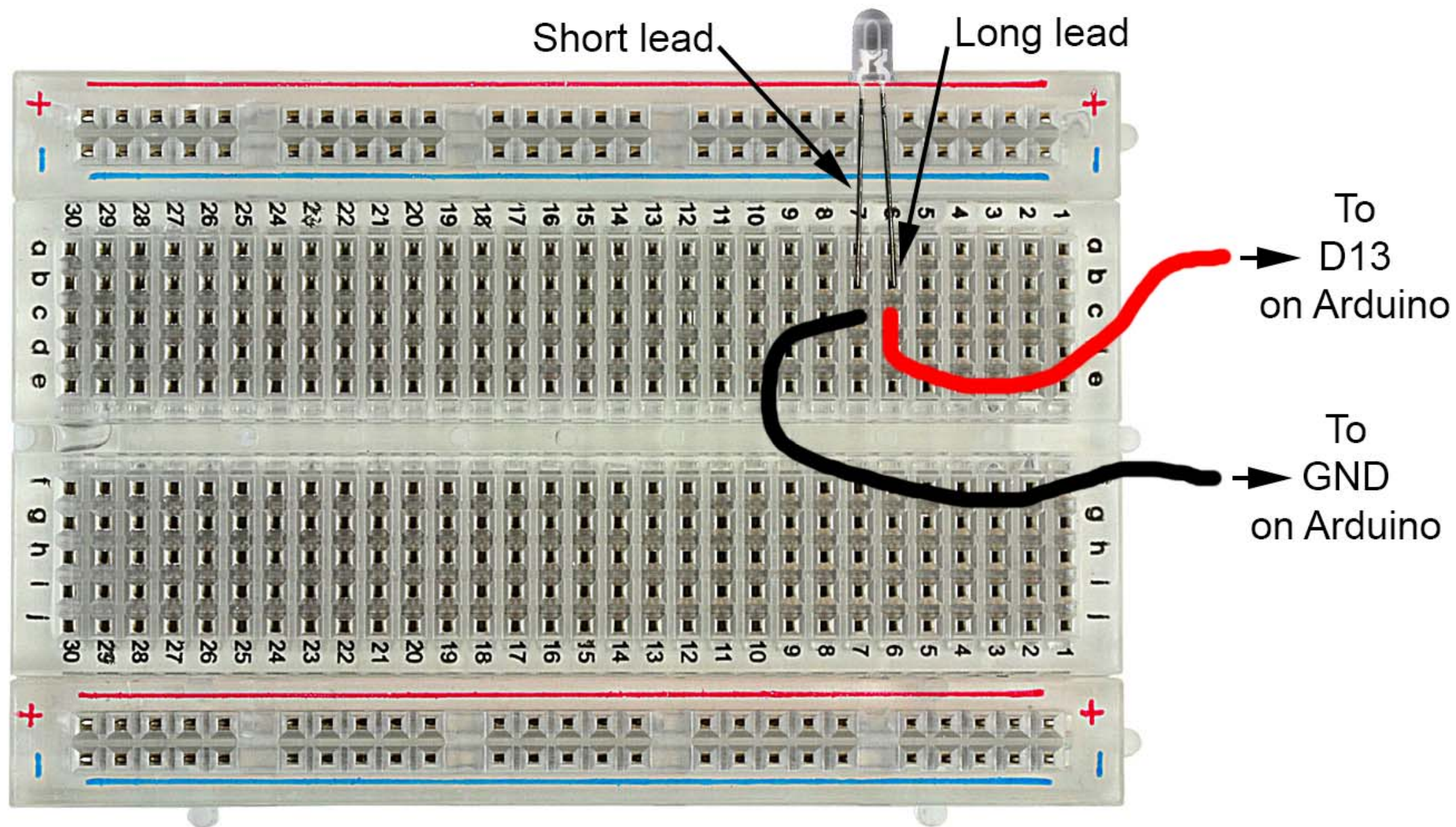

# How to Use Solderless Breadboards

## Solderless Breadboard with LED and Resistor and wires

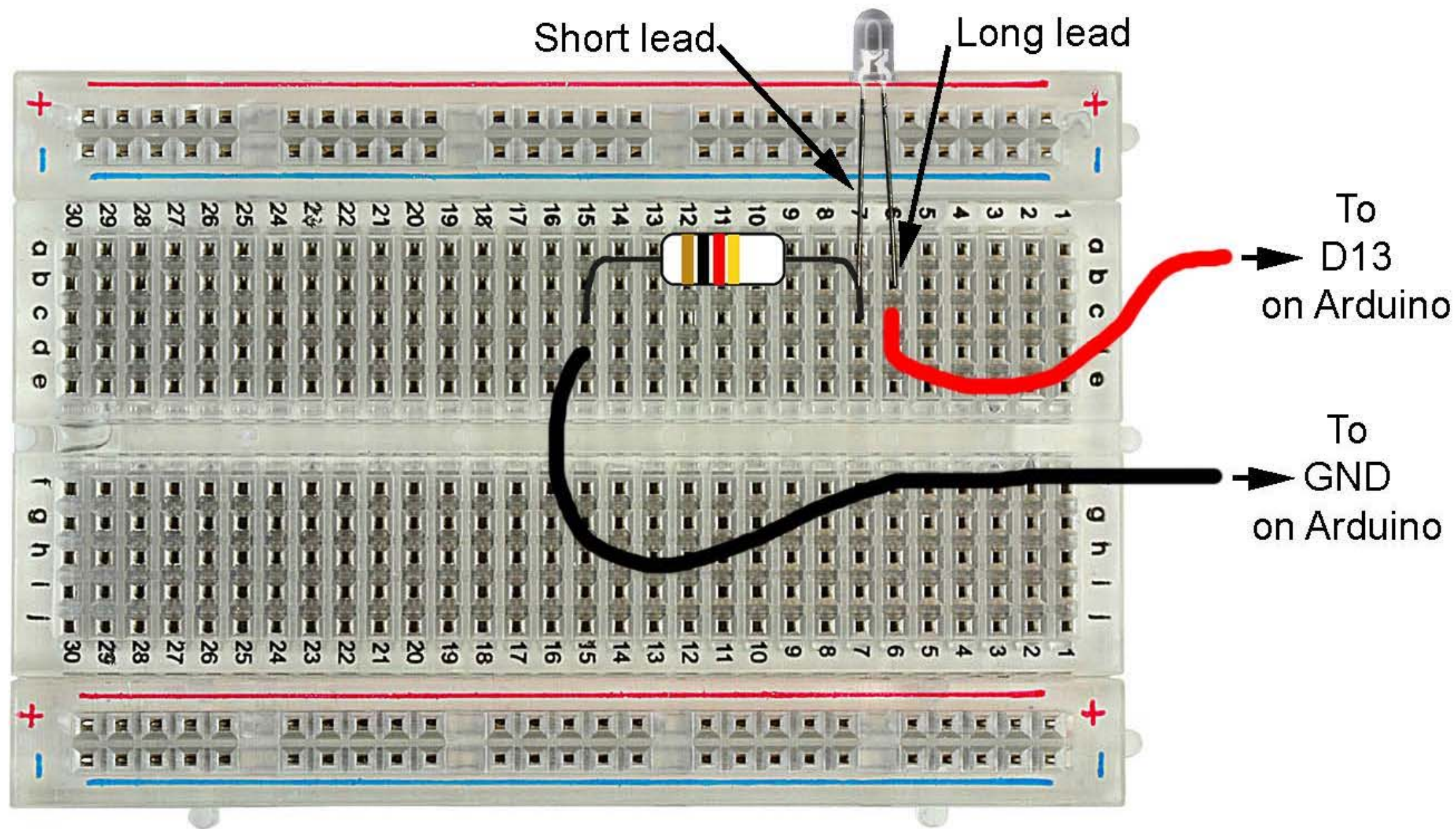

# How to Read a Schematic

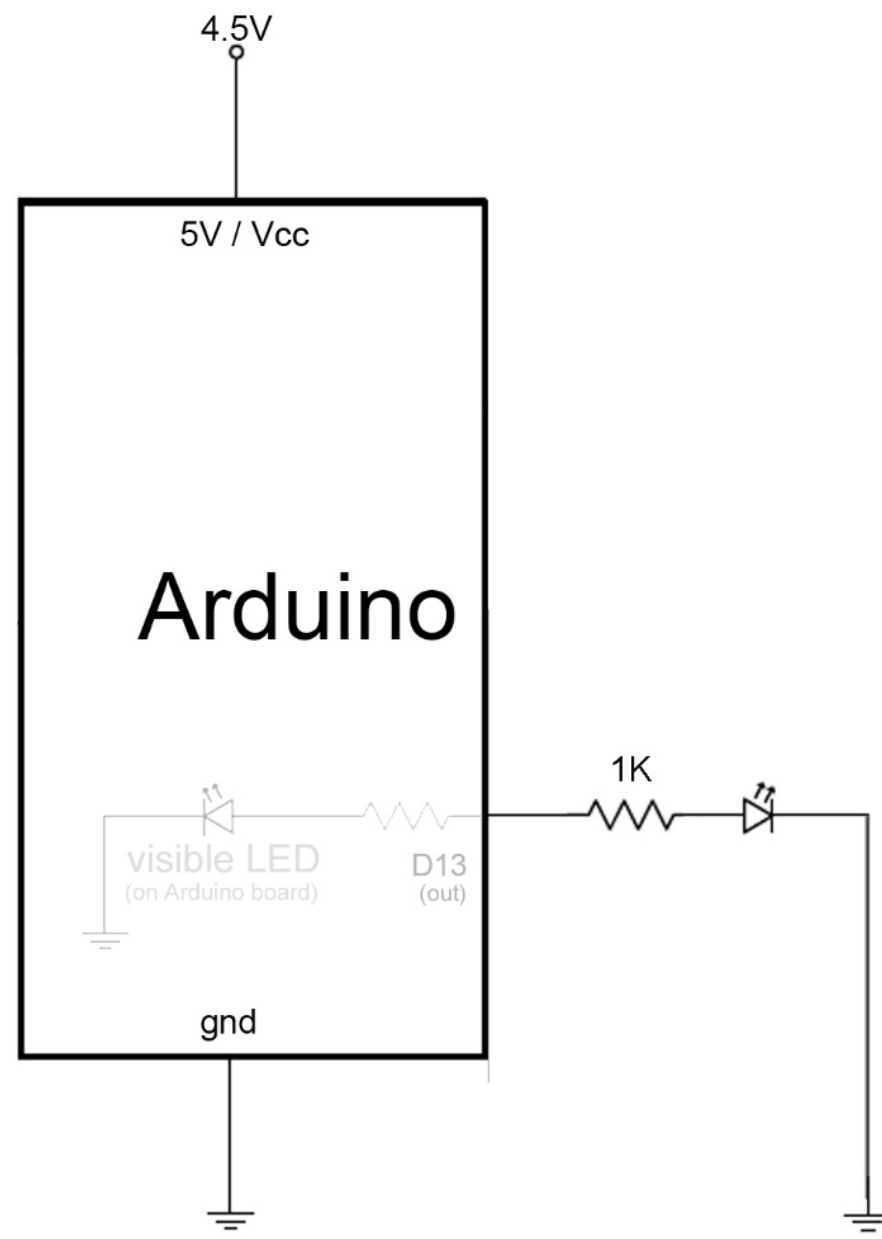

# How to Read a Schematic

## Arduino For Total Newbies

4-Sep-2015

Mitch Altman (original TV-B-Gone hardware and firmware, modified TV-B-Gone Arduino design)  
Limore Fried (firmware modifications, kit design)  
Ken Shirriff (original modifications for Arduino)  
Johannes Schneemann (documentation)

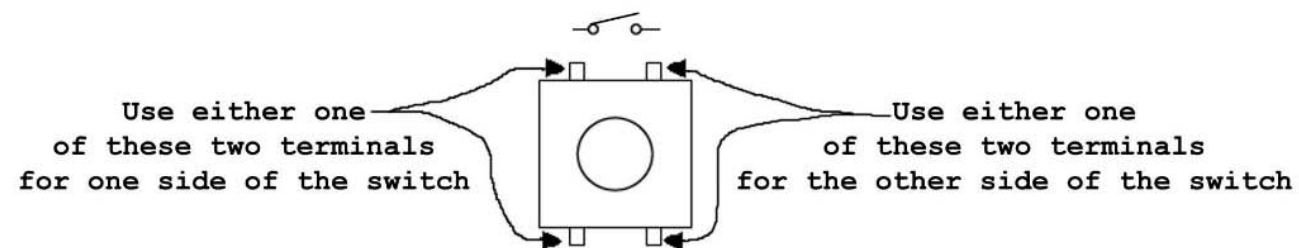
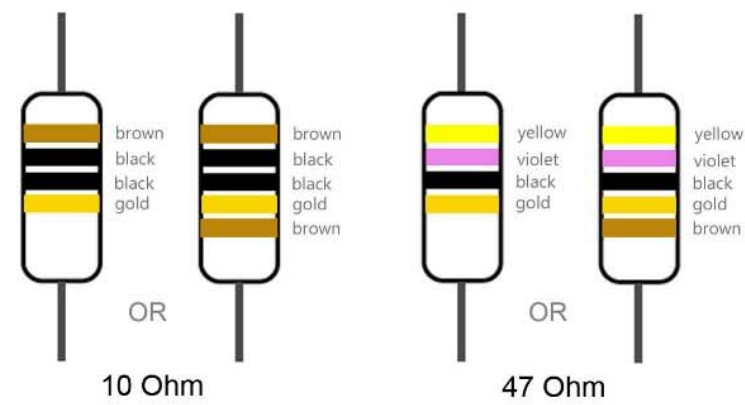
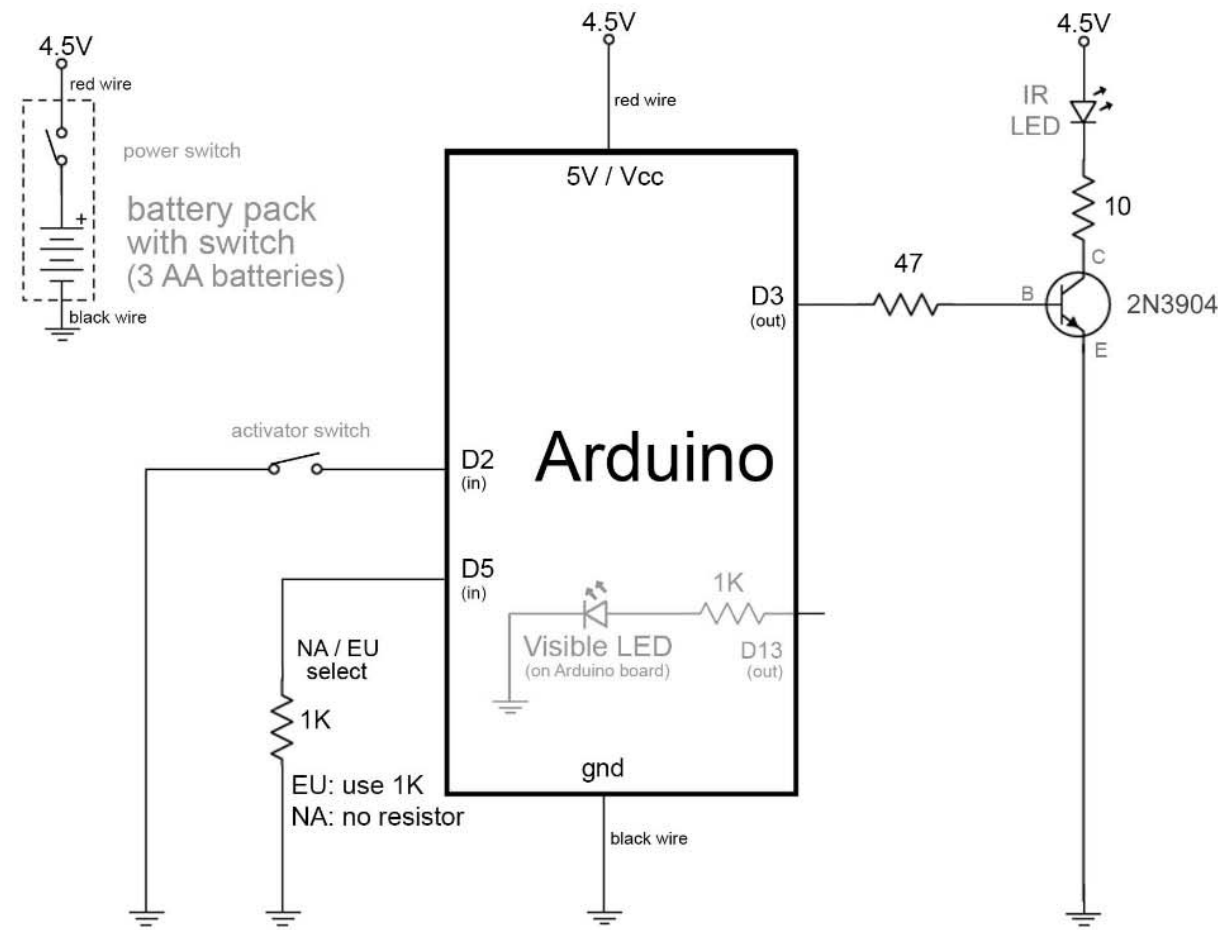



# Parts Pack Contents

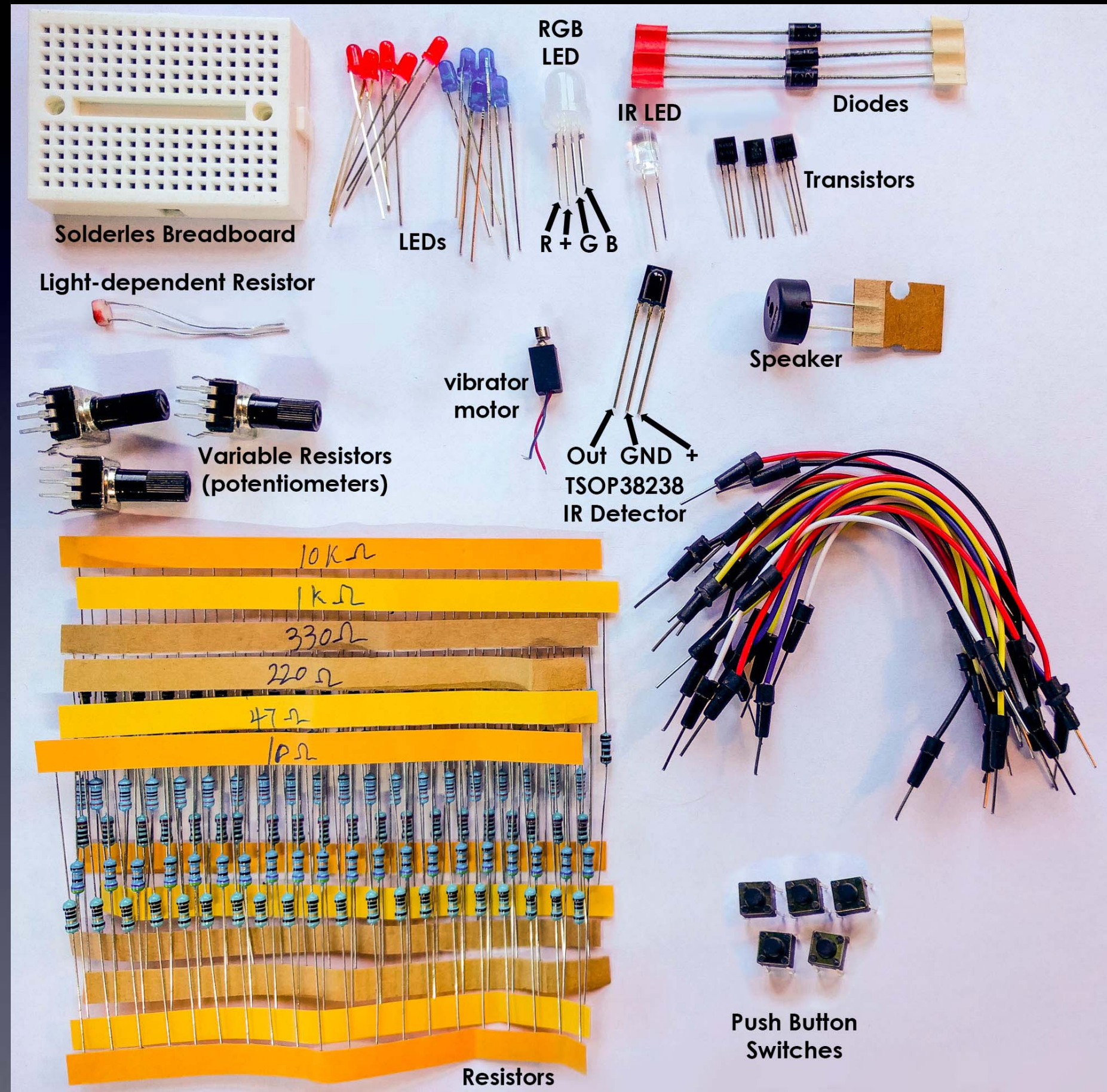

# If you want to:

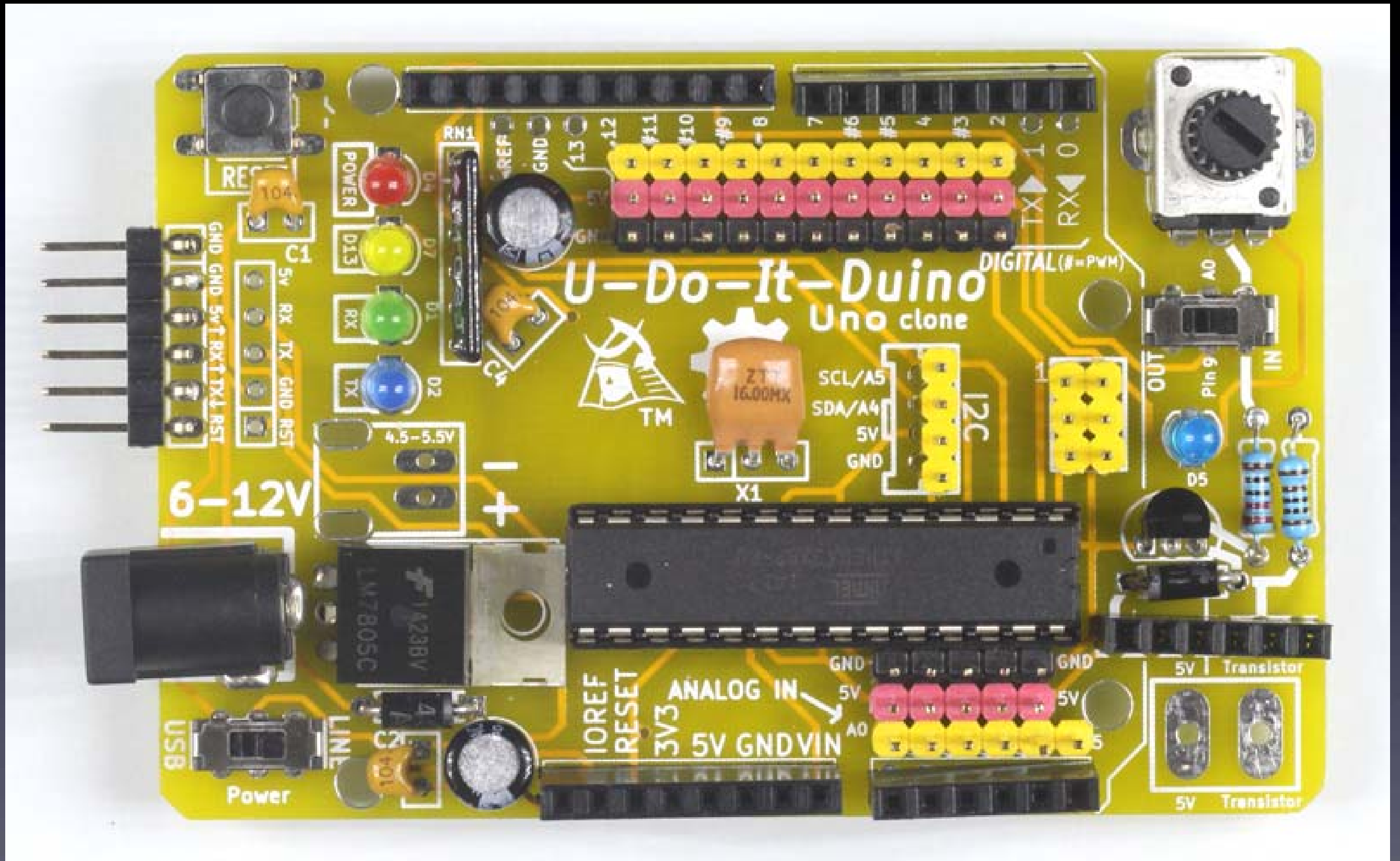

(or just search for: U-Do-It-Duino online)

<http://www.samuraicircuits.com/MediaWiki/index.php?title=U-Do-It-Duino>

I have these  
Toolkits  
for sale

# Tools

