

Arduino For Total Newbies

w/ TV-B-Gone as example project

Mitch Altman

Chief Scientist, **Cornfield Electronics**, San Francisco, CA
Inventor of **TV-B-Gone** universal remote controls
Co-founder of **3Ware** (successful Silicon Valley startup)
Pioneer of **VR** (in the mid-1980s)
Founding mentor at **HAX** (1st and biggest hardware accelerator)
Co-founder of **Noisebridge** (San Francisco hackerspace)
email: mitch@CornfieldElectronics.com
site: www.CornfieldElectronics.com
facebook: [maltman23](https://www.facebook.com/maltman23)
flickr: [maltman23](https://www.flickr.com/photos/maltman23/)
WeChat: [mitchaltman](https://www.wechat.com/qrcode?scene=scene_qr_code)
Fediverse: [@maltman23@mastodon.social](https://maltman23@mastodon.social)
Patreon: [mitchaltman](https://www.patreon.com/mitchaltman)



Syllabus

- Intro
- Everything You Need to Know About Electronics
- *[How to solder / make your own Arduino] ← not in today's workshop*
- How to Set Up and Use the Arduino Software
- How to Hack Arduino Programs (“Sketches”)
- How to Use Solderless Breadboards
- How to Read a Schematic
- Make a TV-B-Gone Remote Control with your Arduino Clone without soldering

Intro

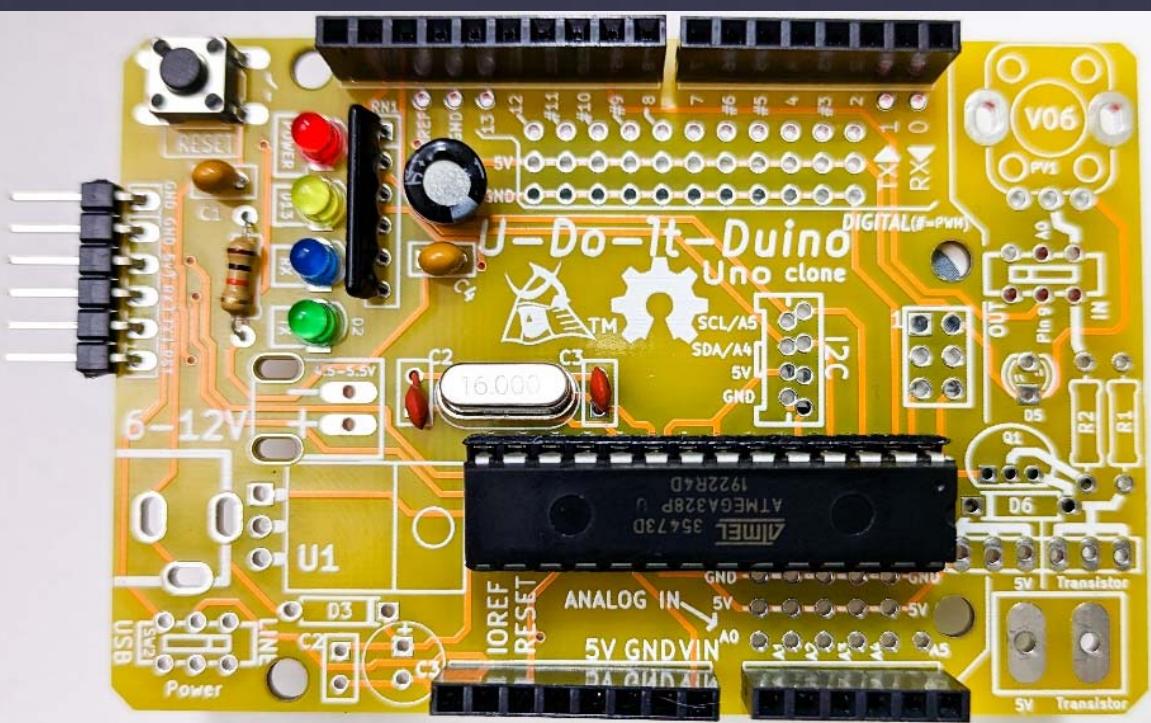
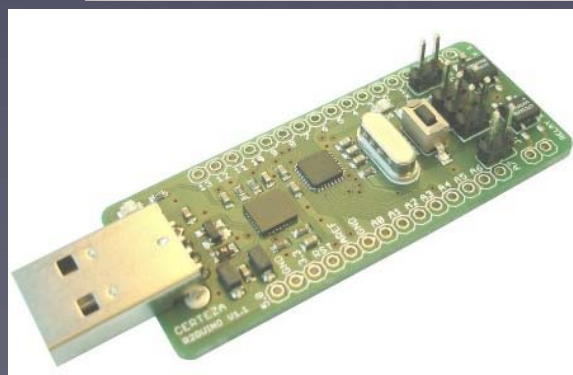
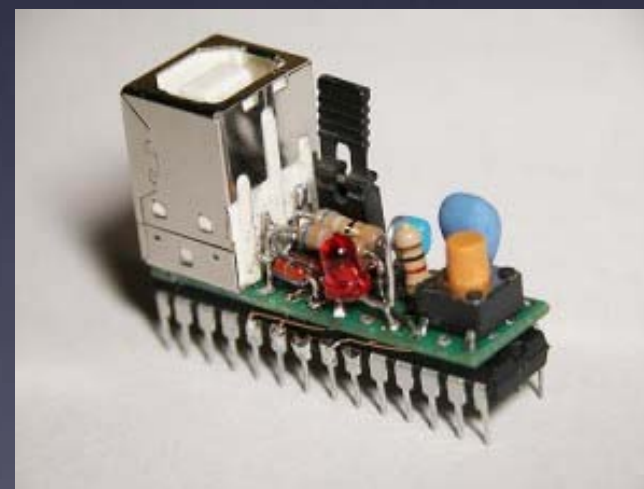
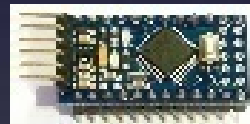
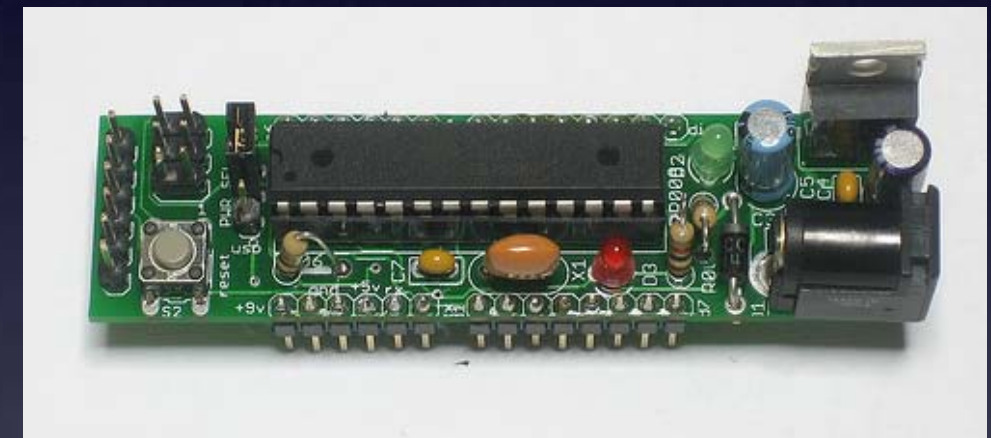
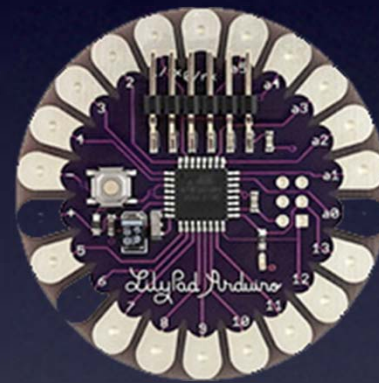
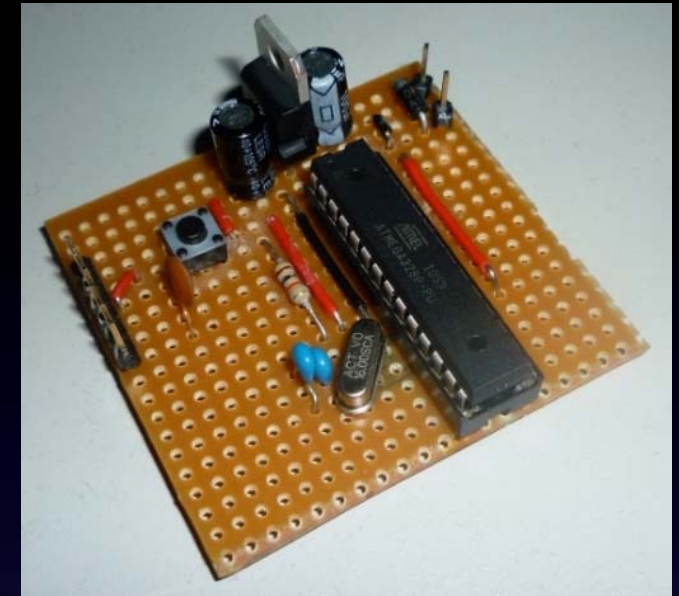
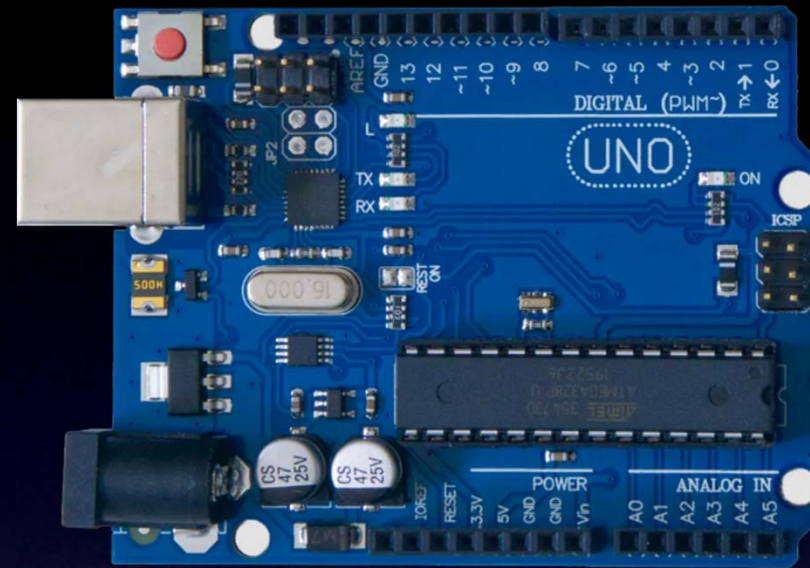
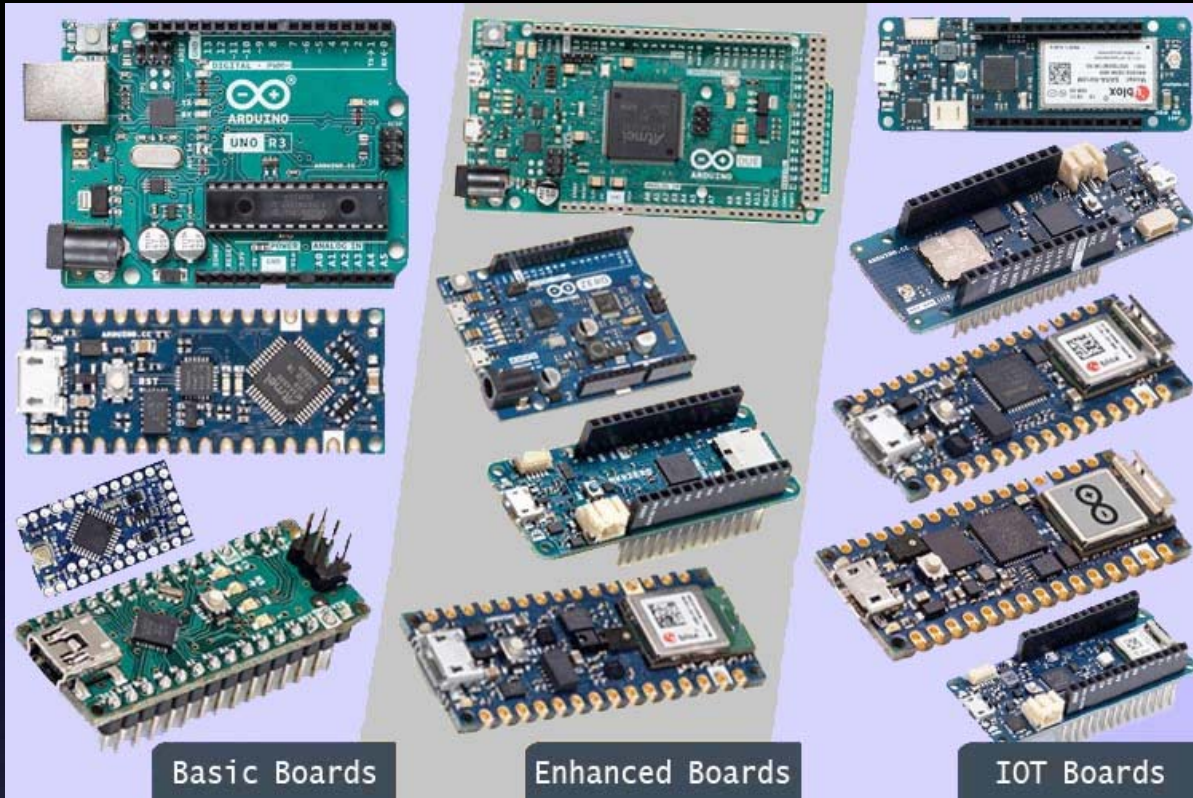

Everything You Need to Know About Electronics

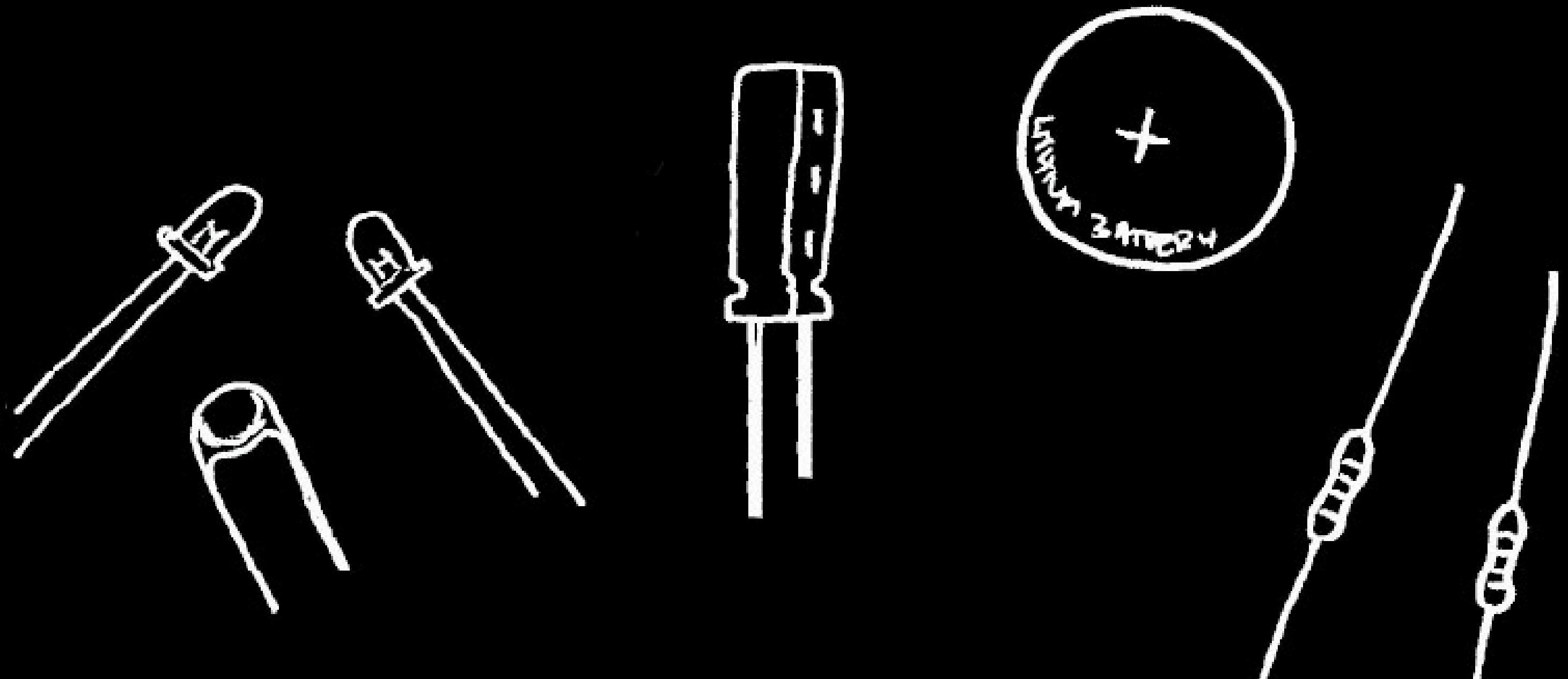

Learn To Solder

We will not solder in this version of the workshop

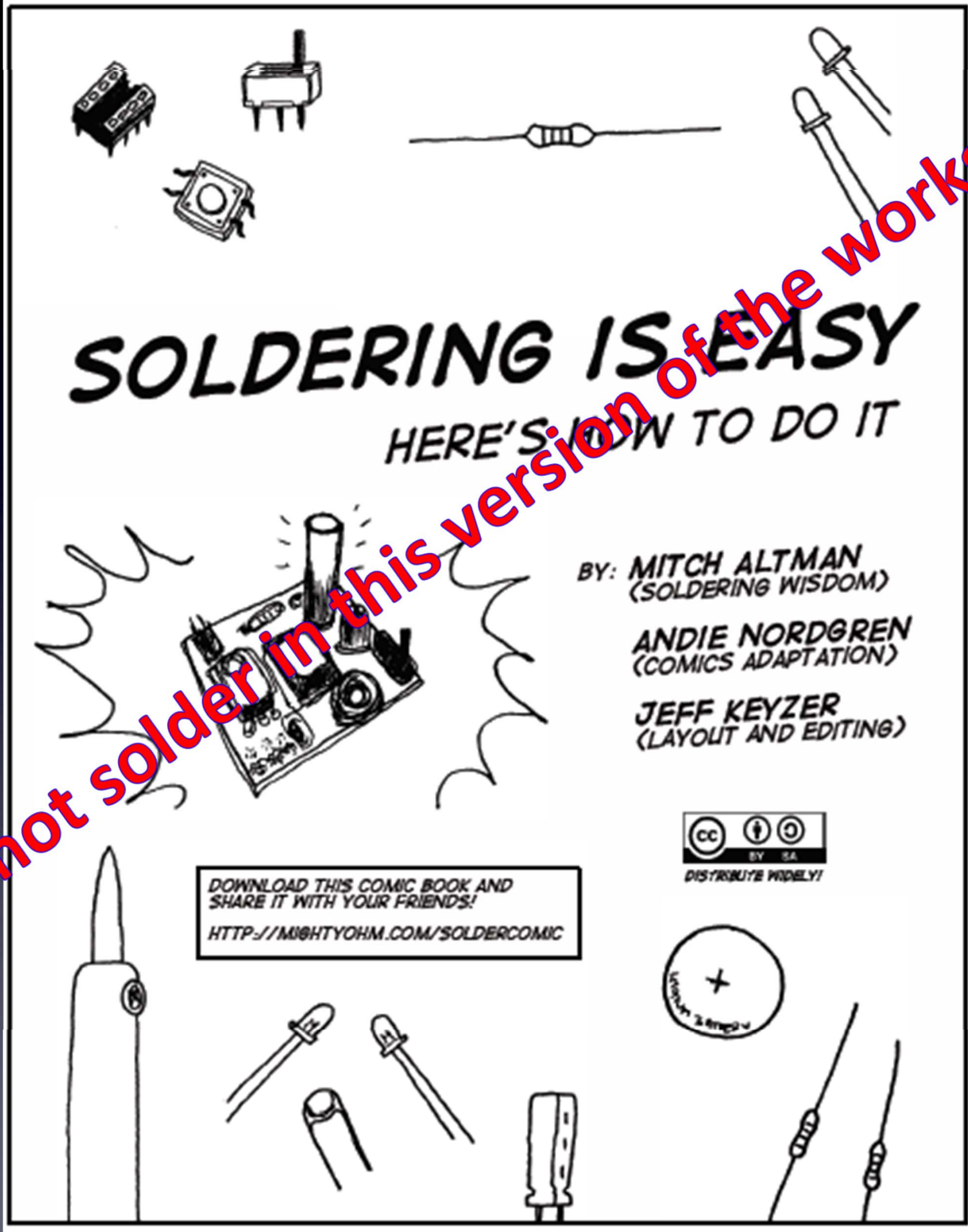

download for free at:

<http://mightyohm.com/soldercomic>

(In many different languages.)

Learn To Solder

SOLDERING IS EASY

HERE'S HOW TO DO IT

BY: MITCH ALTMAN
(SOLDERING WISDOM)

ANDIE NORDGREN
(COMICS ADAPTATION)

JEFF KEYZER
(LAYOUT AND EDITING)



DISTRIBUTE WIDELY!

DOWNLOAD THIS COMIC BOOK AND
SHARE IT WITH YOUR FRIENDS!
[HTTP://MIGHTYOHM.COM/SOLDERCOMIC](http://mightyohm.com/soldercomic)

We will not solder in this version of the workshop
(But, soldering really is easy!)

download for free at:

<http://mightyohm.com/soldercomic>

(In many different languages.)

Learn To Solder

We will not solder in this version of the workshop
(But, soldering really is easy!)

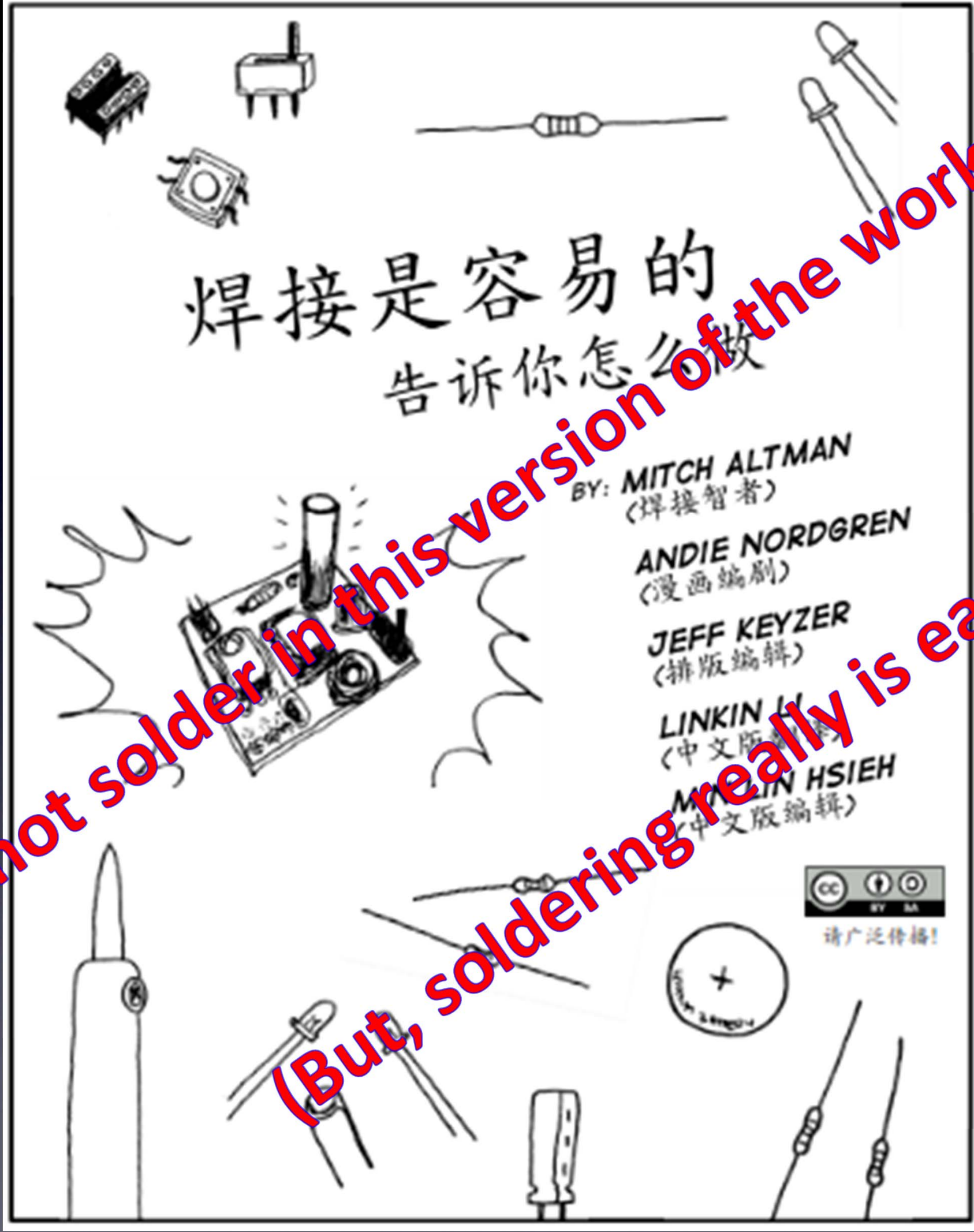

download for free at:

<http://mightyohm.com/soldercomic>

(In many different languages.)

Learn To Solder

We will not solder in this version of the workshop
(But, soldering really is easy!)

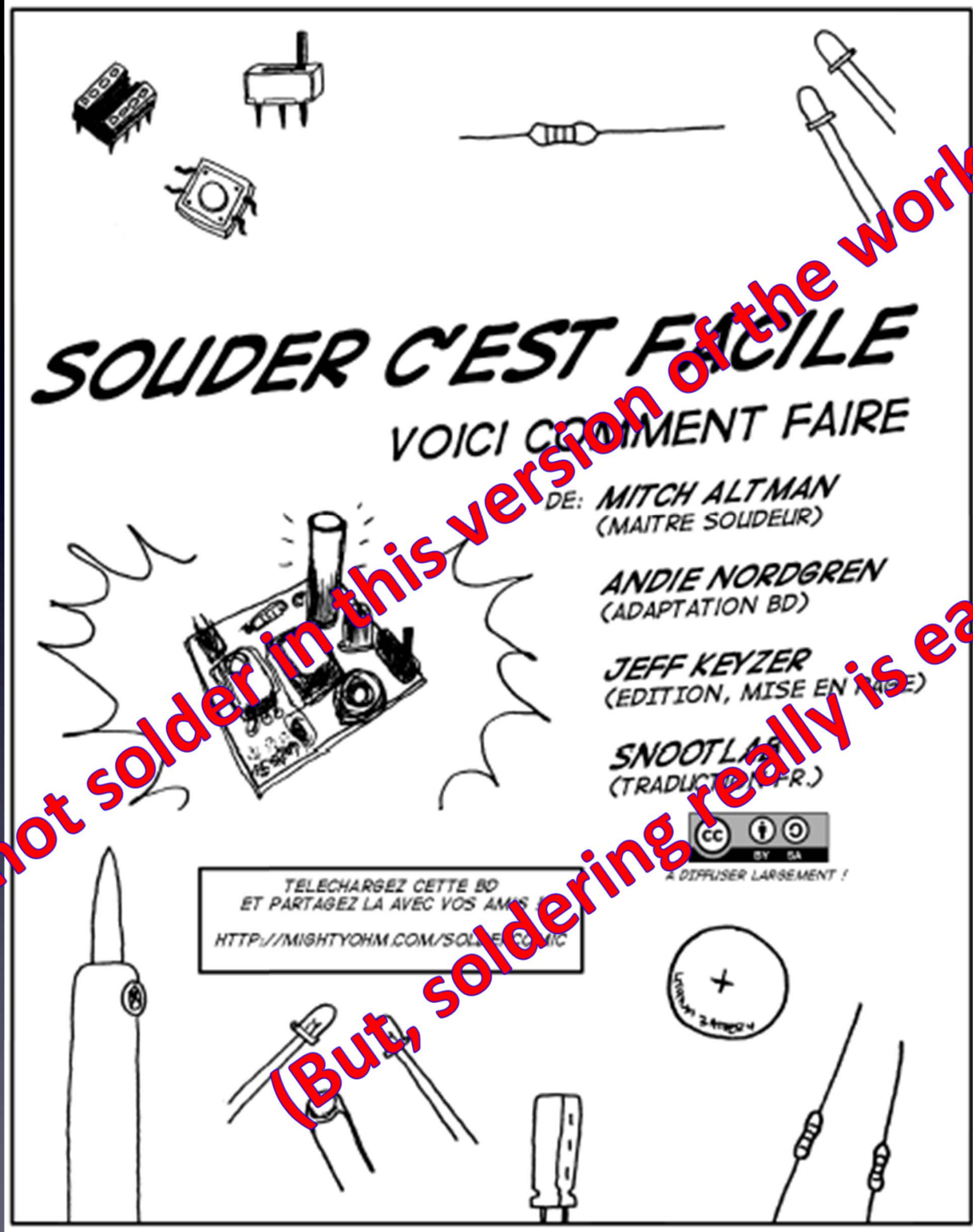

download for free at:

<http://mightyohm.com/soldercomic>

(In many different languages.)

Learn To Solder

SOLDAR ES FÁCIL!

APRENDE COMO HACERLO

POR: MITCH ALTMAN
(SABIDURÍA EN SOLDADO)

ANDIE NORDGREN
(ADAPTACIÓN A COMIC)

JEFF KEYZER
(DISEÑO Y EDICIÓN)



DISTRIBUYE AMPLIAMENTE!

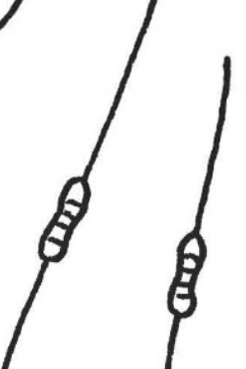
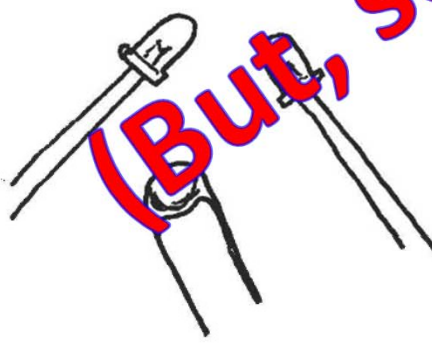
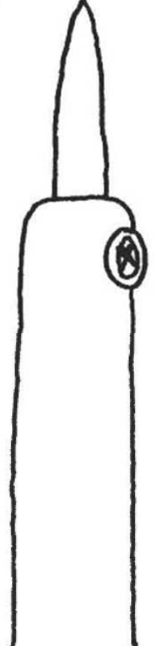
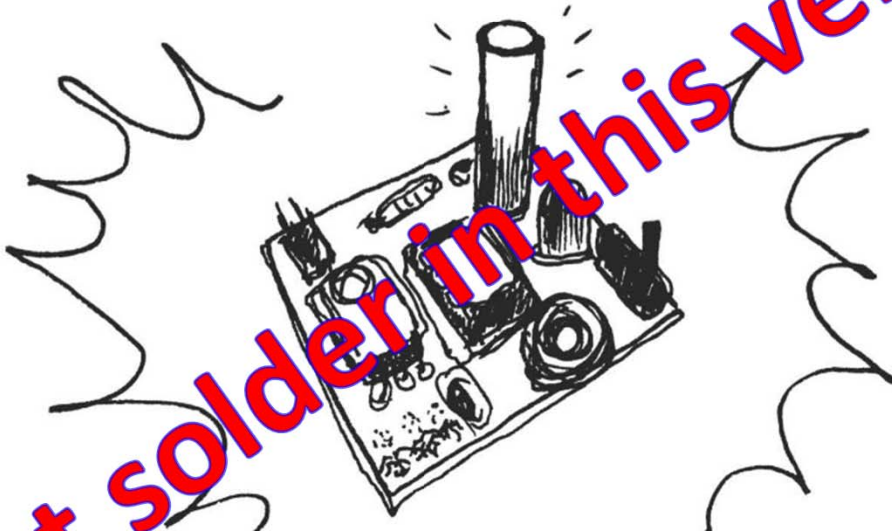
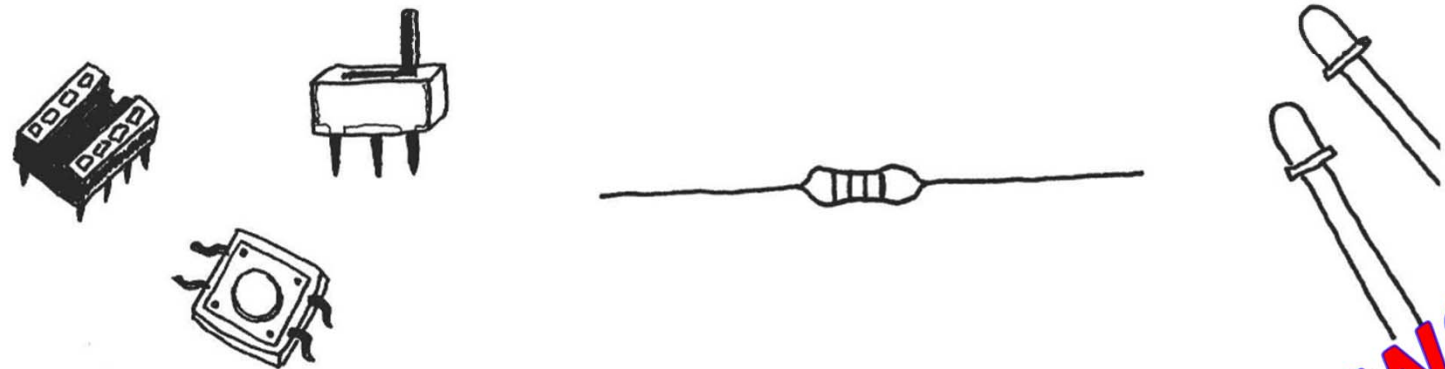

We will not solder in this version of the workshop
(But, soldering really is easy!)

download for free at:

<http://mightyohm.com/soldercomic>

(In many different languages.)

Learn To Solder

We will not solder in this version of the workshop
(But, soldering really is easy!)



download for free at:

<http://mightyohm.com/soldercomic>

(In many different languages.)

We Won't Solder Our Own Arduino Clone

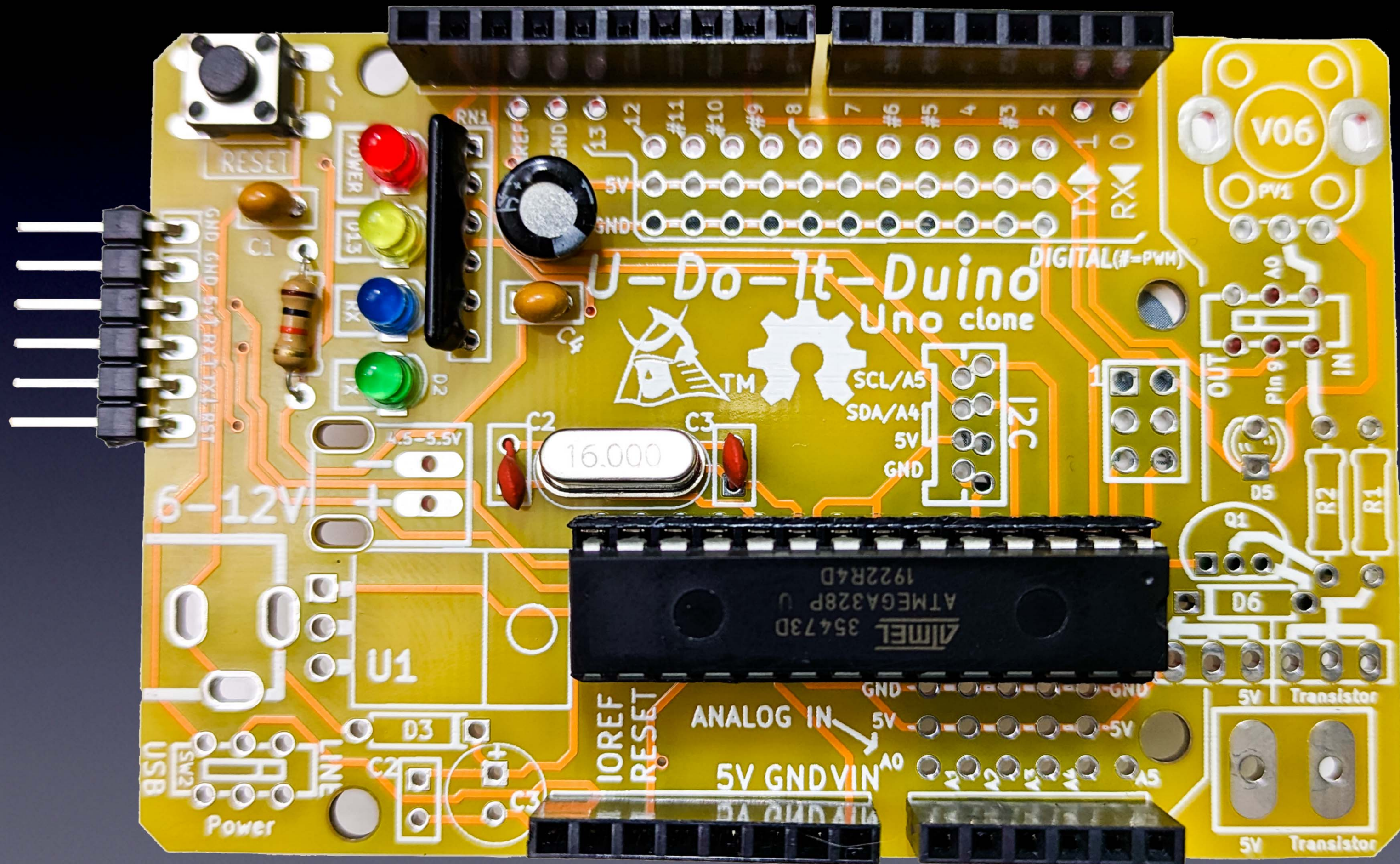

We will use a ready-made Arduino “Clone”

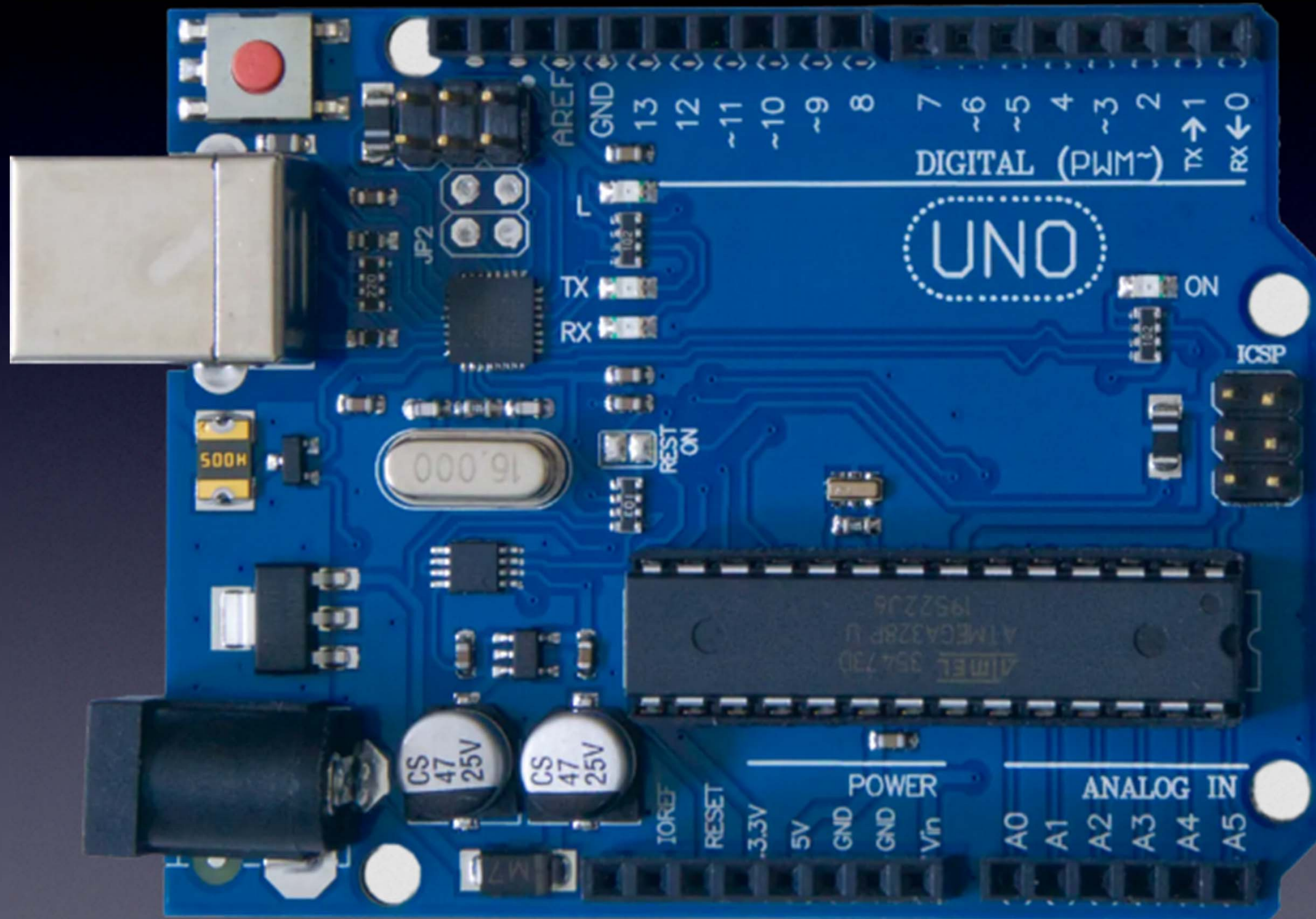

Uno clone

We will use a ready-made Arduino “Clone”

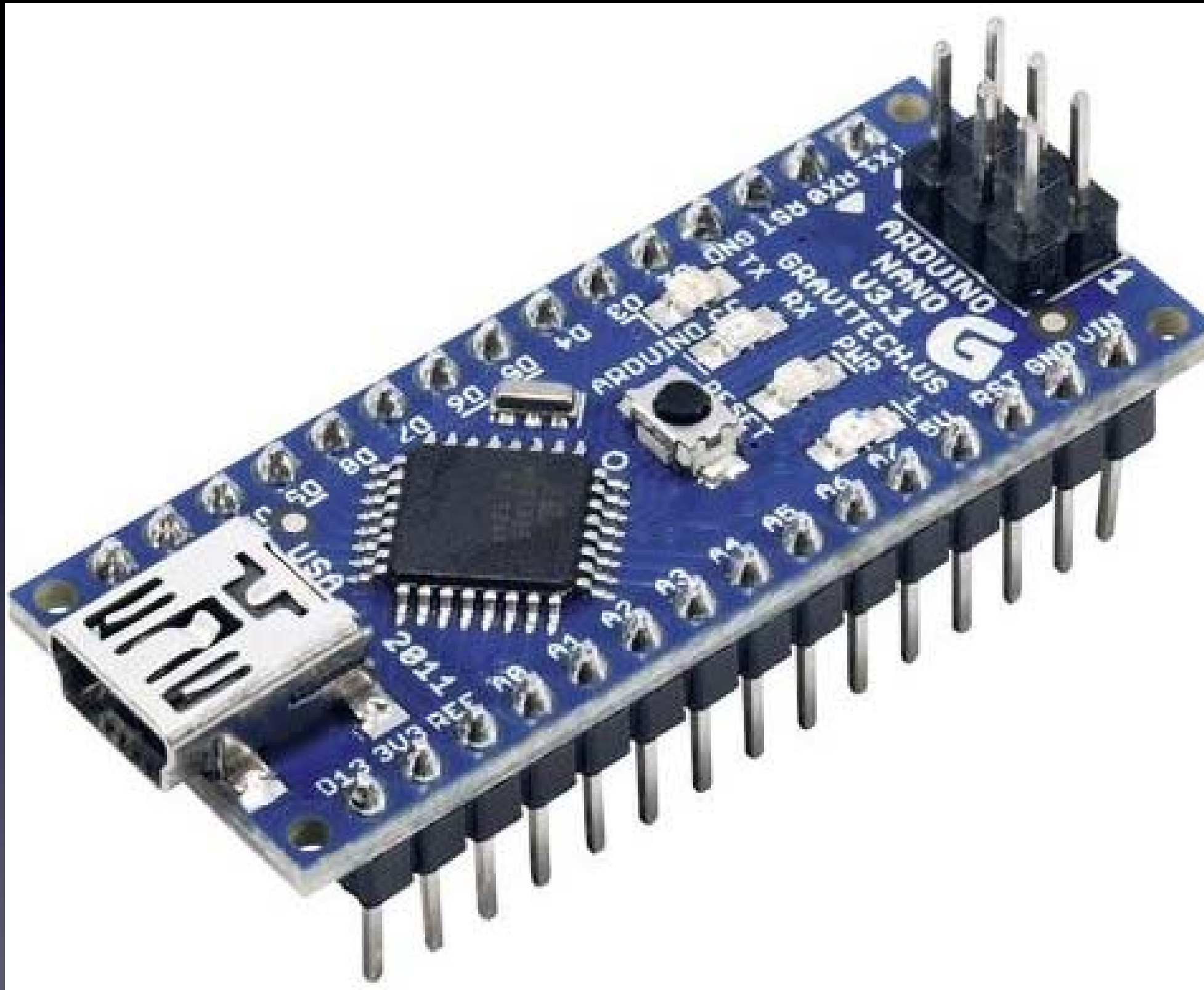

Nano clone

How to Set Up and Use the Arduino Software



The screenshot displays the Arduino IDE 2.1.0 interface. The window title is "sketch_may1a | Arduino IDE 2.1.0". The menu bar includes "File", "Edit", "Sketch", "Tools", and "Help". The toolbar shows a checkmark, a right arrow, and a play button, with a dropdown menu set to "Arduino Uno". The main editor area shows the following code in "sketch_may1a.ino":

```
1 void setup() {  
2   // put your setup code here, to run once:  
3  
4 }  
5  
6 void loop() {  
7   // put your main code here, to run repeatedly:  
8  
9 }  
10
```

The status bar at the bottom right indicates "Ln 1, Col 1" and "Arduino Uno [not connected]".

How to Hack Arduino Programs (“Sketches”)

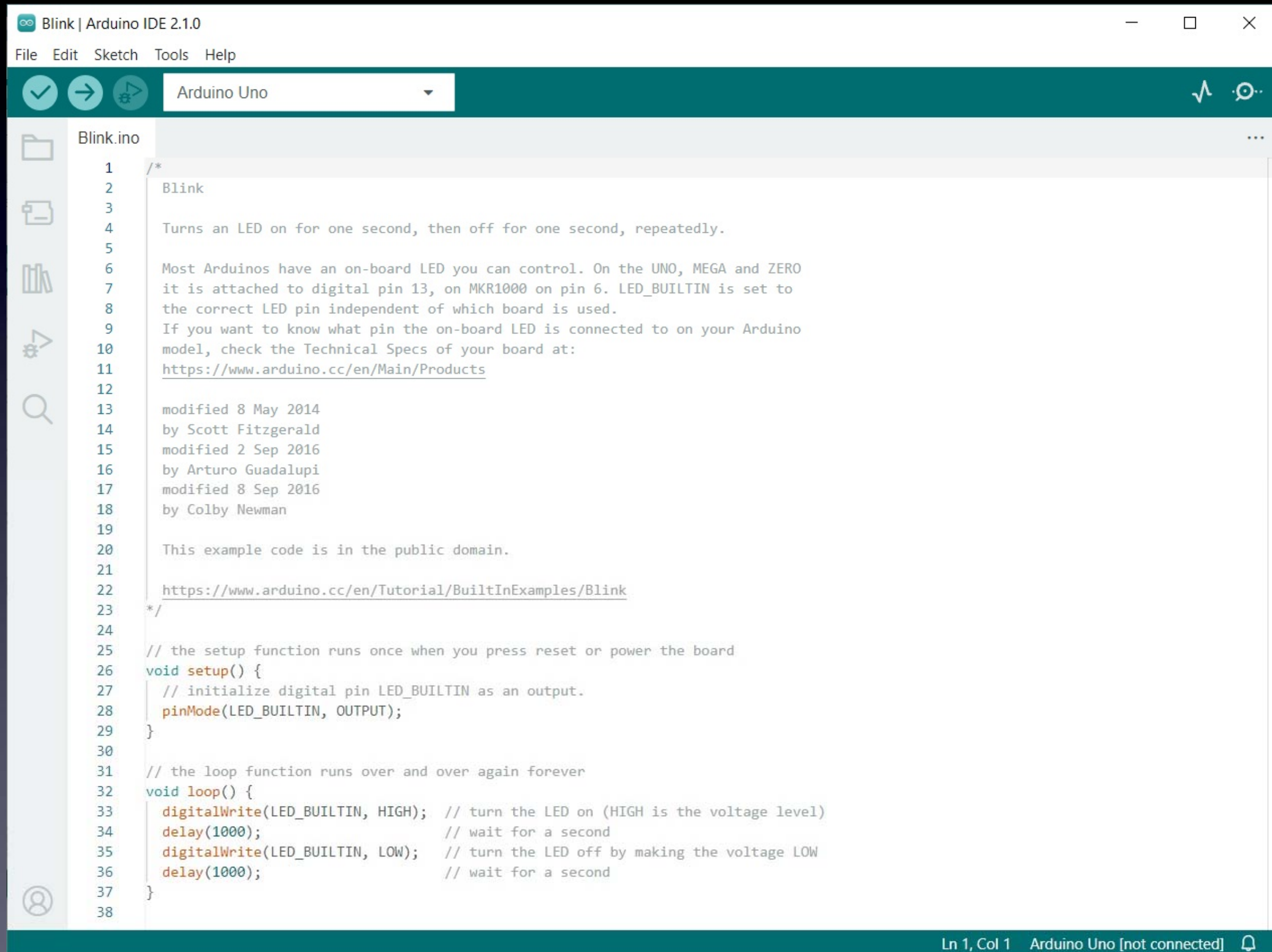

```
1  /*
2  Blink
3
4  Turns an LED on for one second, then off for one second, repeatedly.
5
6  Most Arduinos have an on-board LED you can control. On the UNO, MEGA and ZERO
7  it is attached to digital pin 13, on MKR1000 on pin 6. LED_BUILTIN is set to
8  the correct LED pin independent of which board is used.
9  If you want to know what pin the on-board LED is connected to on your Arduino
10 model, check the Technical Specs of your board at:
11 https://www.arduino.cc/en/Main/Products
12
13 modified 8 May 2014
14 by Scott Fitzgerald
15 modified 2 Sep 2016
16 by Arturo Guadalupi
17 modified 8 Sep 2016
18 by Colby Newman
19
20 This example code is in the public domain.
21
22 https://www.arduino.cc/en/Tutorial/BuiltInExamples/Blink
23 */
24
25 // the setup function runs once when you press reset or power the board
26 void setup() {
27   // initialize digital pin LED_BUILTIN as an output.
28   pinMode(LED_BUILTIN, OUTPUT);
29 }
30
31 // the loop function runs over and over again forever
32 void loop() {
33   digitalWrite(LED_BUILTIN, HIGH); // turn the LED on (HIGH is the voltage level)
34   delay(1000); // wait for a second
35   digitalWrite(LED_BUILTIN, LOW); // turn the LED off by making the voltage LOW
36   delay(1000); // wait for a second
37 }
38
```

Ln 1, Col 1 Arduino Uno [not connected]

How to Use Solderless Breadboards

Solderless Breadboard

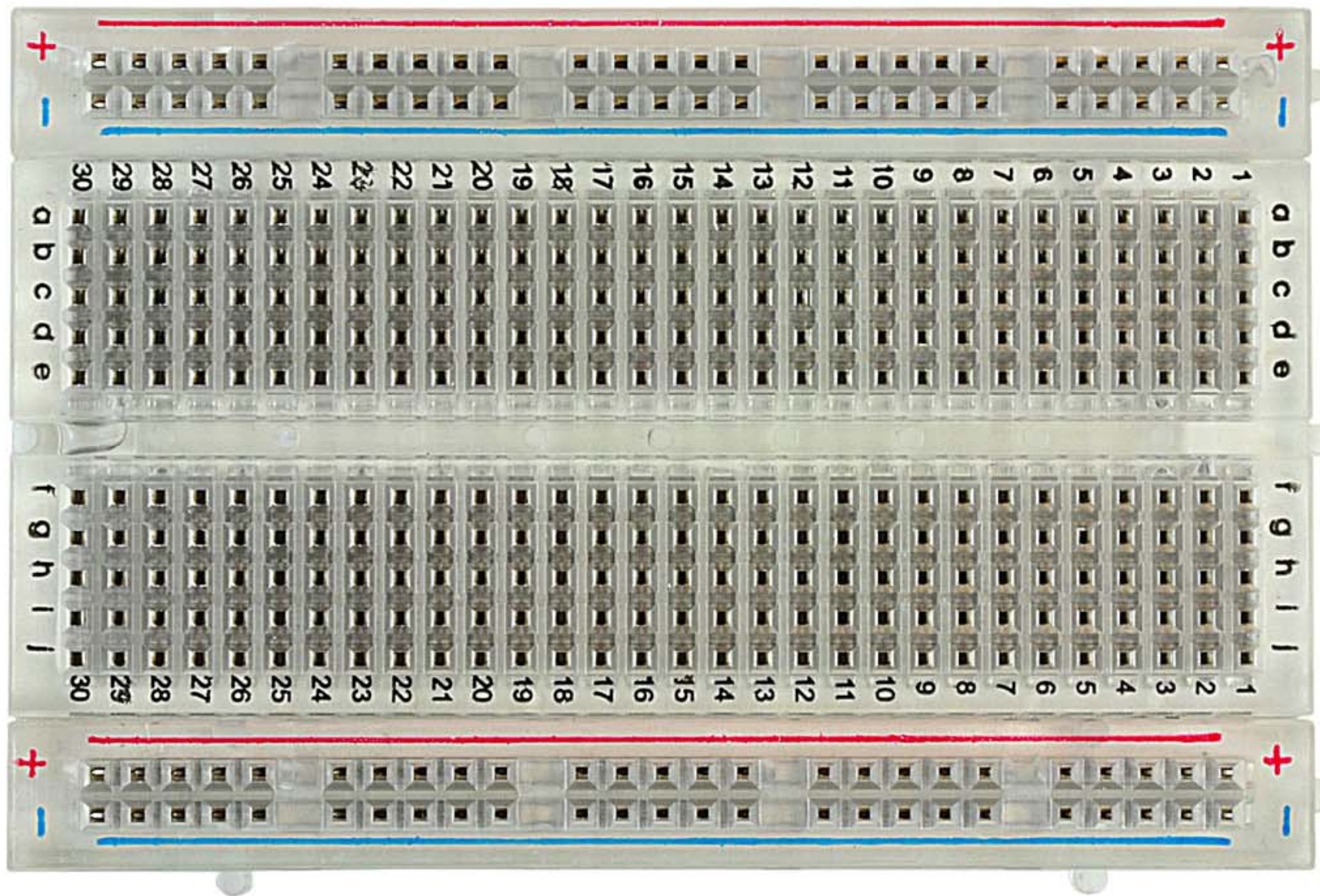

How to Use Solderless Breadboards

Solderless Breadboard with LED and wires

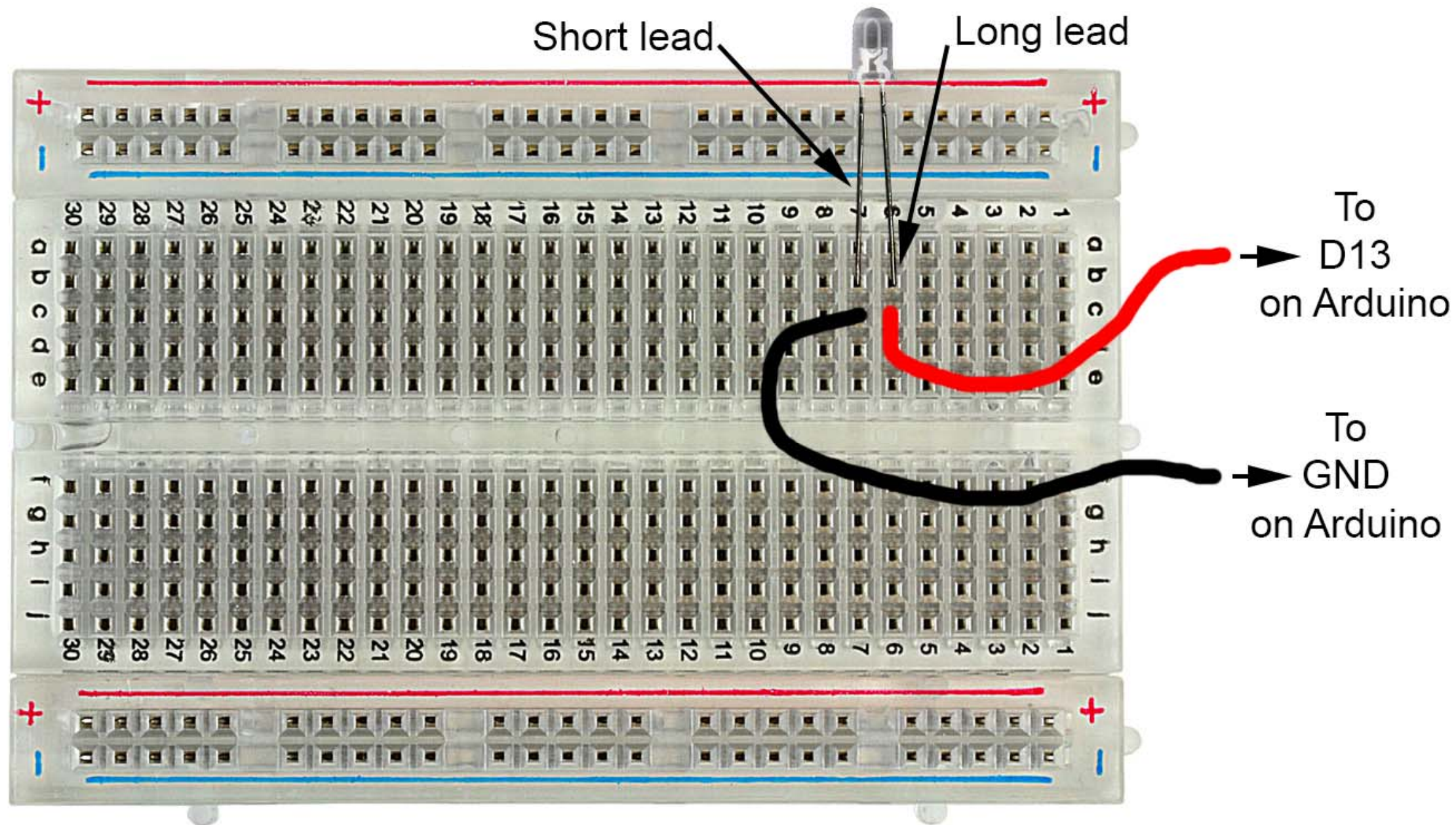

How to Read a Schematic

Arduino For Total Newbies

4-Sep-2015

Mitch Altman (original TV-B-Gone hardware and firmware, modified TV-B-Gone Arduino design)
Limore Fried (firmware modifications, kit design)
Ken Shirriff (original modifications for Arduino)
Johannes Schneemann (documentation)

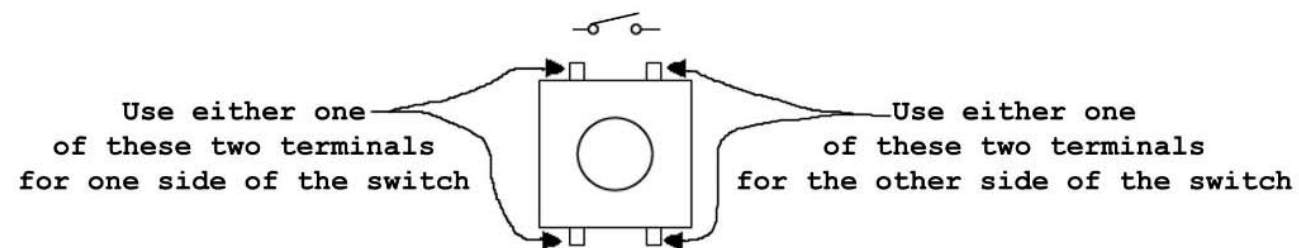
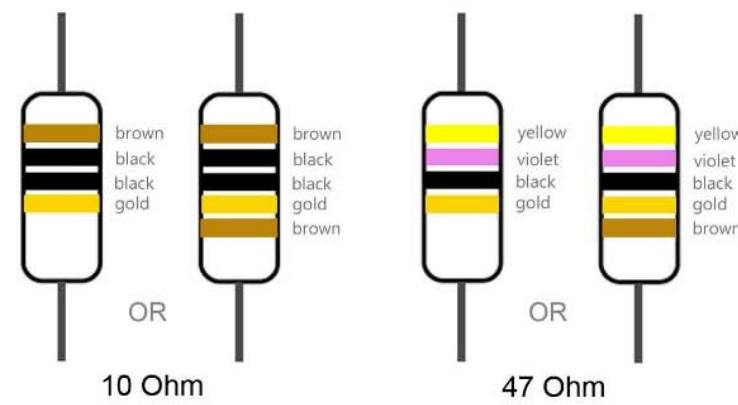
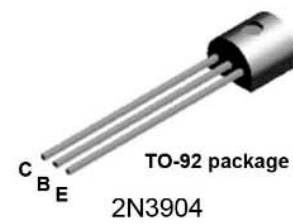
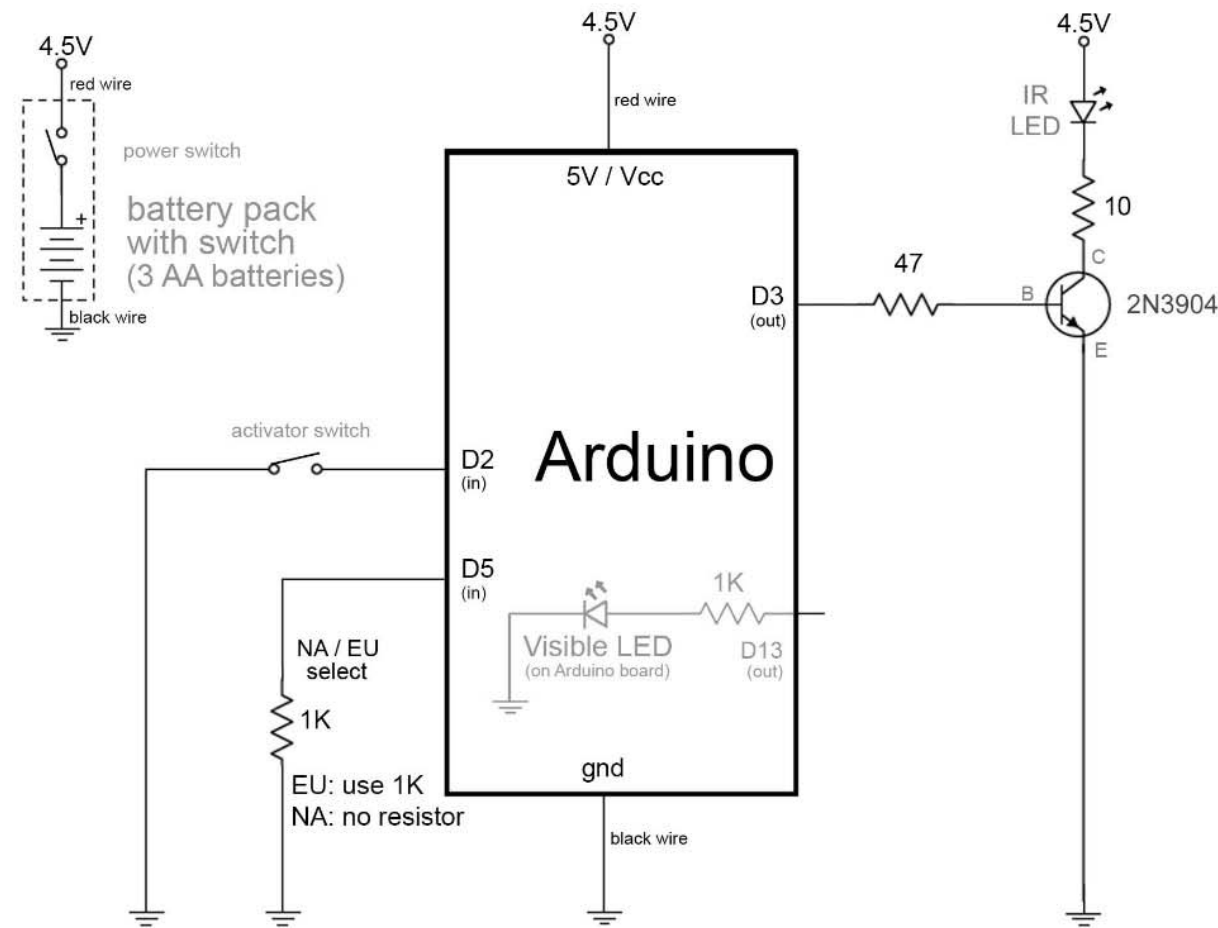

Make a TV-B-Gone Remote Control with your Arduino Clone without soldering

Solderless Breadboard with parts & wires for TV-B-Gone

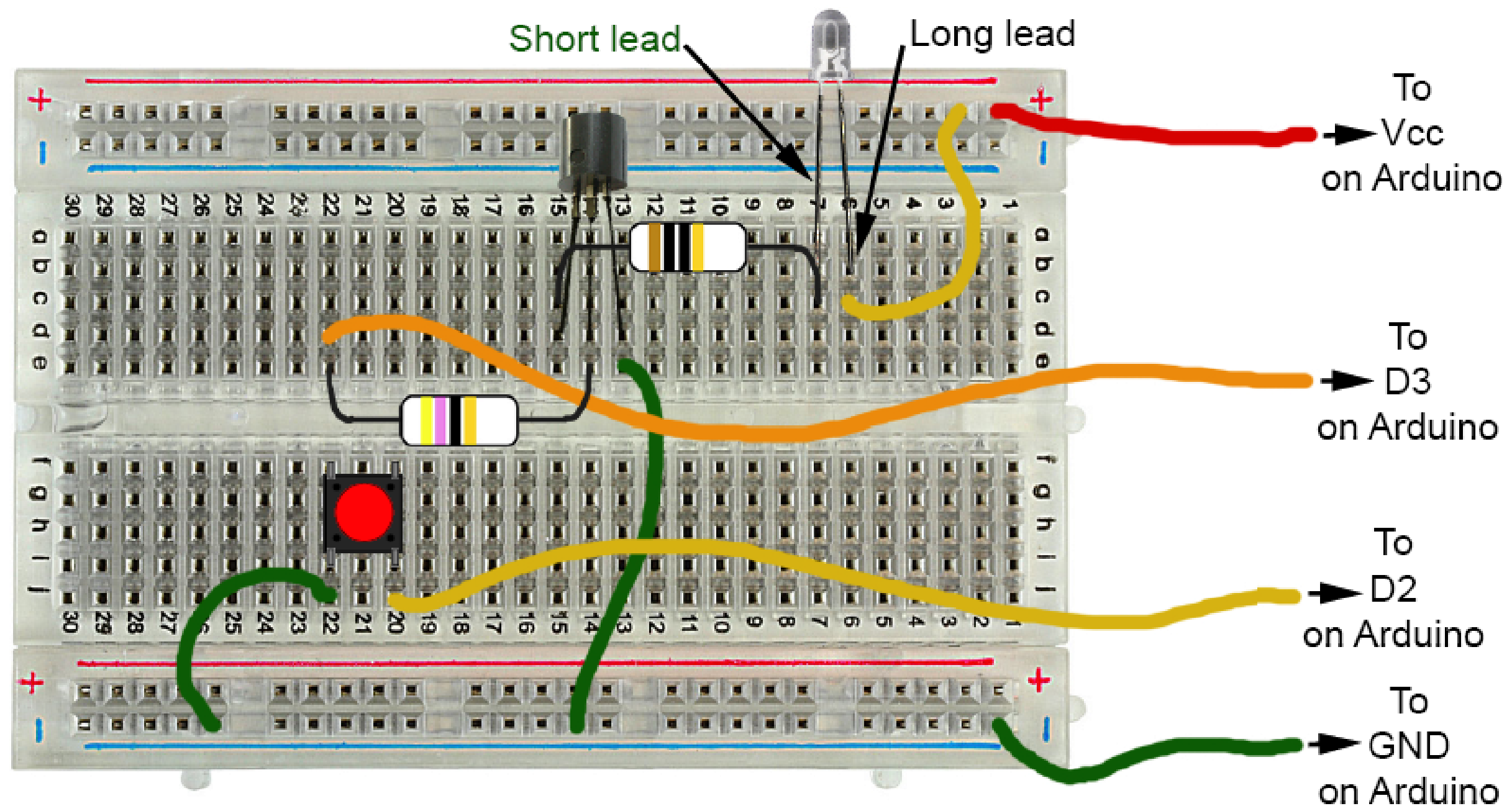

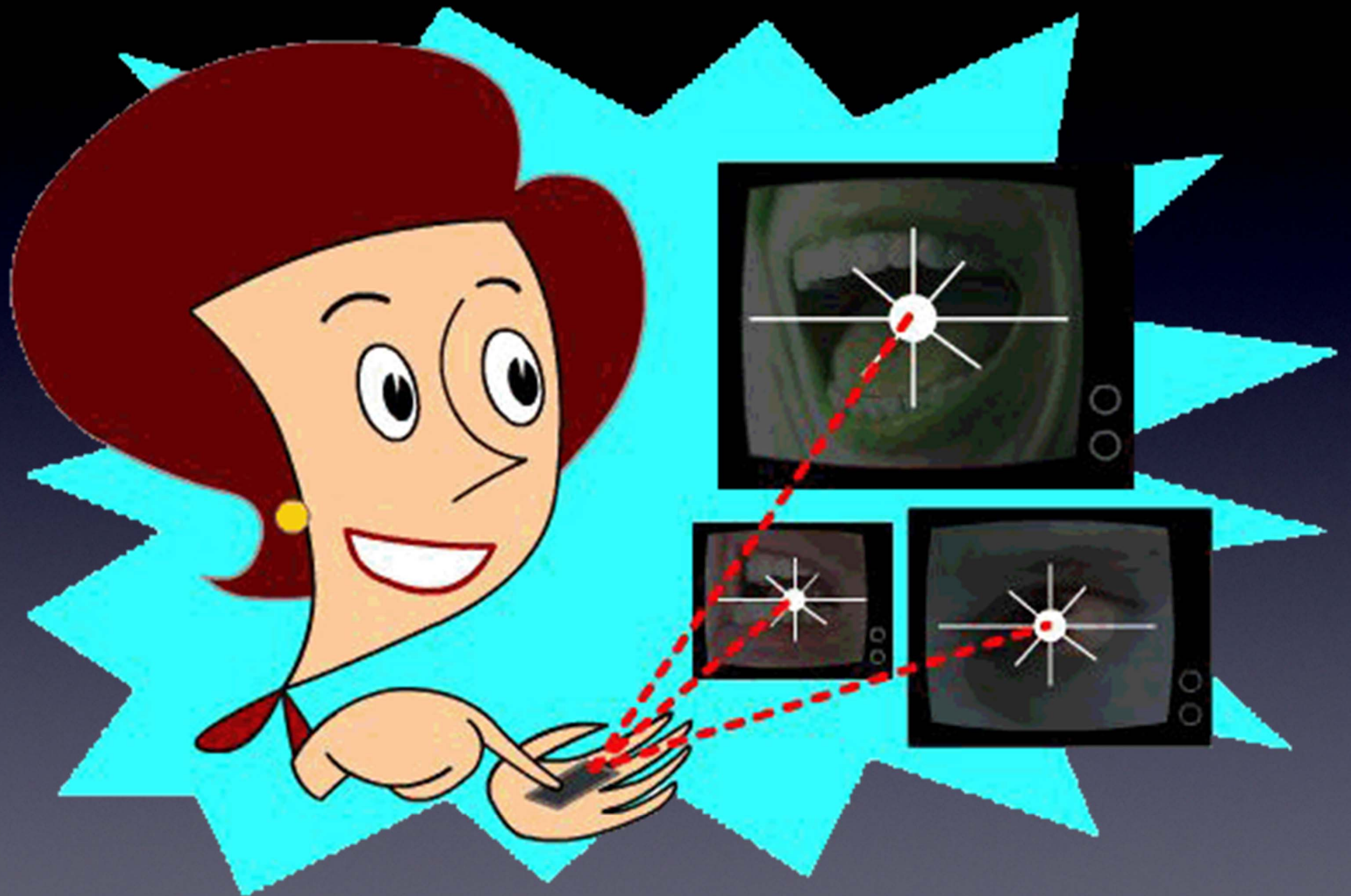

Questions?

Intro

Intro



Intro



Arduino For Total Newbies Workshop at 30C3, Hamburg Germany

Intro to Arduino



Intro to Arduino: microcontrollers

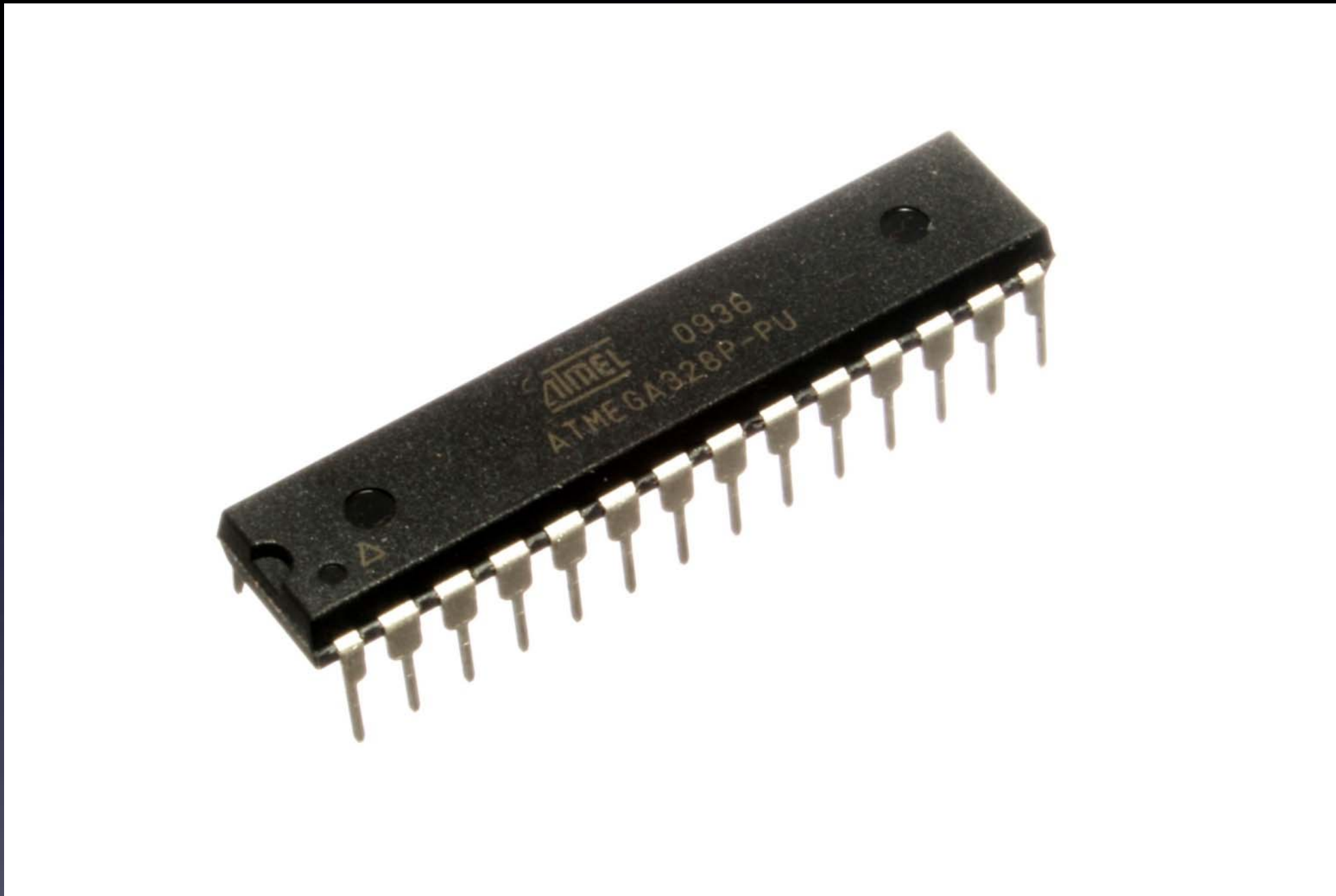

A complete computer on a chip

Intro to Arduino: microcontrollers

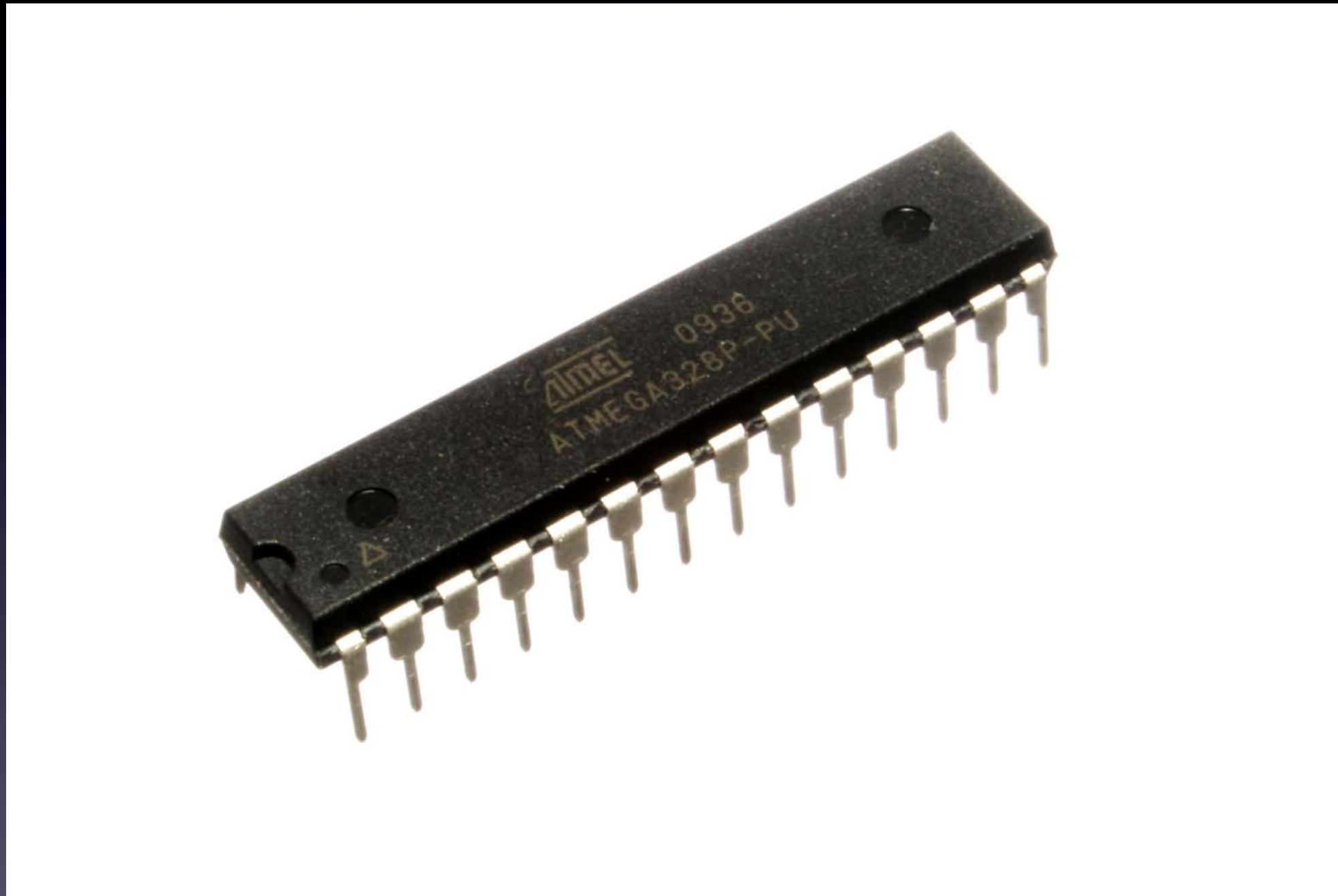

A complete computer on a chip:
they control parts connected to their pins

Intro to Arduino: microcontrollers

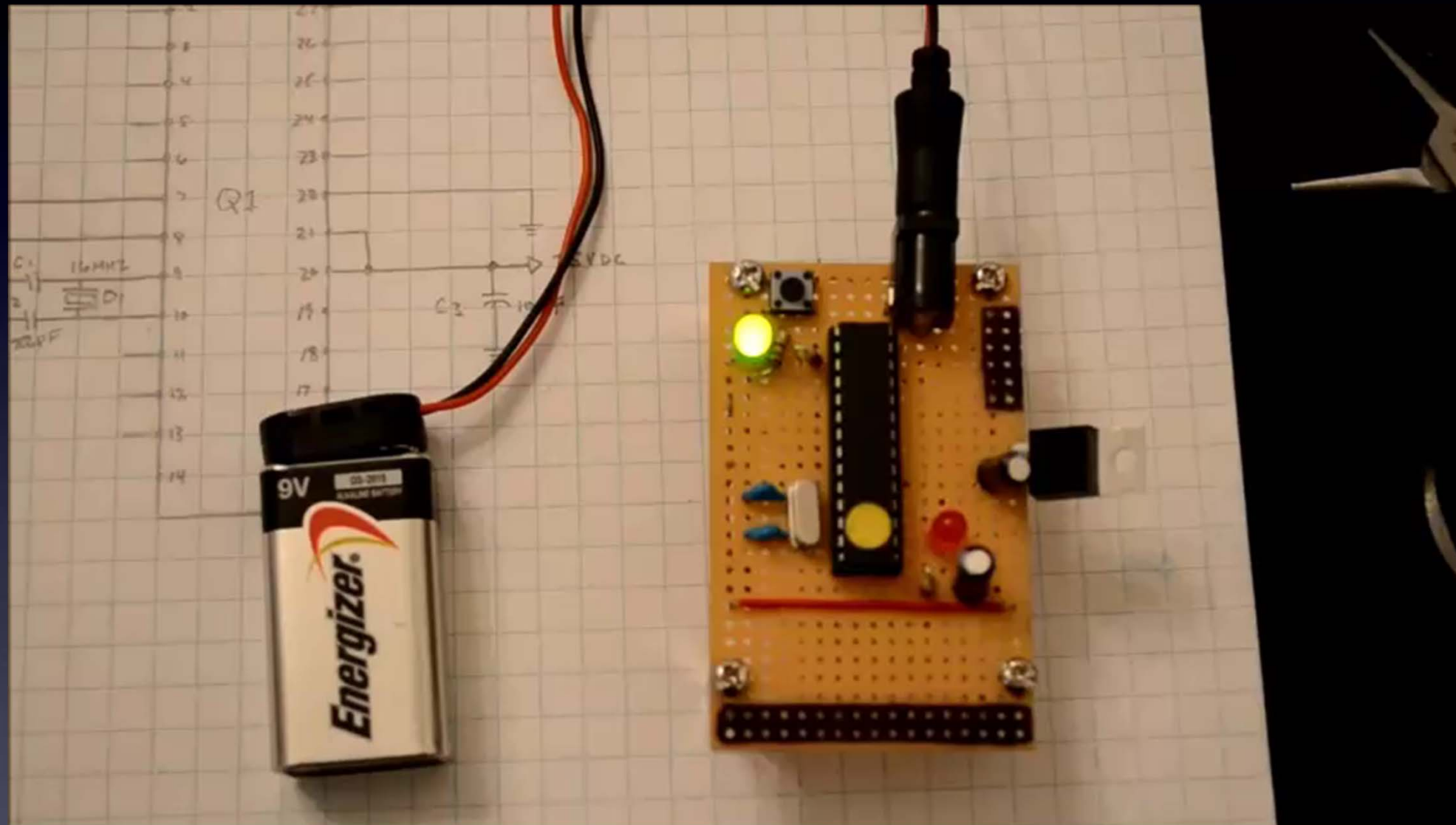

Intro to Arduino: microcontrollers

-- one of Mitch's projects --

*ArduTouch
music
synthesizer
kit*

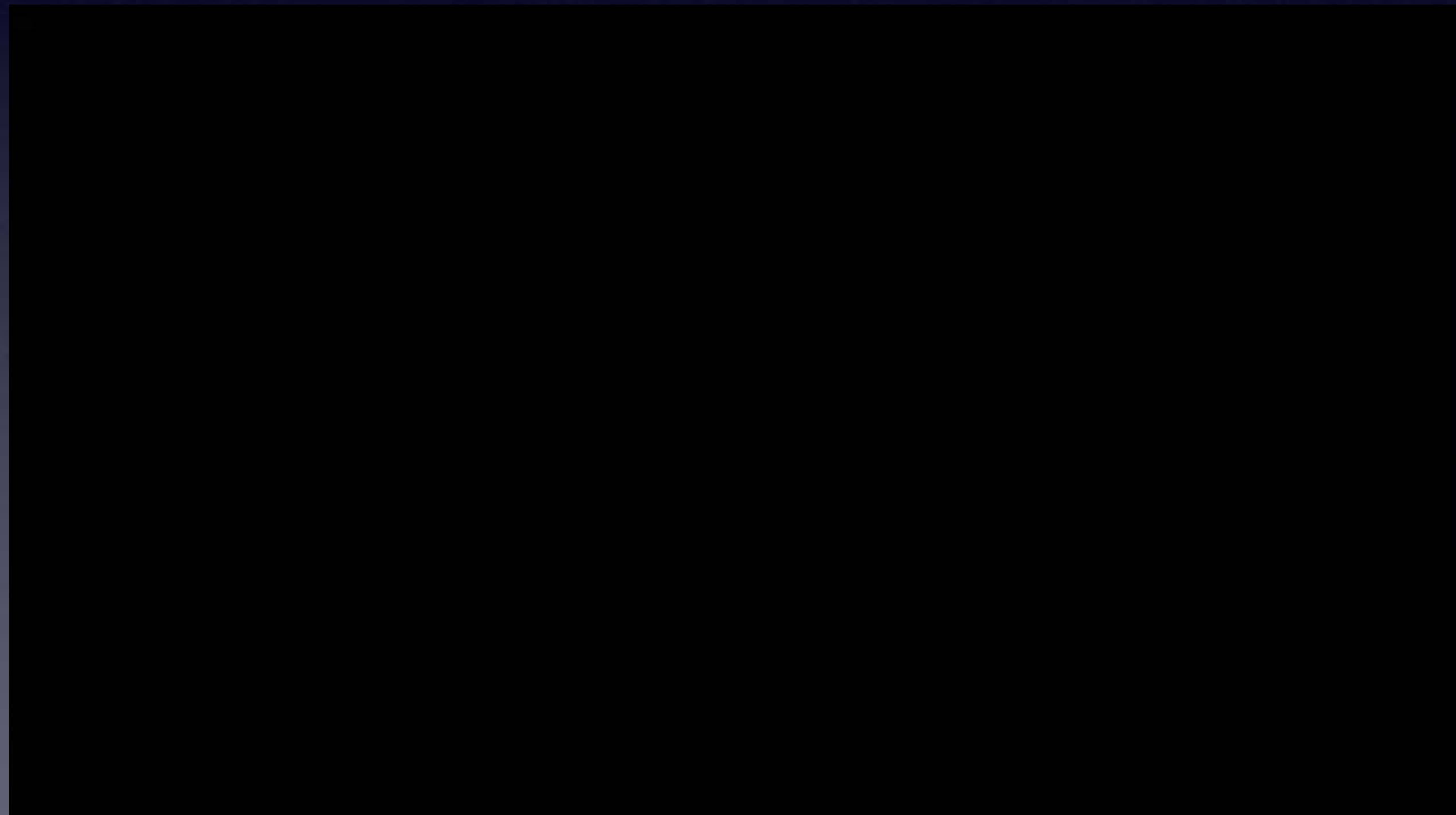

Intro to Arduino: microcontrollers



Intro to Arduino: microcontrollers



Intro to Arduino: microcontrollers



Intro to Arduino: microcontrollers



Intro to Arduino: microcontrollers

-- *one of Mitch's projects* --

TV-B-Gone



Intro to Arduino: microcontrollers

-- one of Mitch's projects --



TV-B-Gone

*Just a remote control,
but only one button:*

OFF !



Intro to Arduino:
microcontrollers
-- one of Mitch's projects --

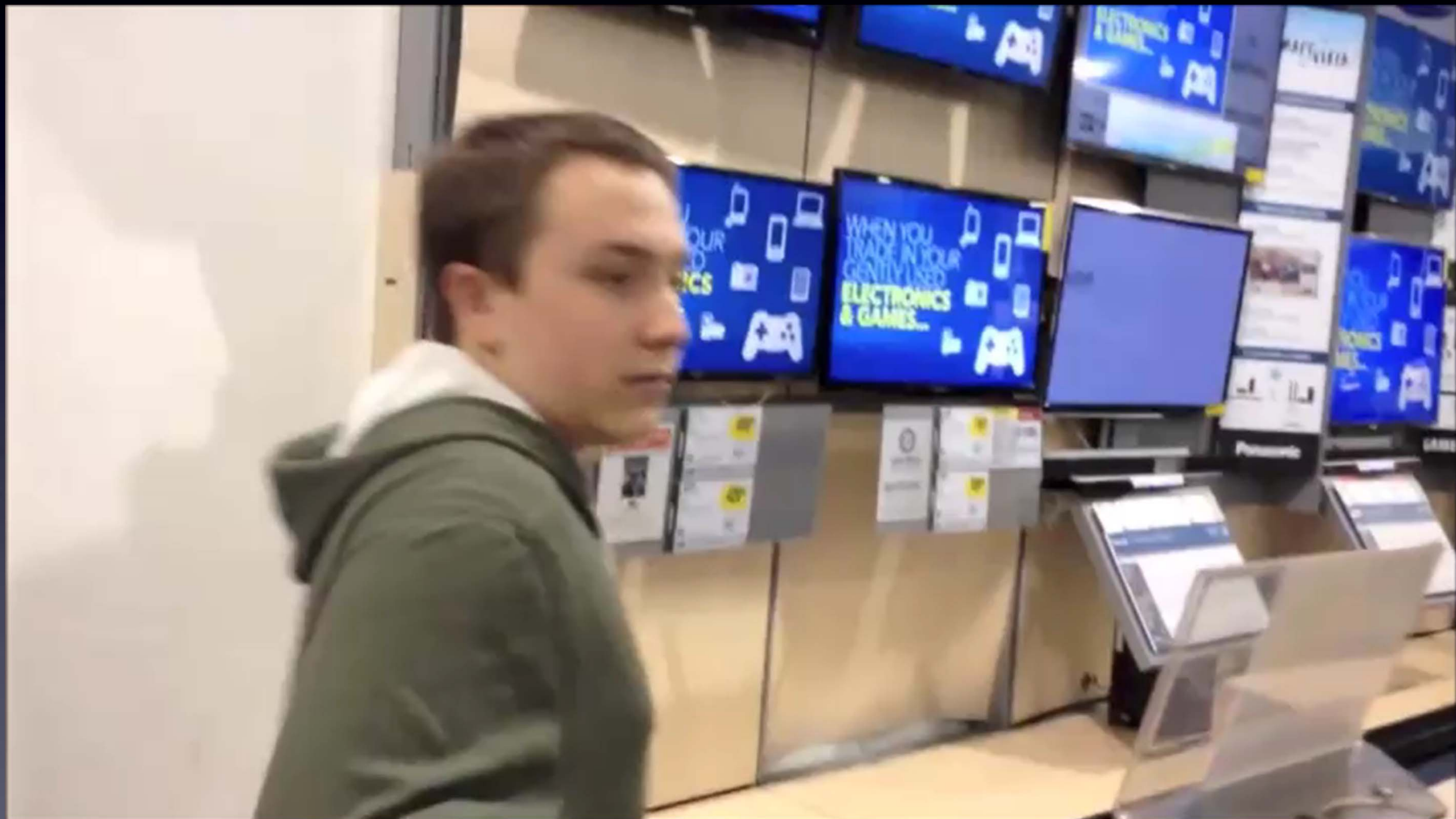

TV-B-Gone

Intro to Arduino: microcontrollers

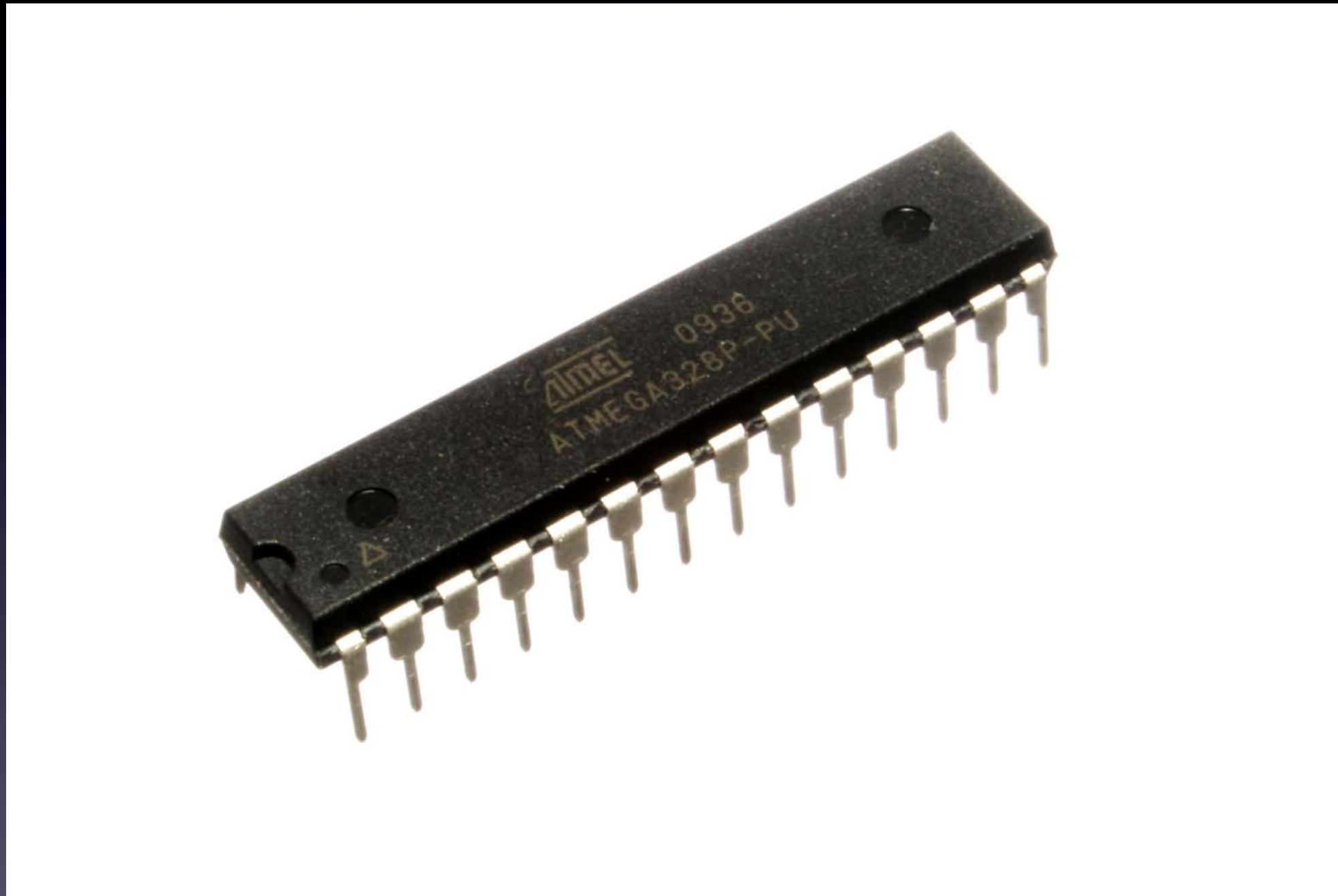

A complete computer on a chip:
they control parts connected to their pins

Intro to Arduino: microcontrollers

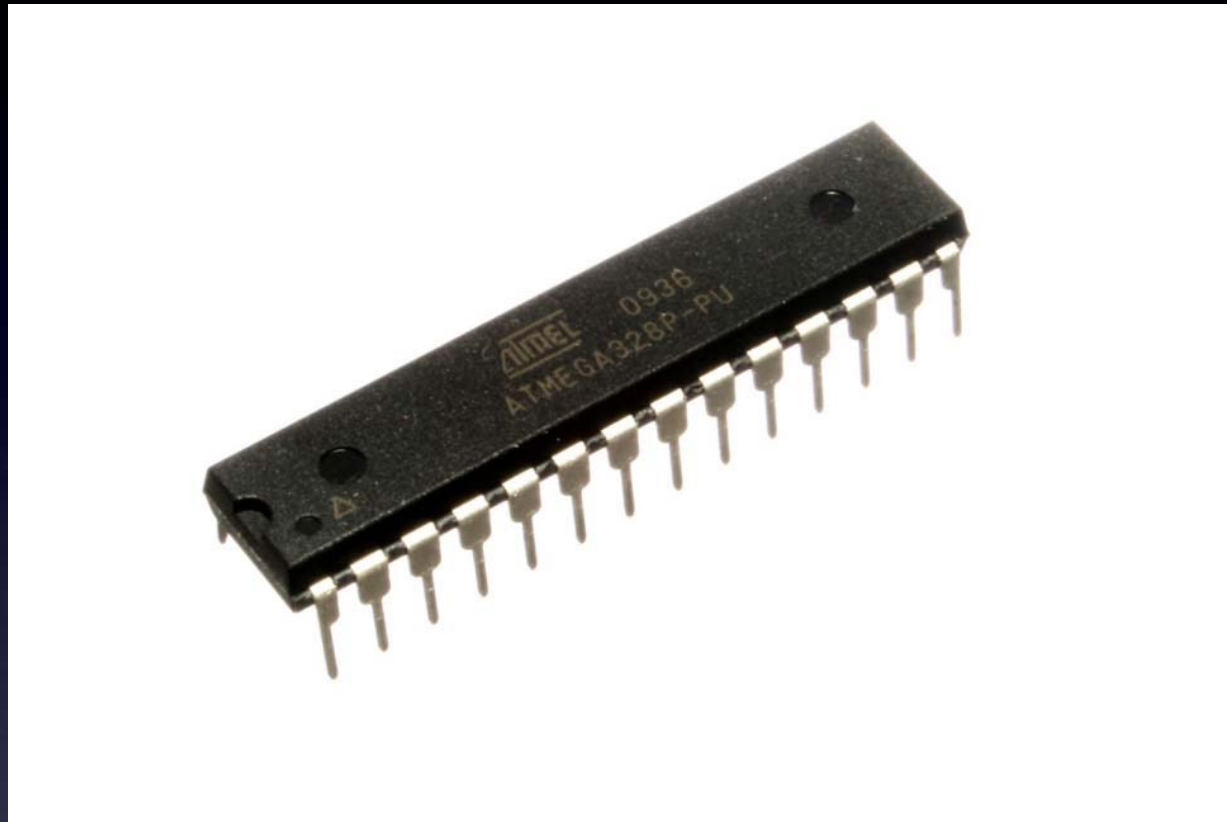

A complete computer on a chip:

they control parts connected to their pins

But,

How do you
connect parts to its pins?

How do you
create and upload a program
to control the parts?

Intro to Arduino: microcontrollers

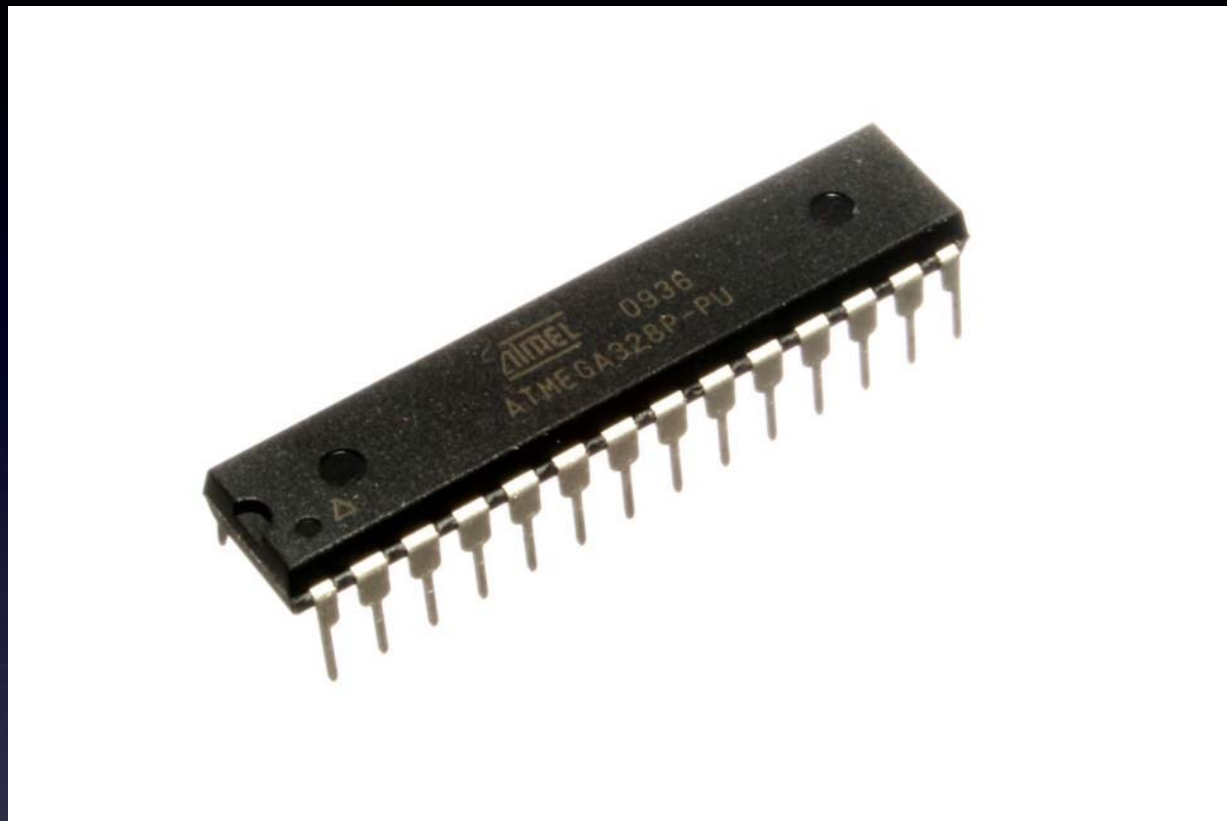

A complete computer on a chip:

they control parts connected to their pins

But,

How do you
connect parts to its pins?

How do you
create and upload a program
to control the parts?

Answer: *Be a geek, and learn how!*

Or

Intro to Arduino



Use an Arduino board

Intro to Arduino



Super easy to connect parts to its microcontroller's pins

Use an Arduino board

Intro to Arduino



Super easy to connect parts to its microcontroller's pins

Use an Arduino board

Super easy to create and upload a program to control the parts

Intro to Arduino



Arduino board

Designed for
non-geeky artists

Intro to Arduino

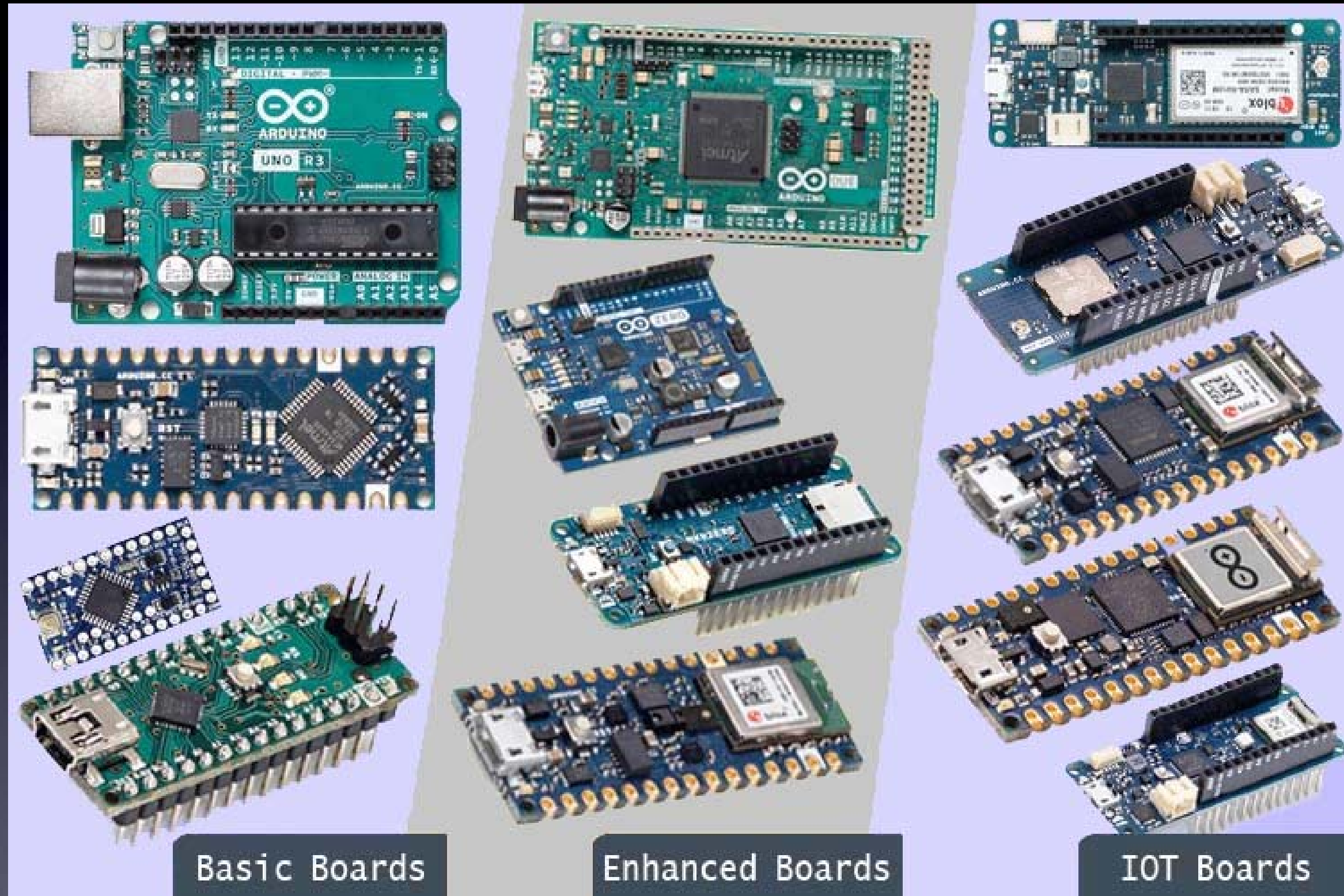

Many Arduino boards to choose from

Intro to Arduino

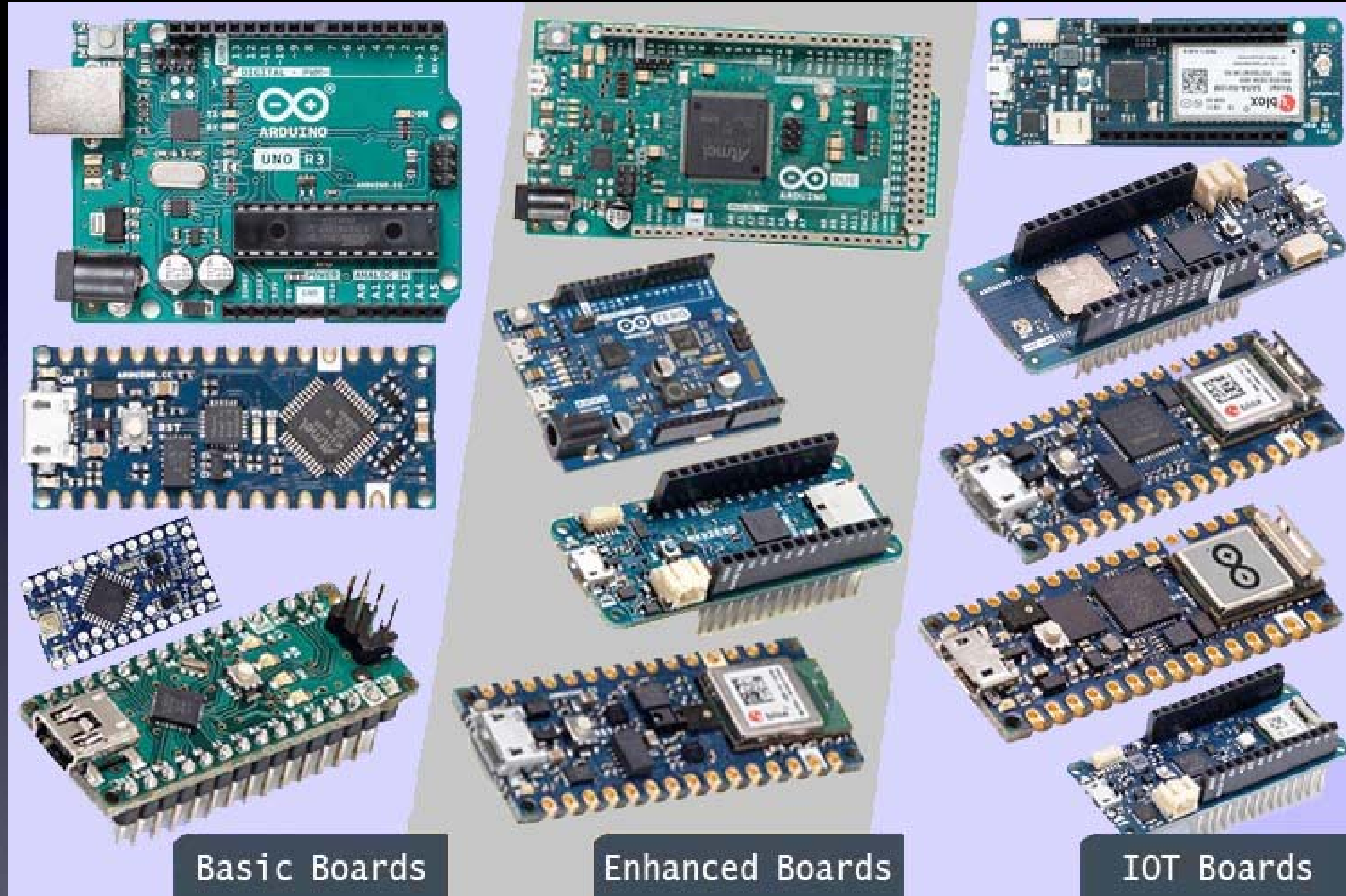

Basic Boards

Enhanced Boards

IOT Boards



Open Source

Intro to Arduino

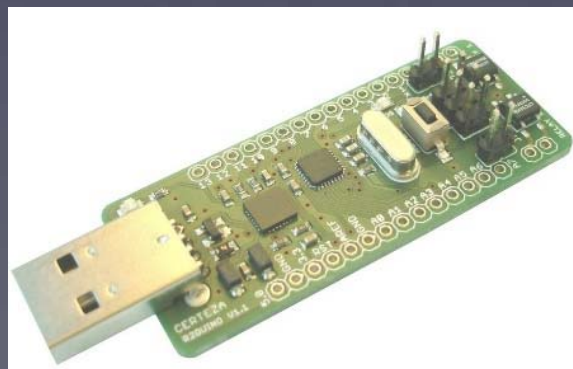
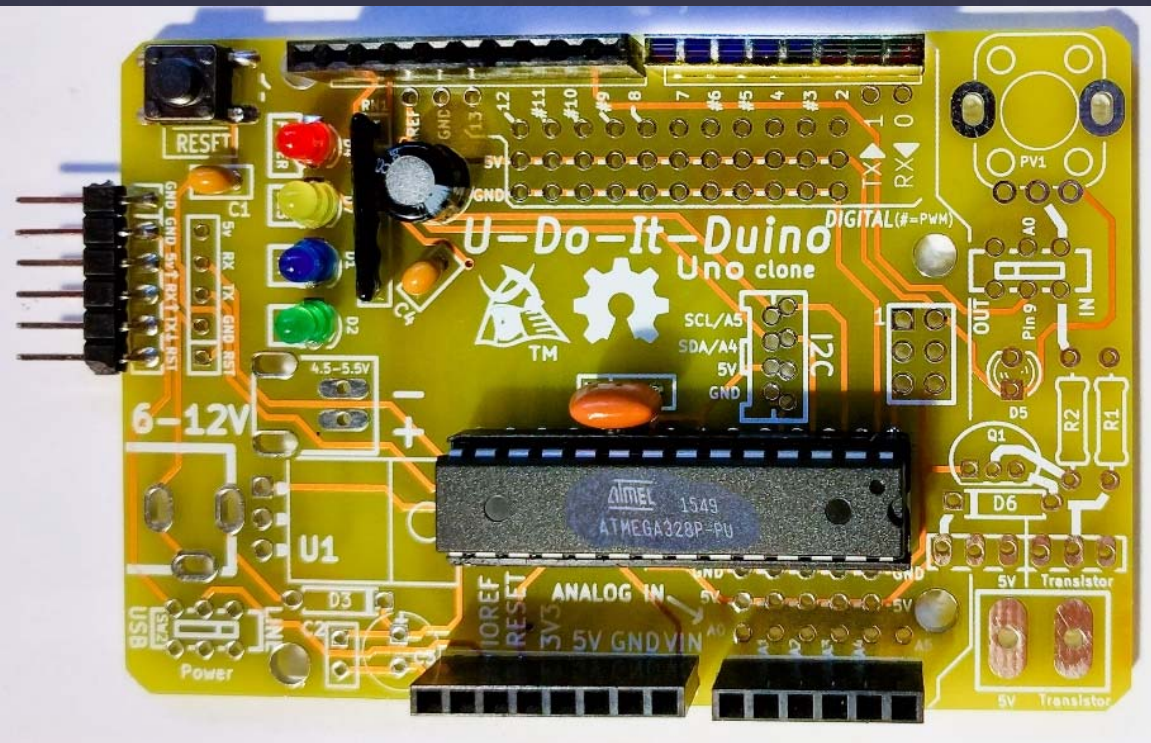
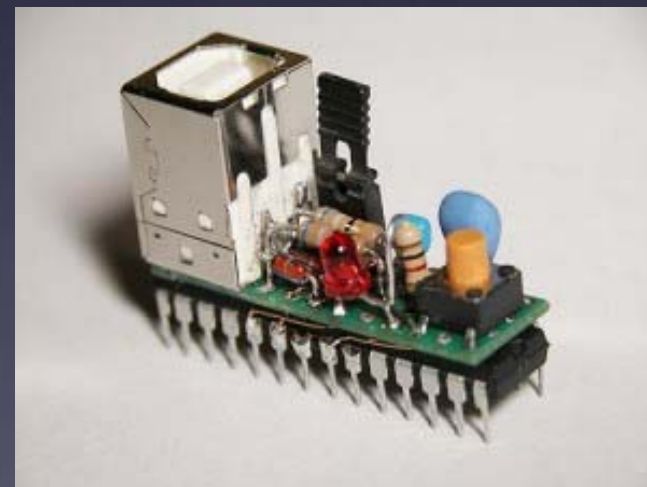
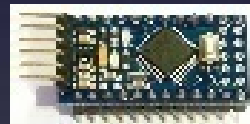
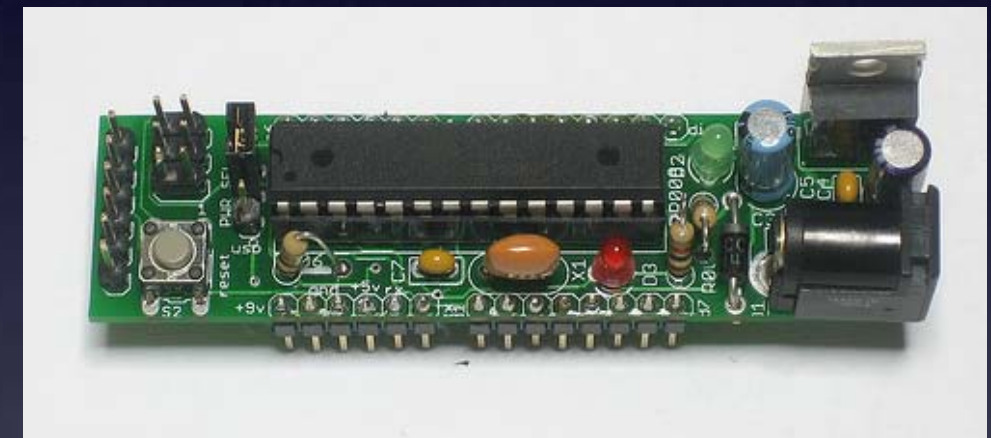
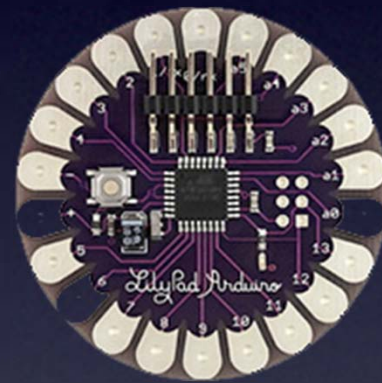
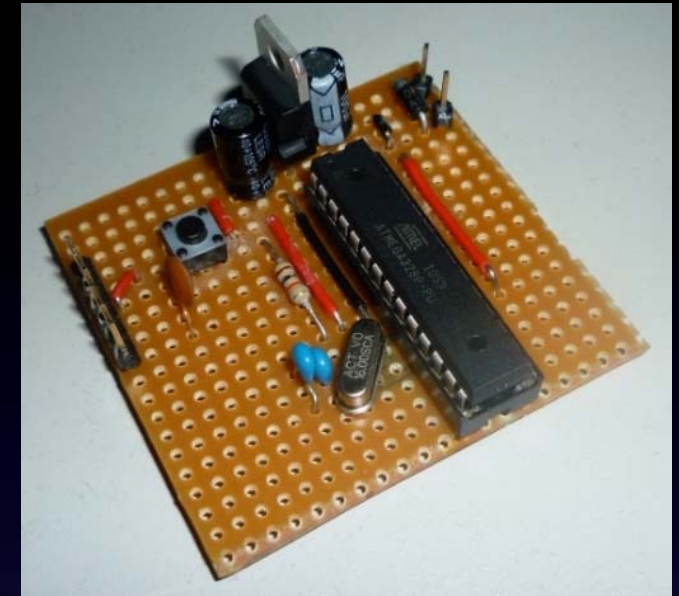
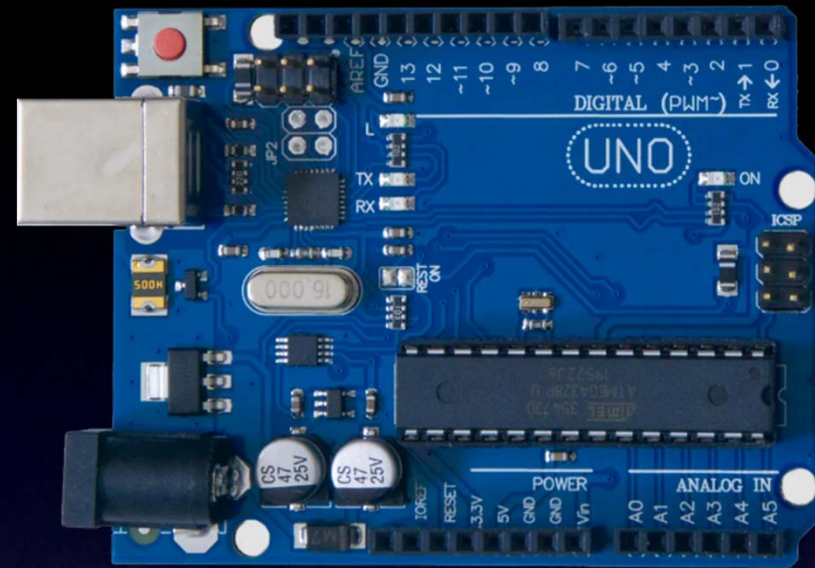
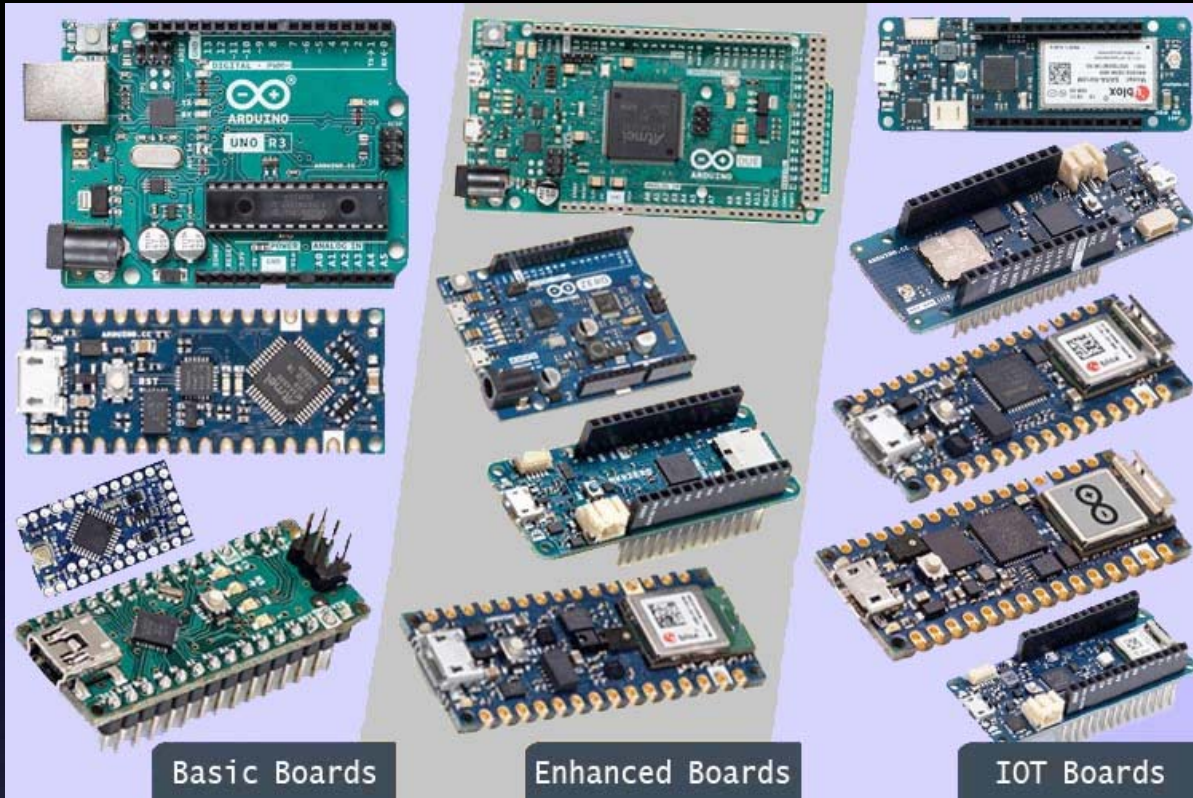

Open Source

Intro to Arduino

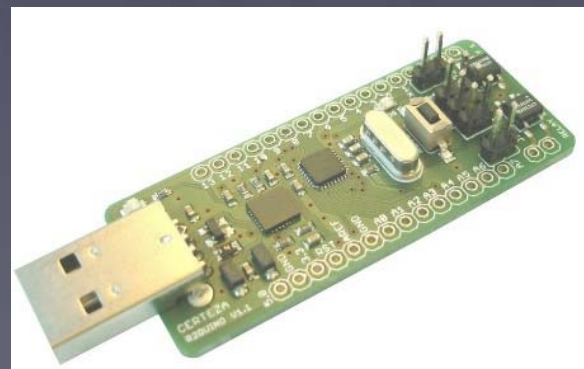
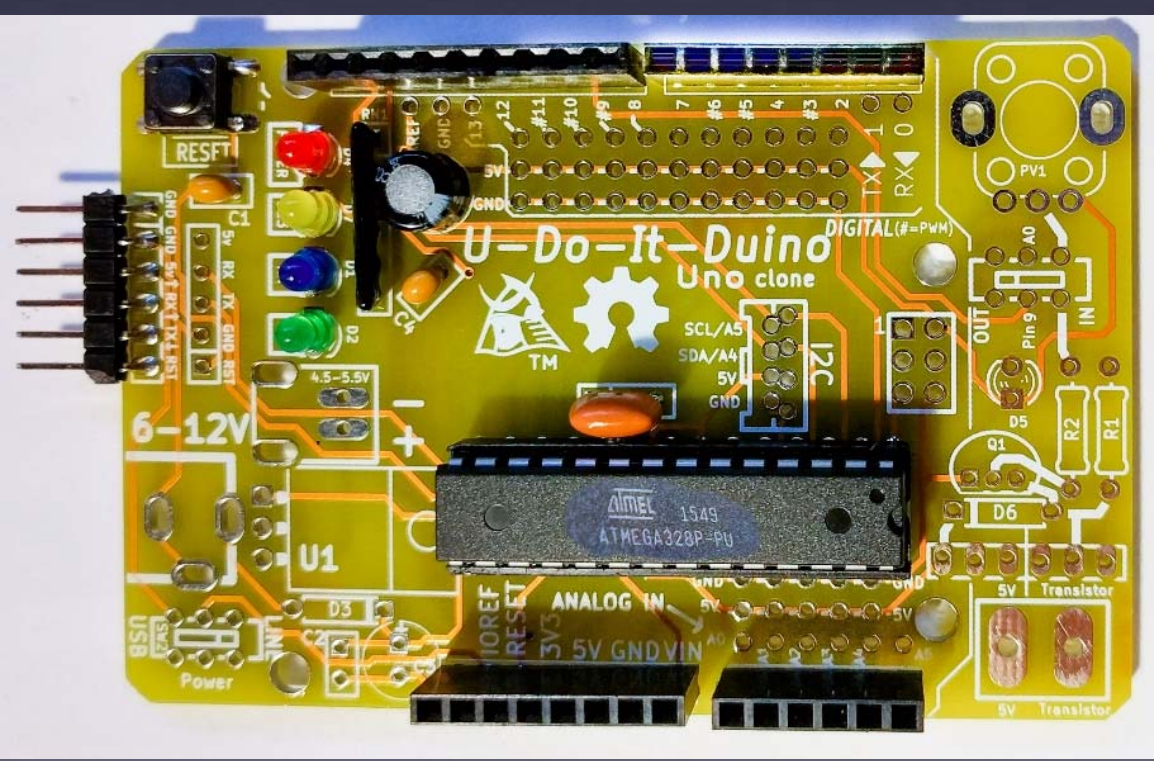
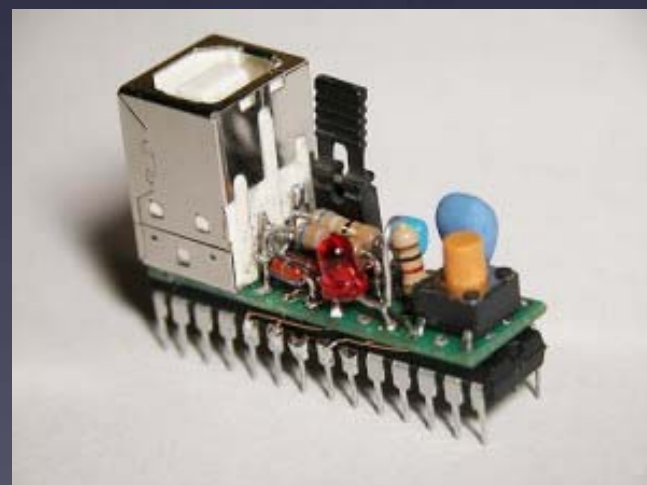
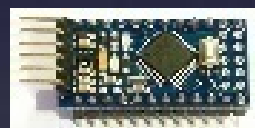
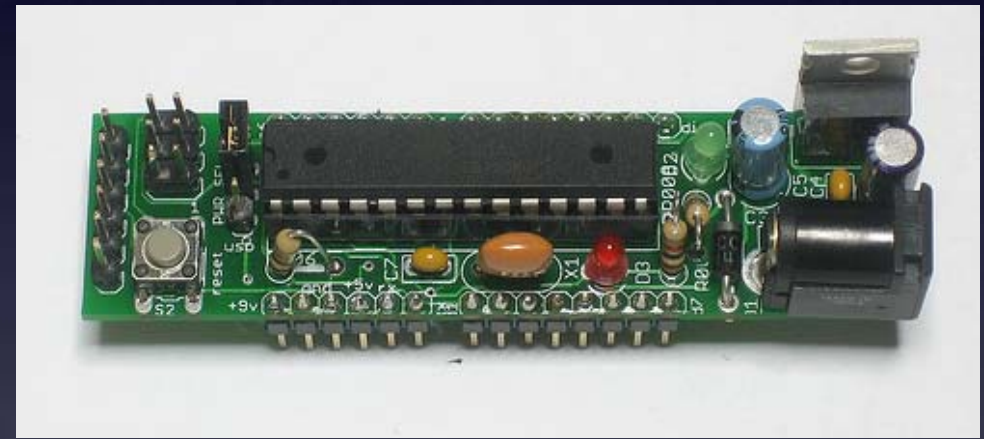
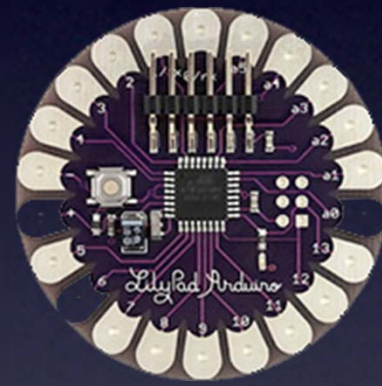
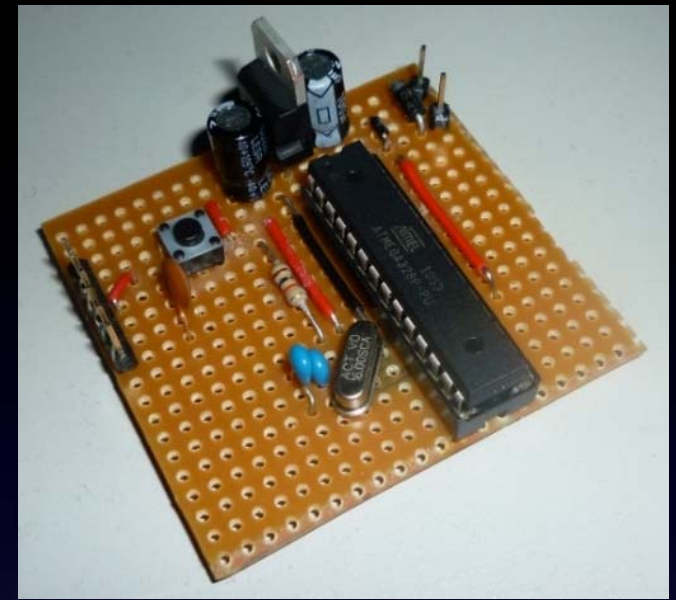
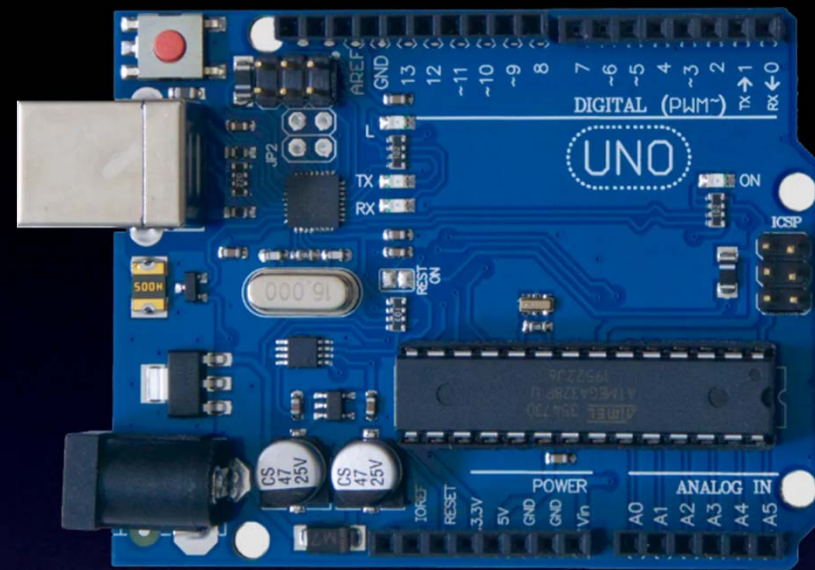
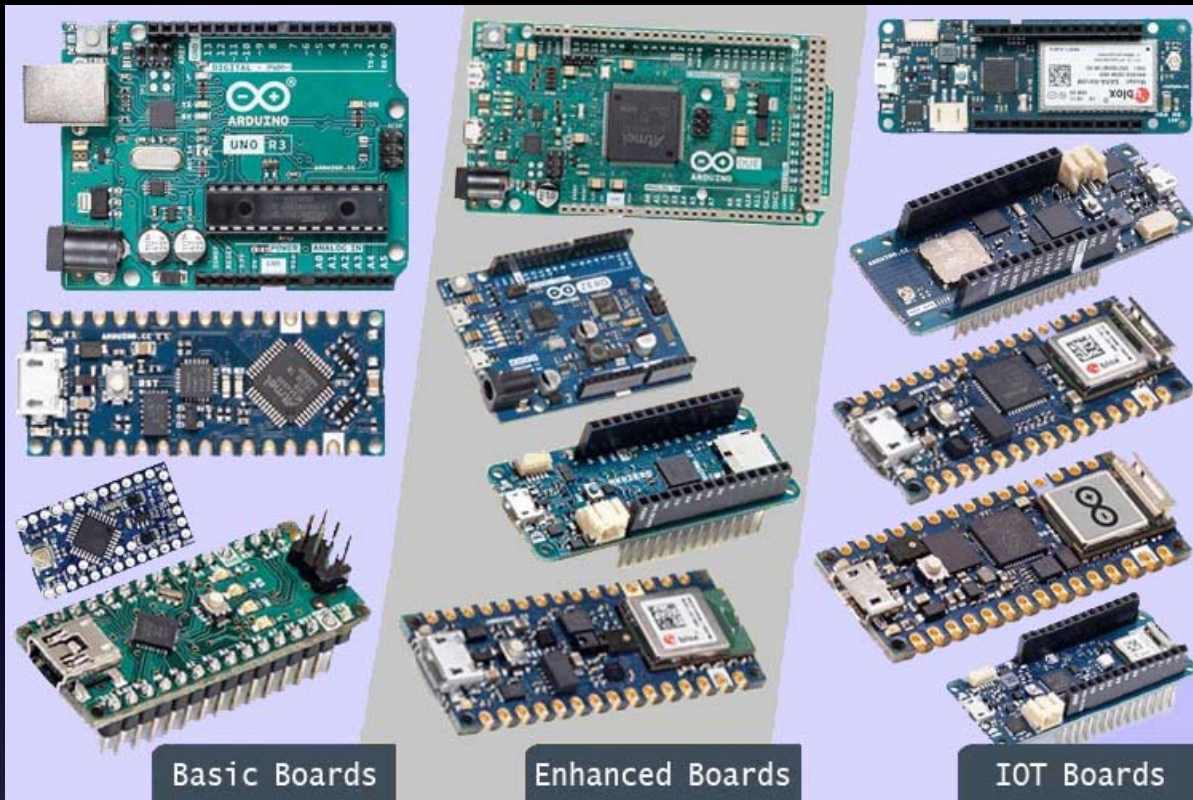

Arduino "Clones"

Intro to Arduino

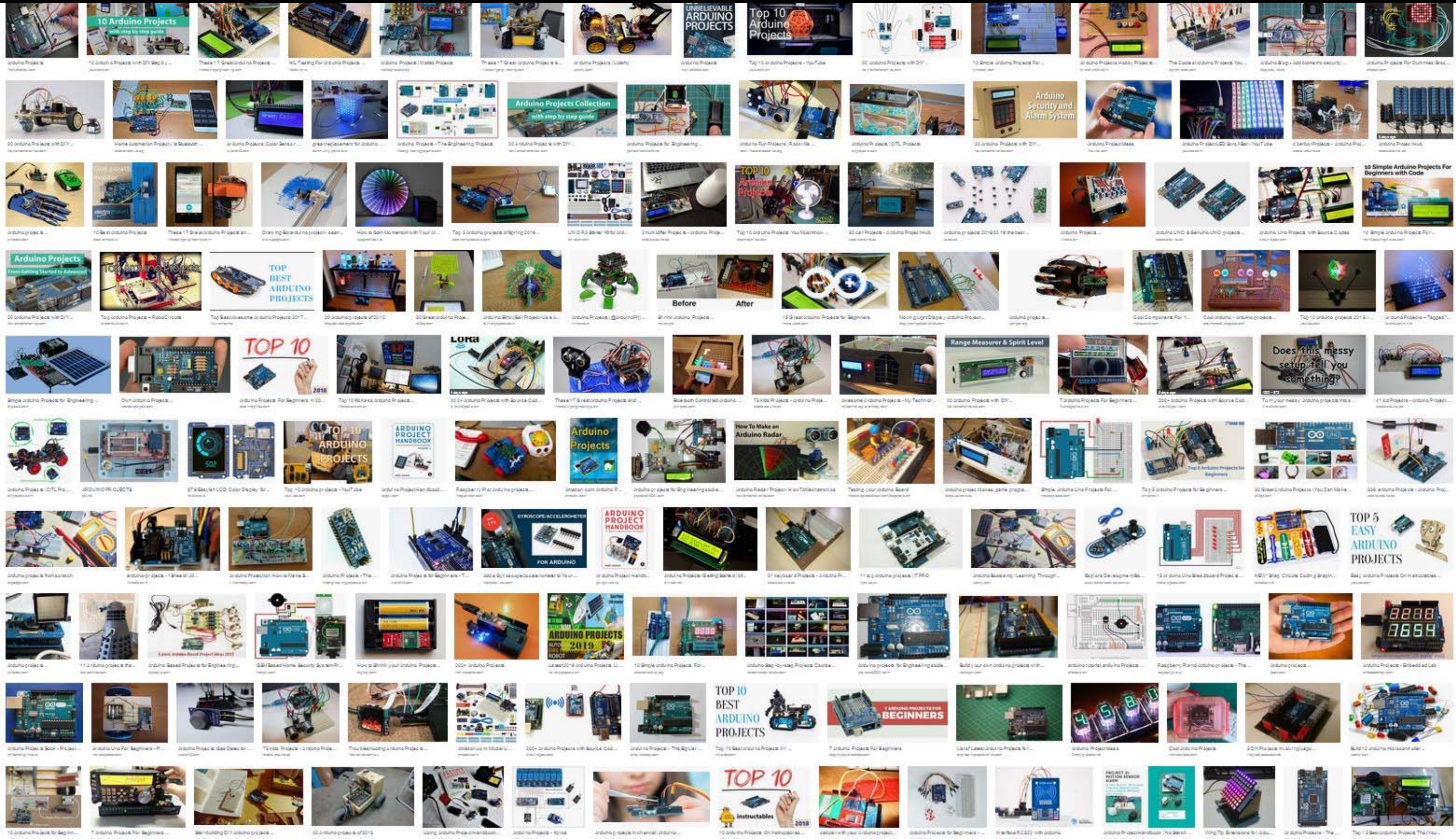

hundreds of thousands of projects online!

Intro to Arduino

“Arduino-Compatible”

*ArduTouch
music
synthesizer
kit*

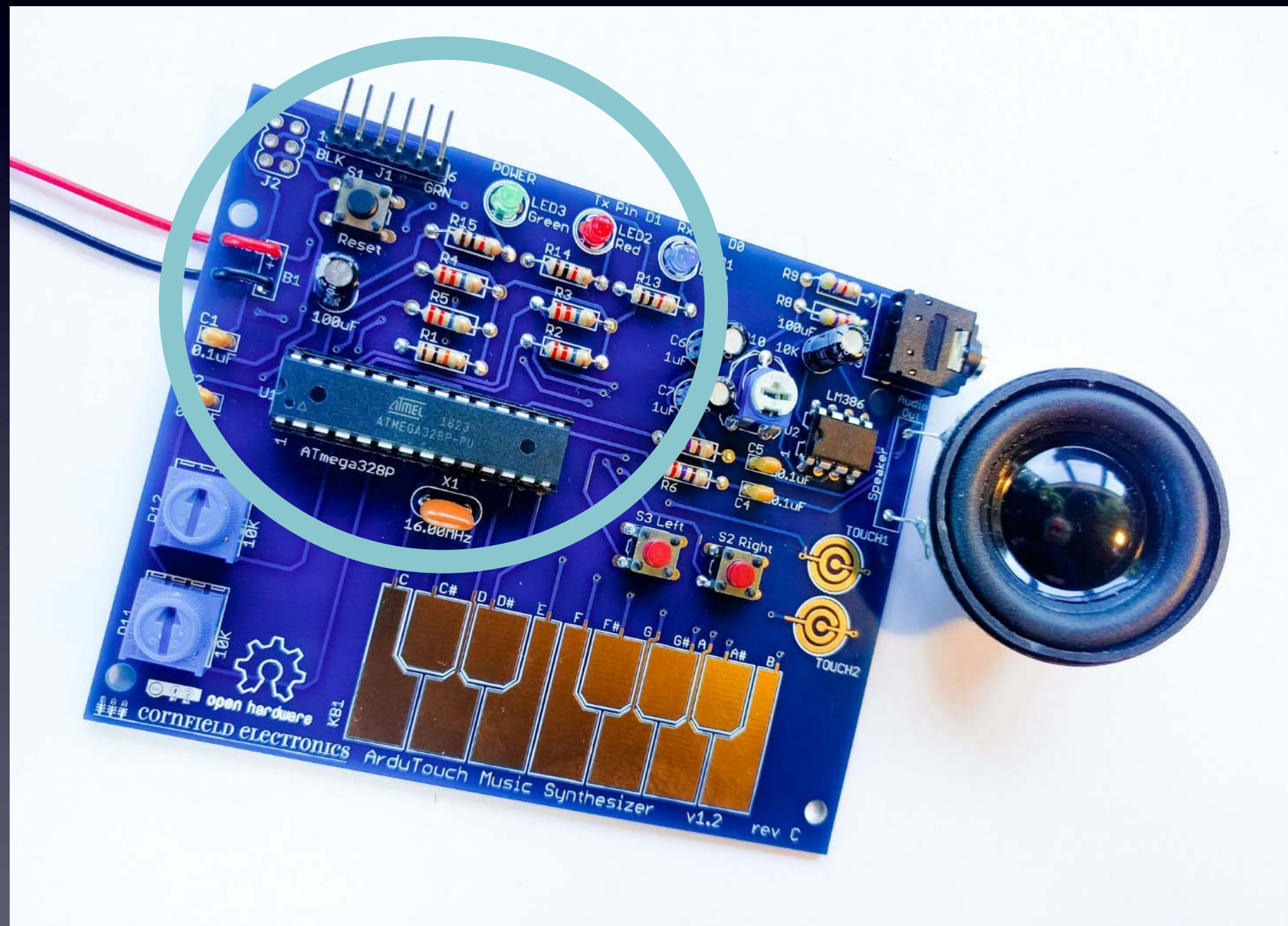

Intro



Intro

Questions?

Everything You Need to Know About Electronics

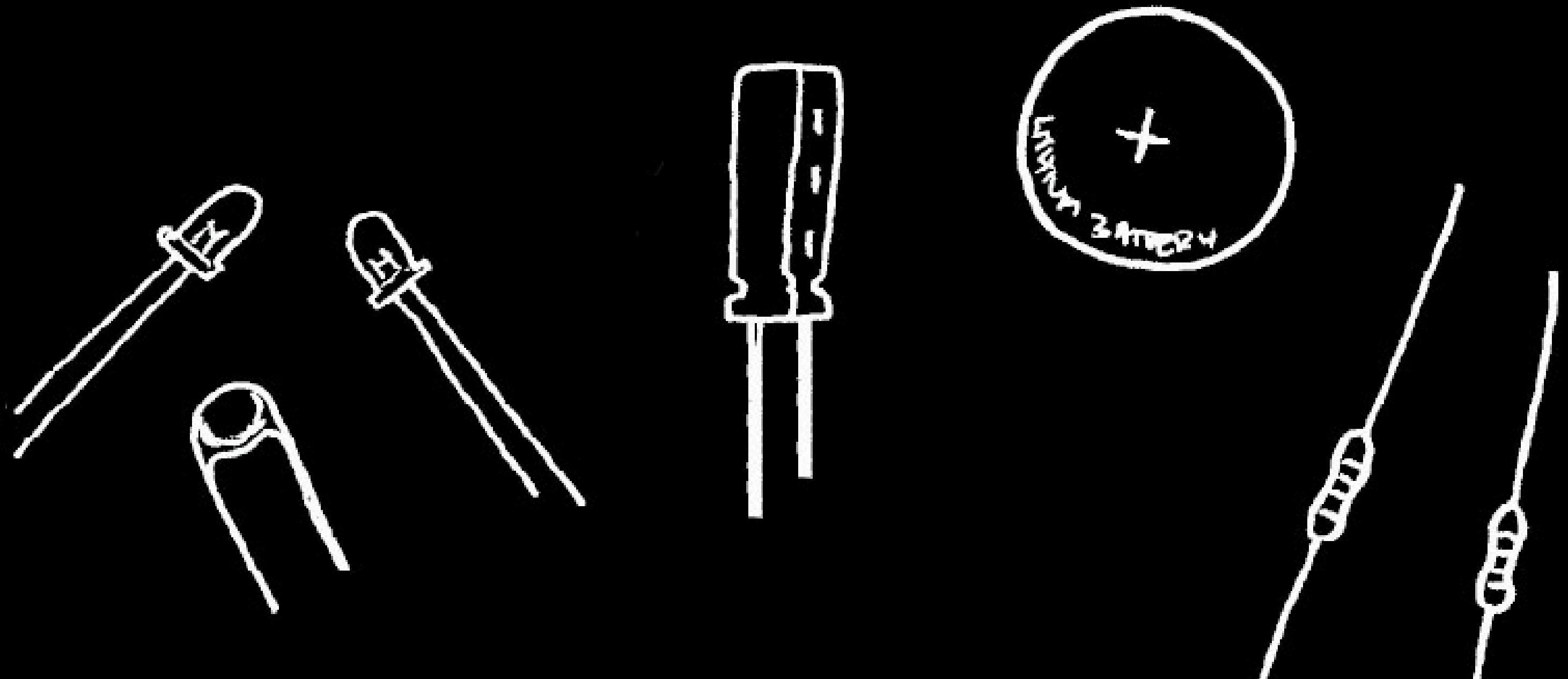

Everything You Need to Know About Electronics

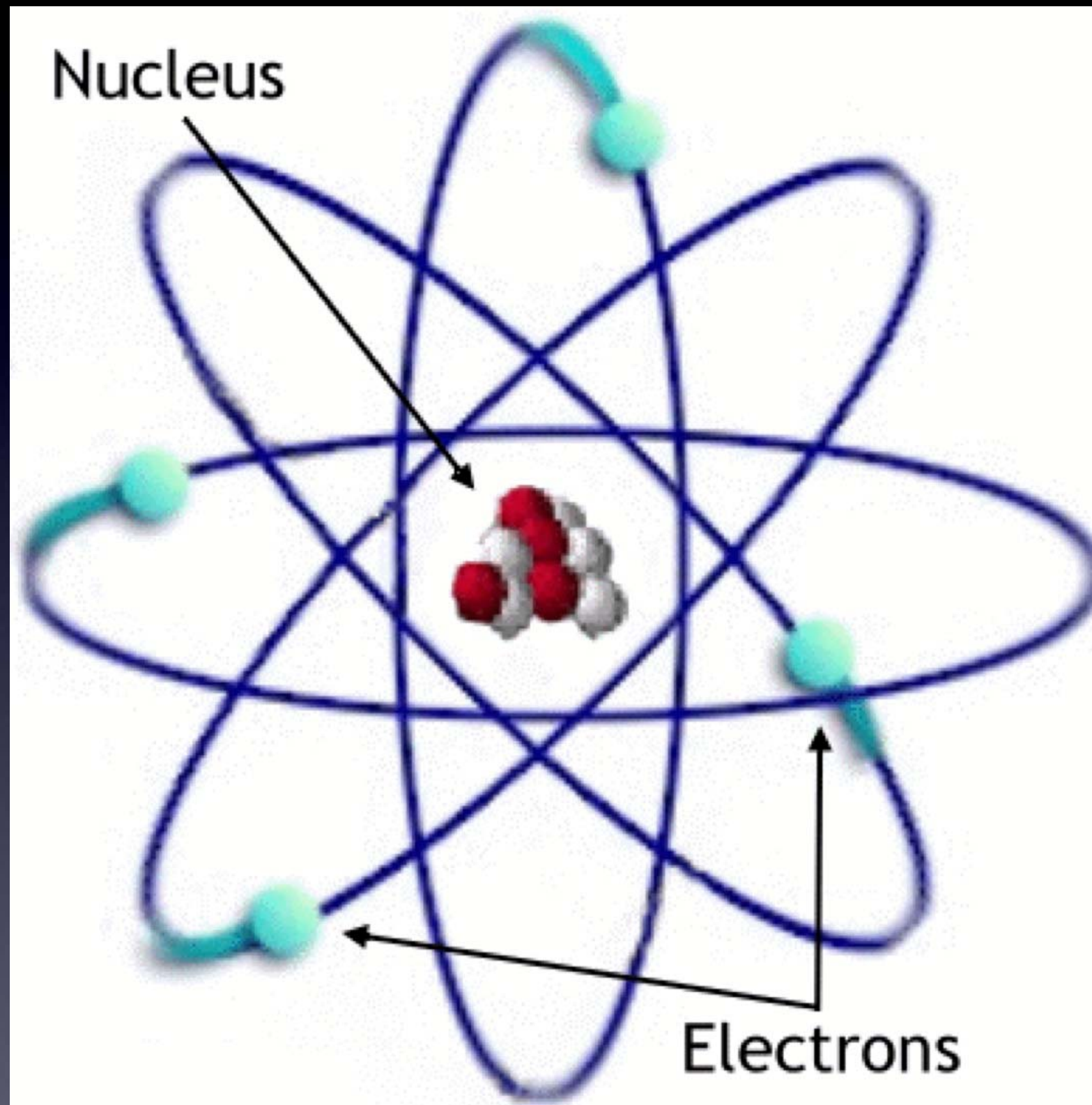

Electrons

Everything You Need to Know About Electronics

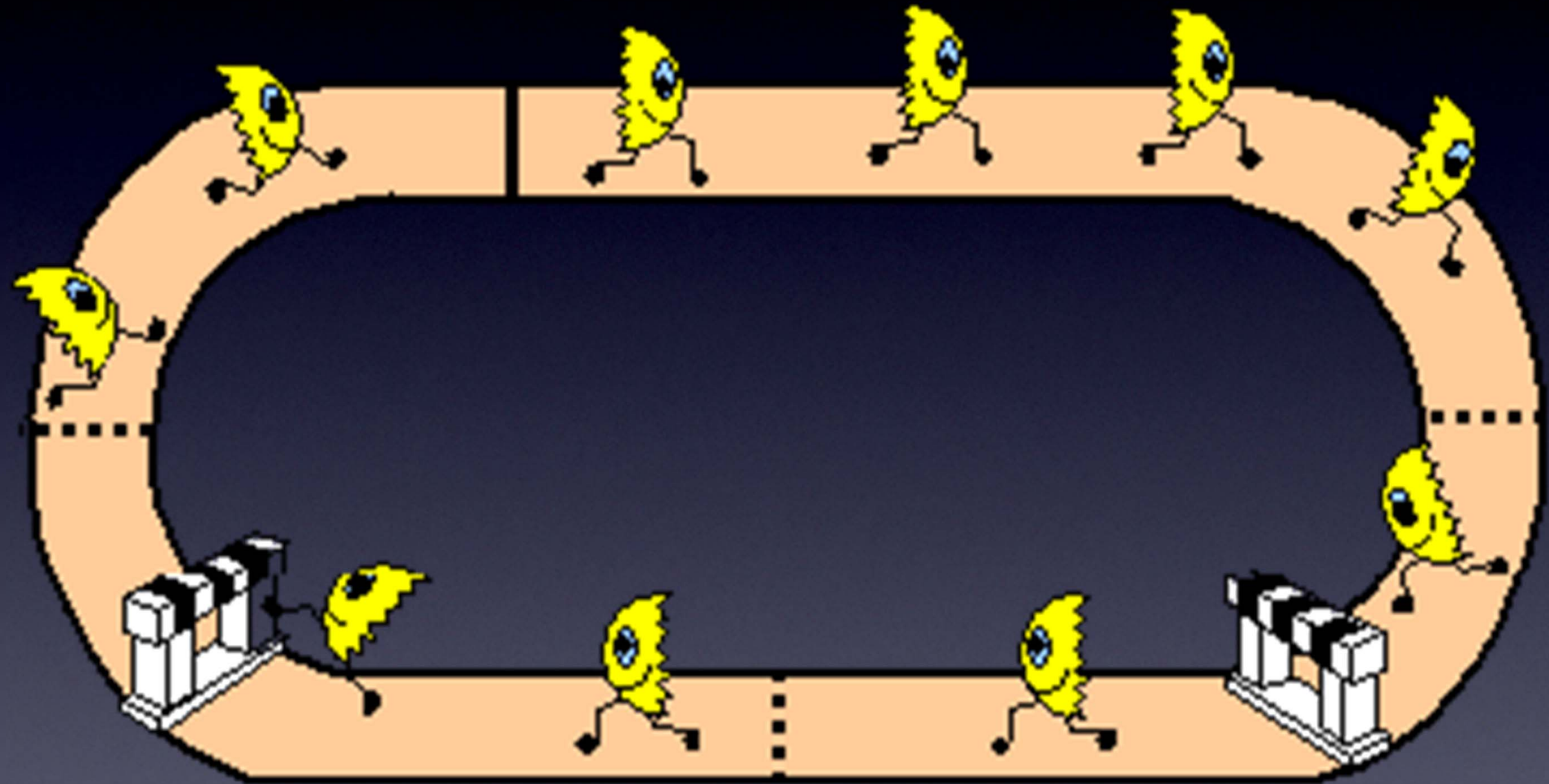

Circuit = Electrons going in complete circle = Magic!

Everything You Need to Know About Electronics

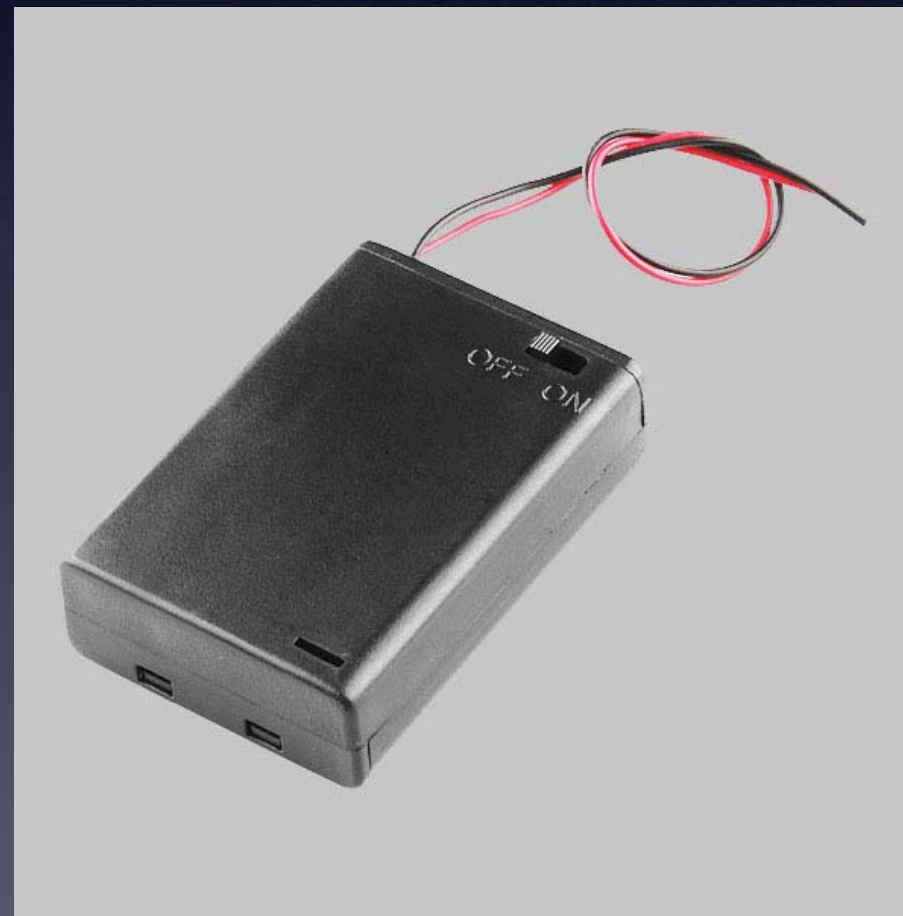
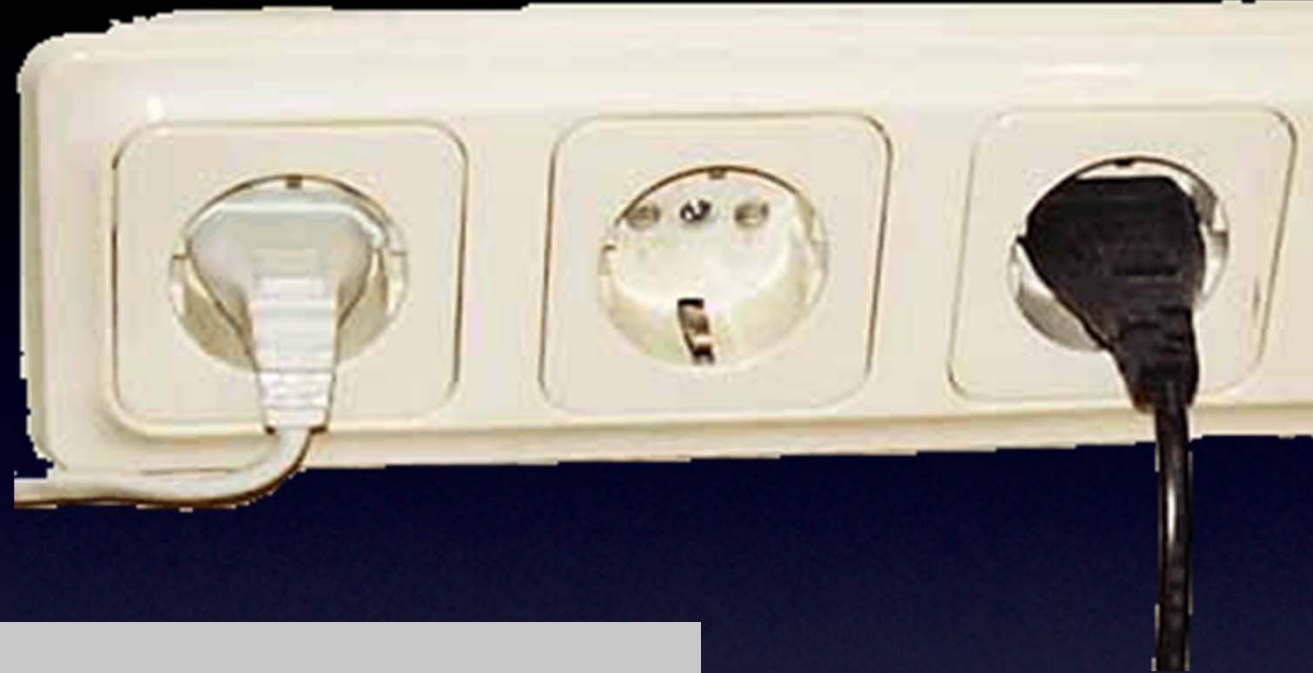

Power Supplies

Everything You Need to Know About Electronics



Voltage / **Volts**

Everything You Need to Know About Electronics

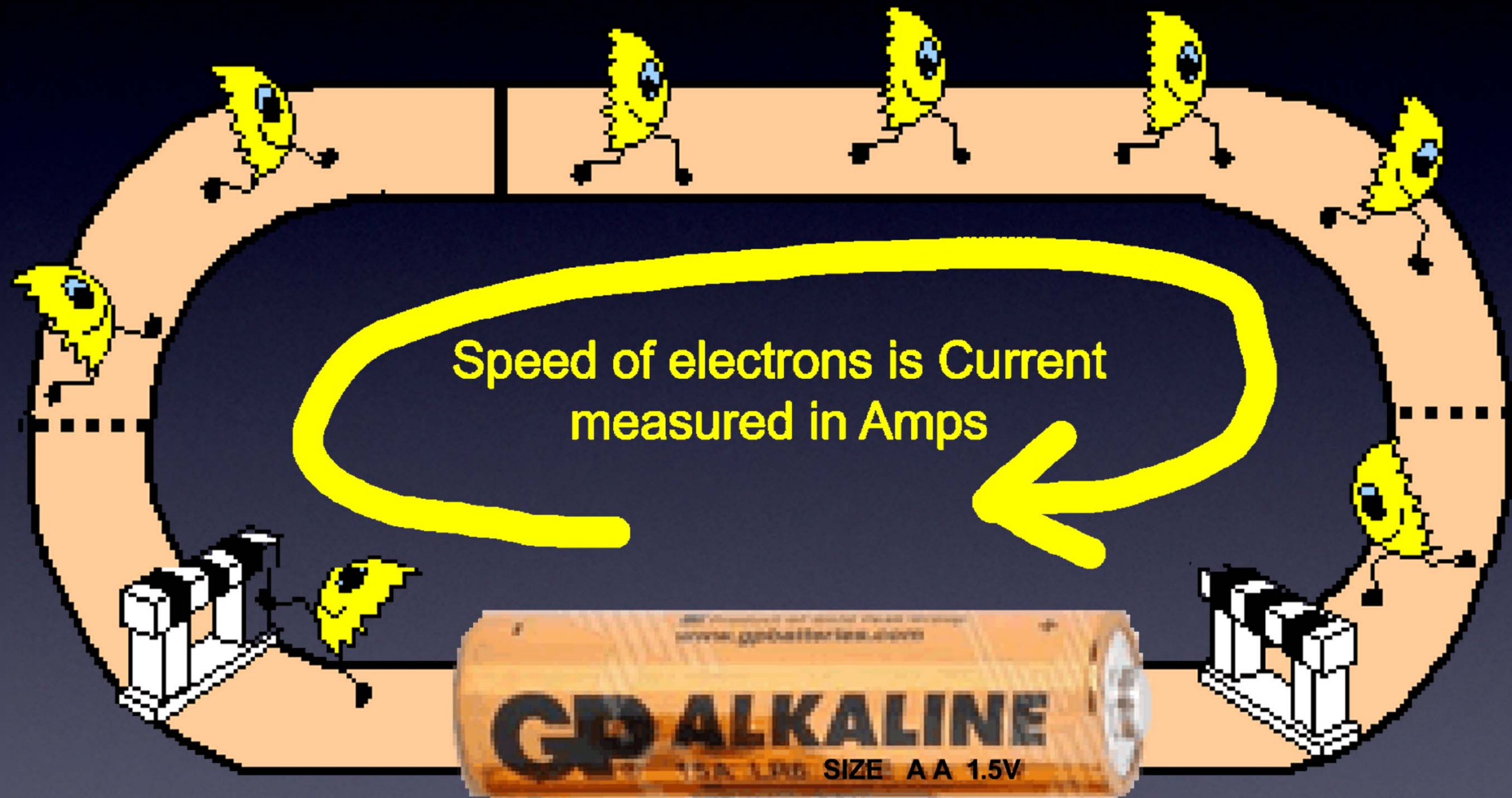

Electrons pushed with 1.5V.
So, they move!

Current / **Amps**

Everything You Need to Know About Electronics

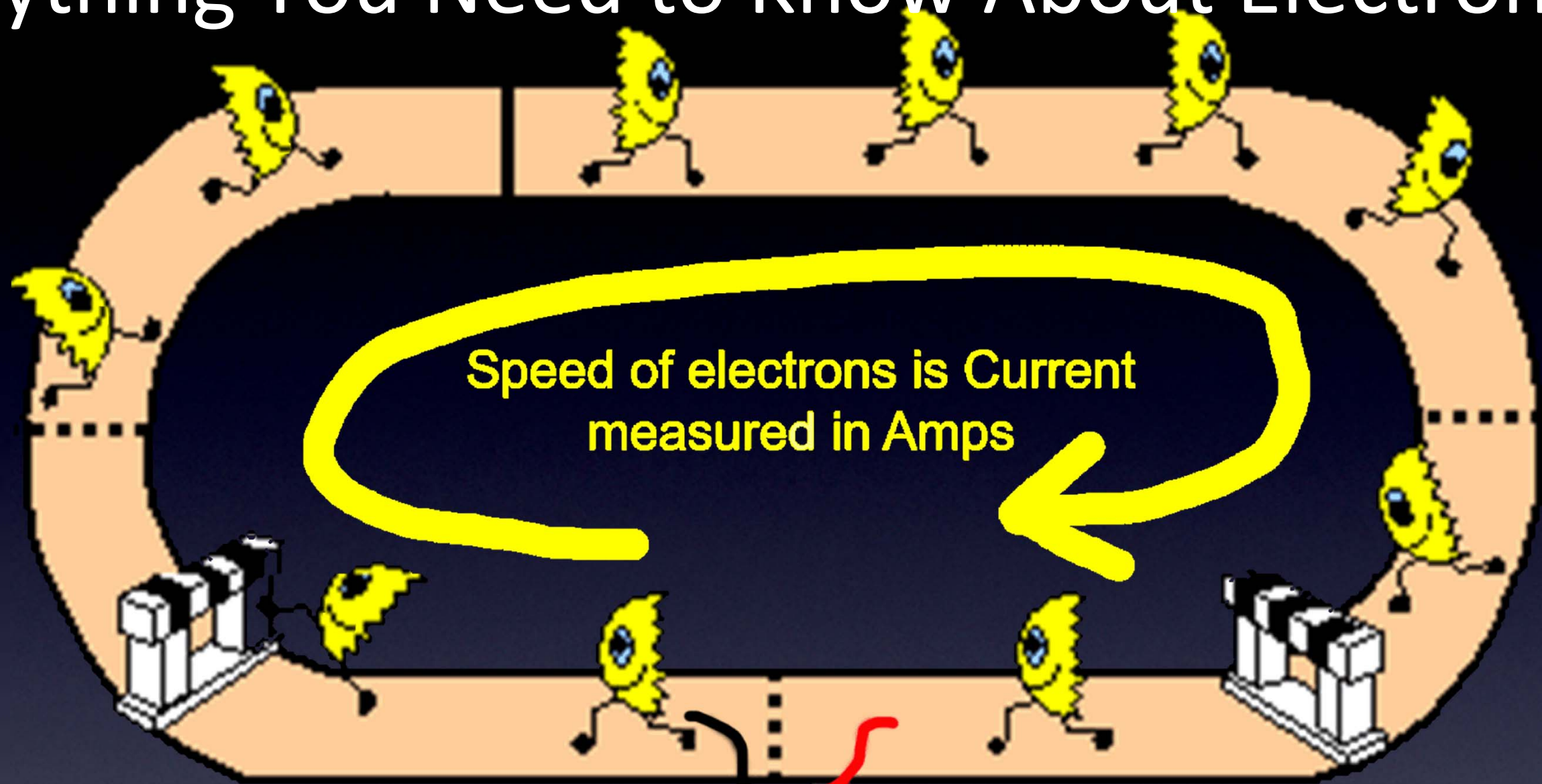

3 times more Volts
3 times more push
3 times faster electrons
3 times more current / Amps

Current / Amps

Everything You Need to Know About Electronics

Too much energy?

Lots of energy!

Current / Amps

Everything You Need to Know About Electronics

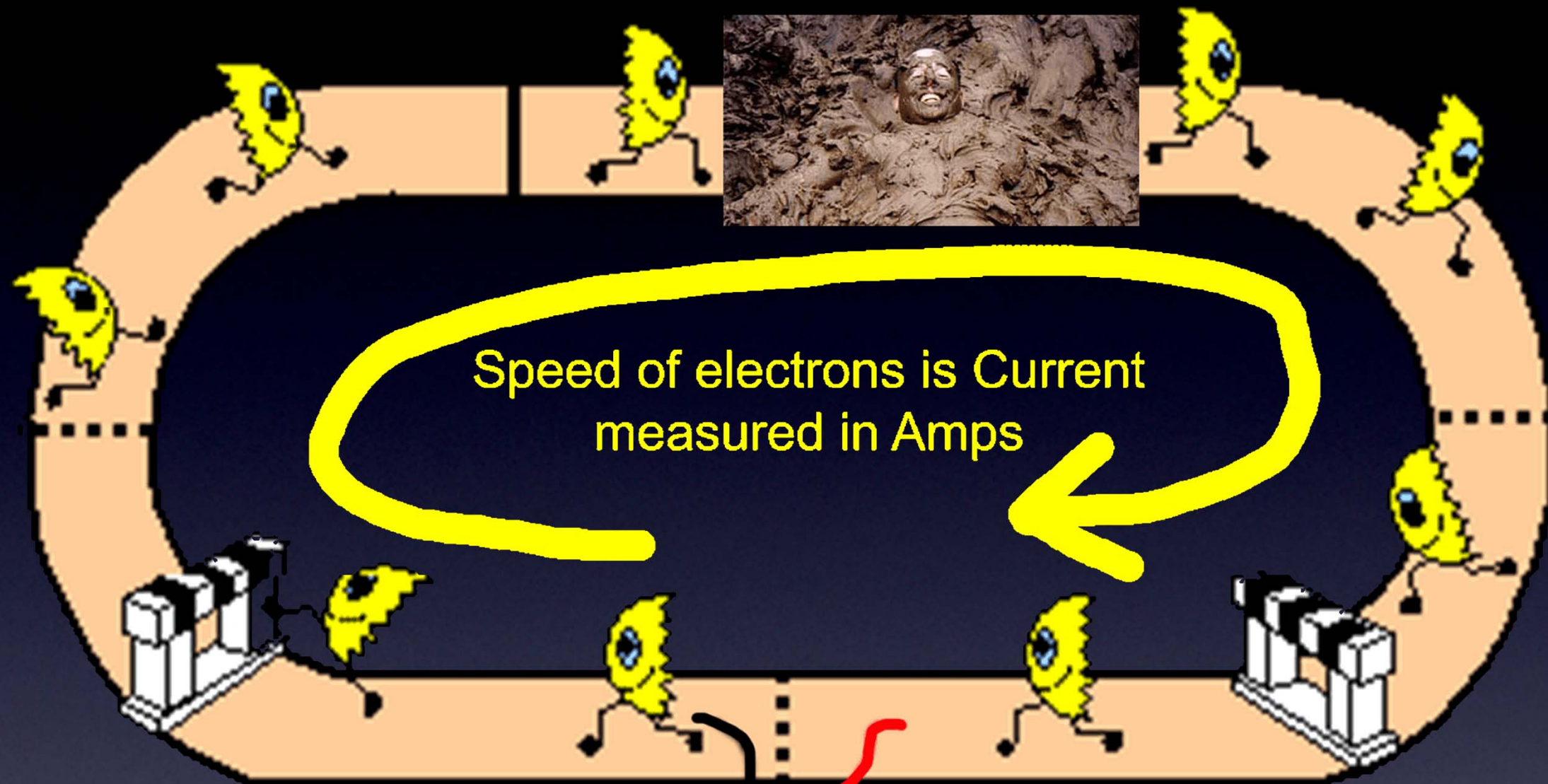

Resistance in the electrons' path slows them down, which means less current (less Amps).



Resistance / **Ohms**

Everything You Need to Know About Electronics

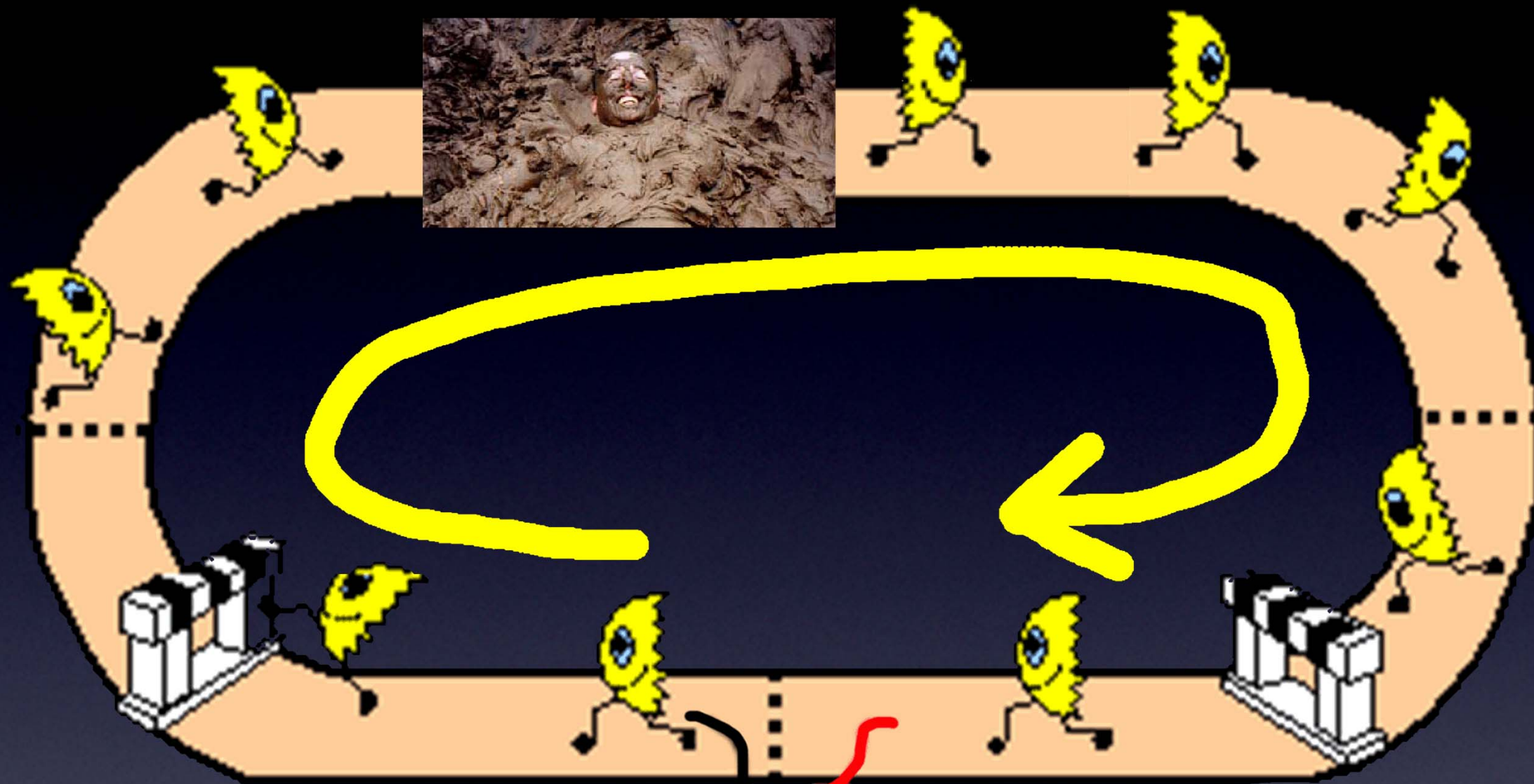

Same
Circuit!

Resistance / Ohms

Everything You Need to Know About Electronics

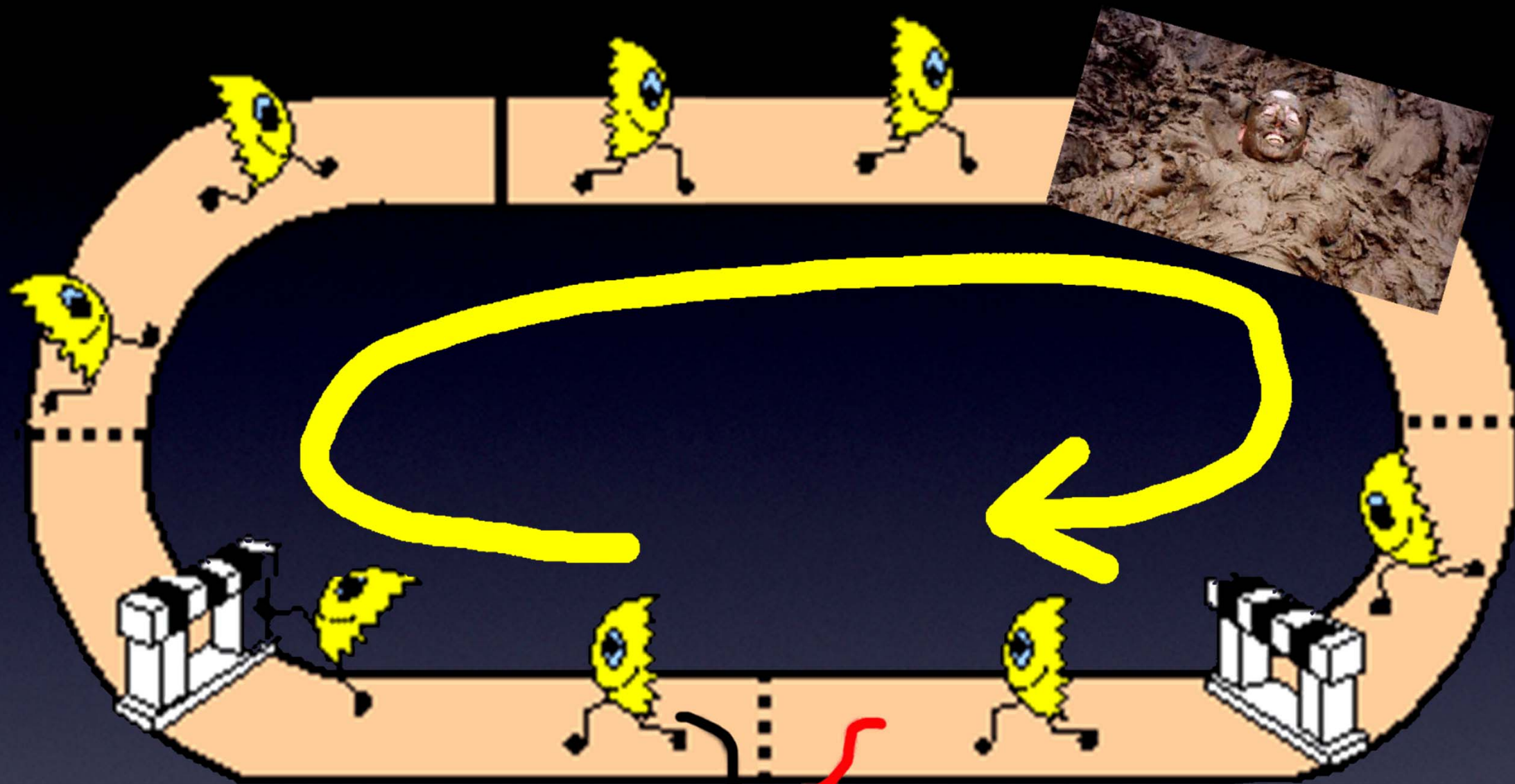

Resistance / Ohms

Same
Circuit!

Everything You Need to Know About Electronics

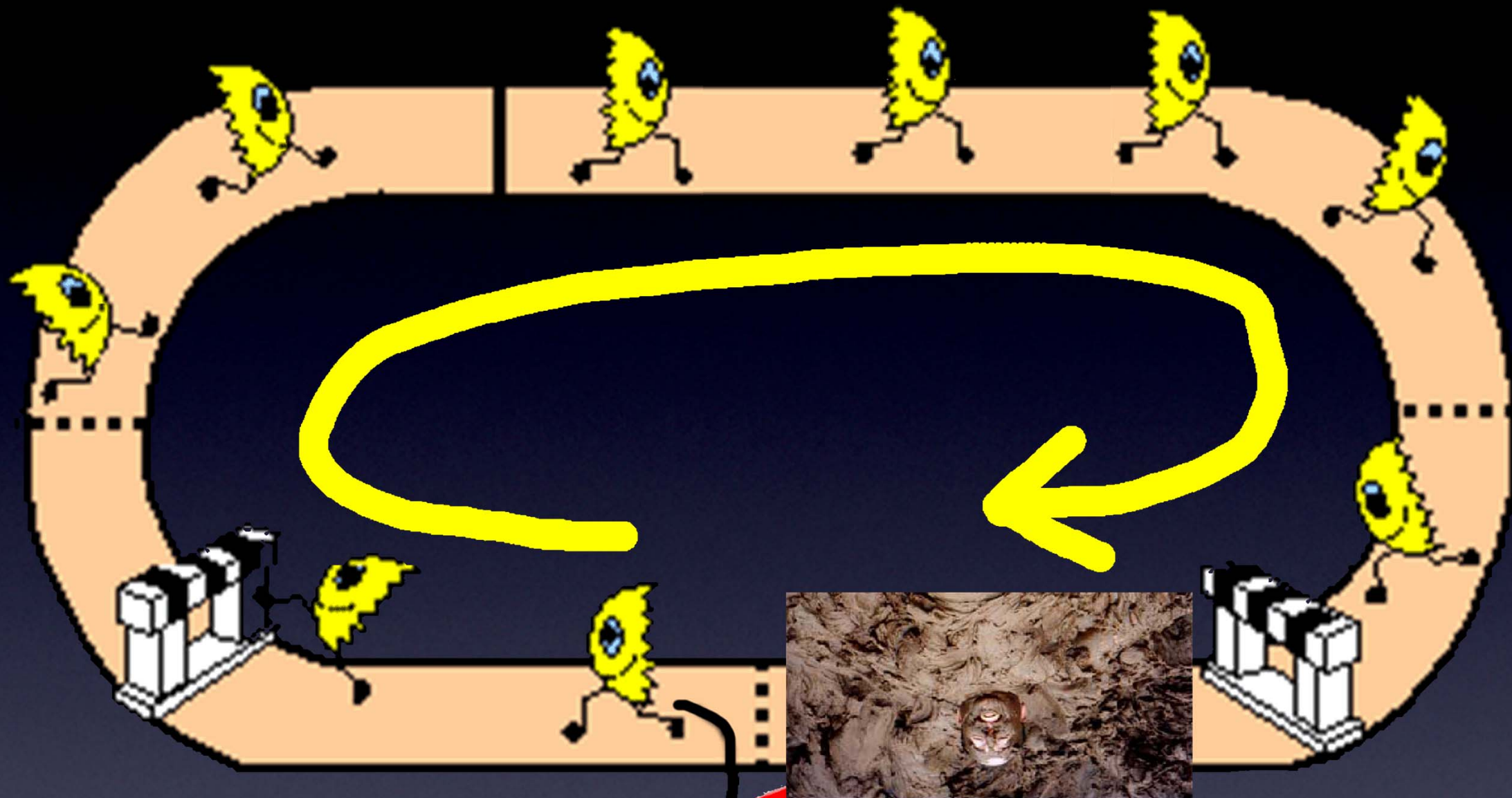

Resistance / Ohms

Same
Circuit!

Everything You Need to Know About Electronics

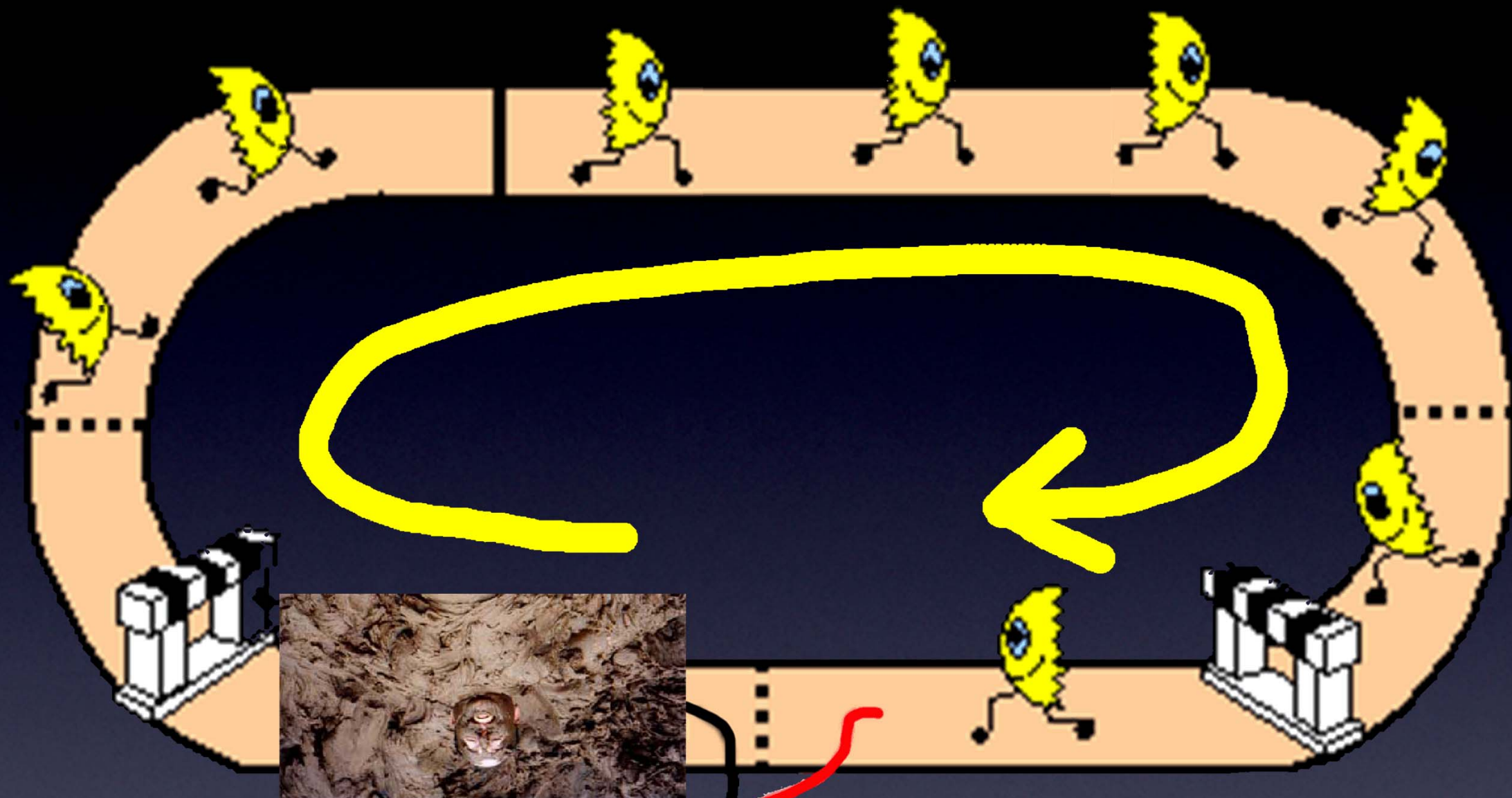

Same
Circuit!

Resistance / Ohms

Everything You Need to Know About Electronics

Ohm's Law

Volts -- *force* pushing electrons

Amps -- *speed* of electrons

Ohms -- *Resistance* to flow of electrons

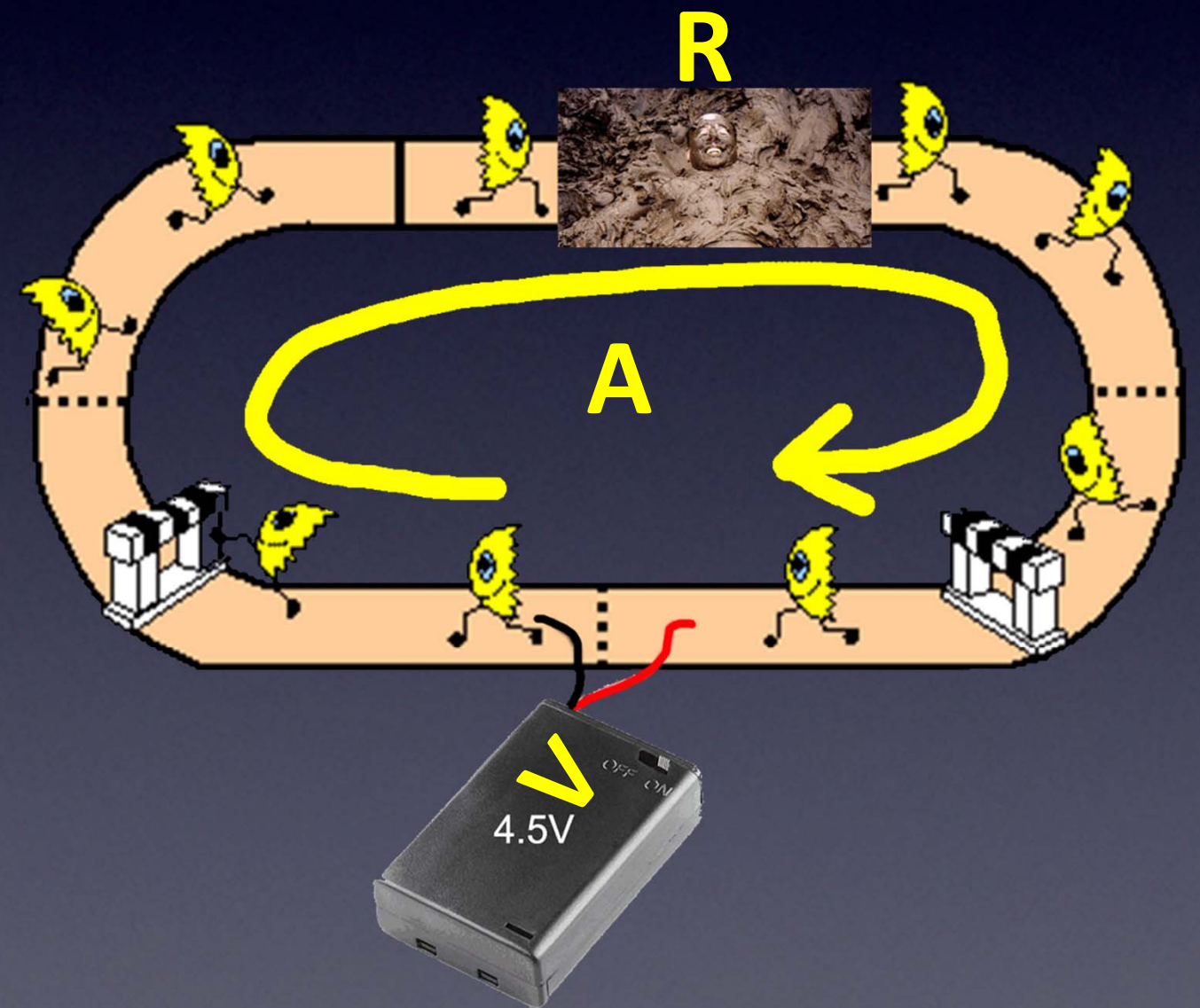

Everything You Need to Know About Electronics

Ohm's Law

Volts -- *force* pushing electrons

Amps -- *speed* of electrons

Ohms -- *Resistance* to flow of electrons

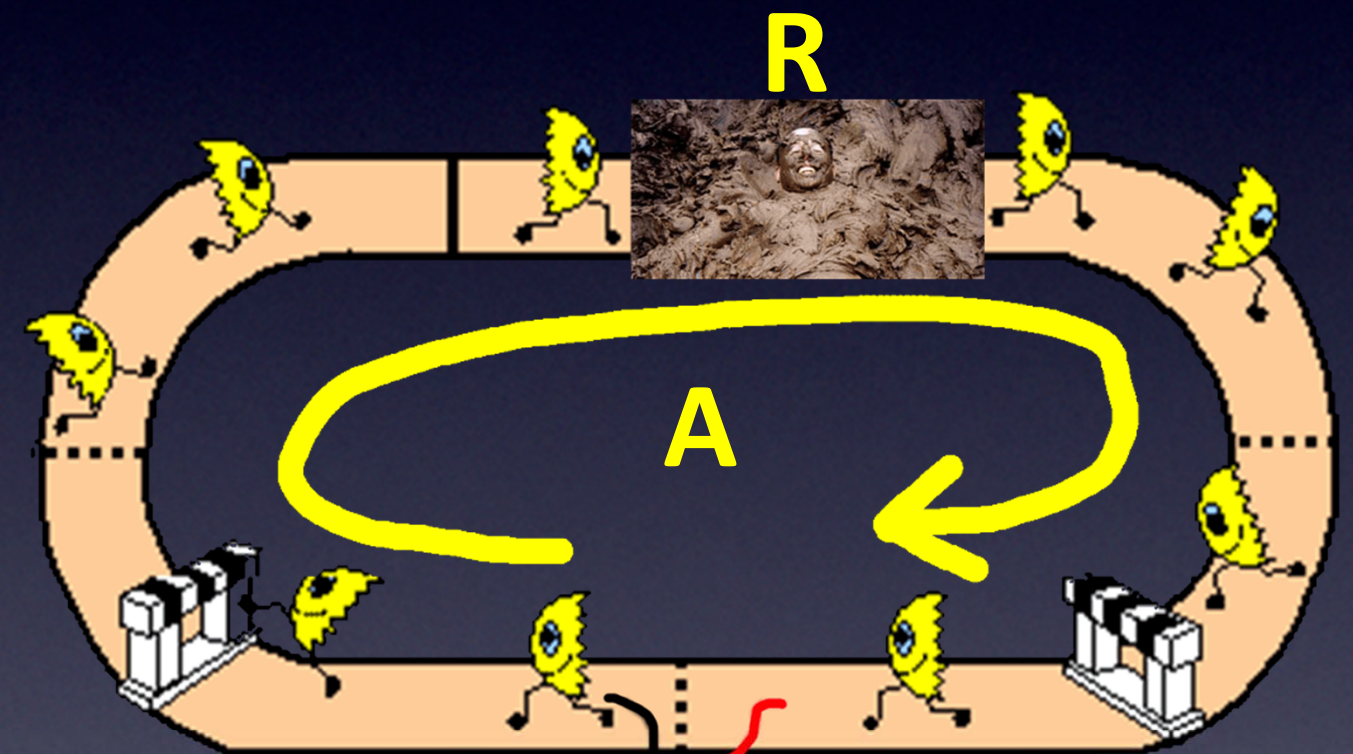

$$\text{Volts} = \text{Amps} \times \text{R}$$

(Ohms)

Everything You Need to Know About Electronics

Ohm's Law

Volts -- *force* pushing electrons

Amps -- *speed* of electrons

Ohms -- *Resistance* to flow of electrons

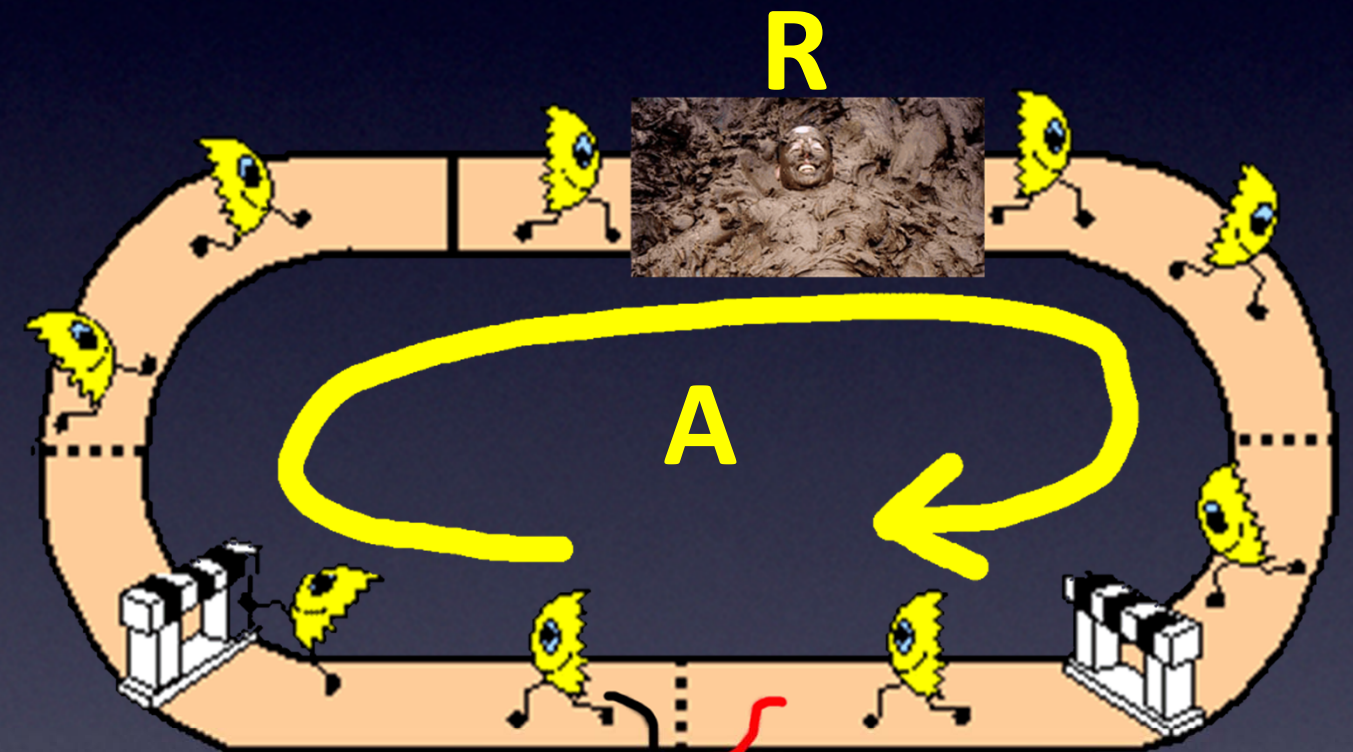

$$\text{Volts} = \text{Amps} \times R$$

Also commonly written: $E = I \times R$

(Ohms)

Everything You Need to Know About Electronics

The symbol for
Resistance:

Ω

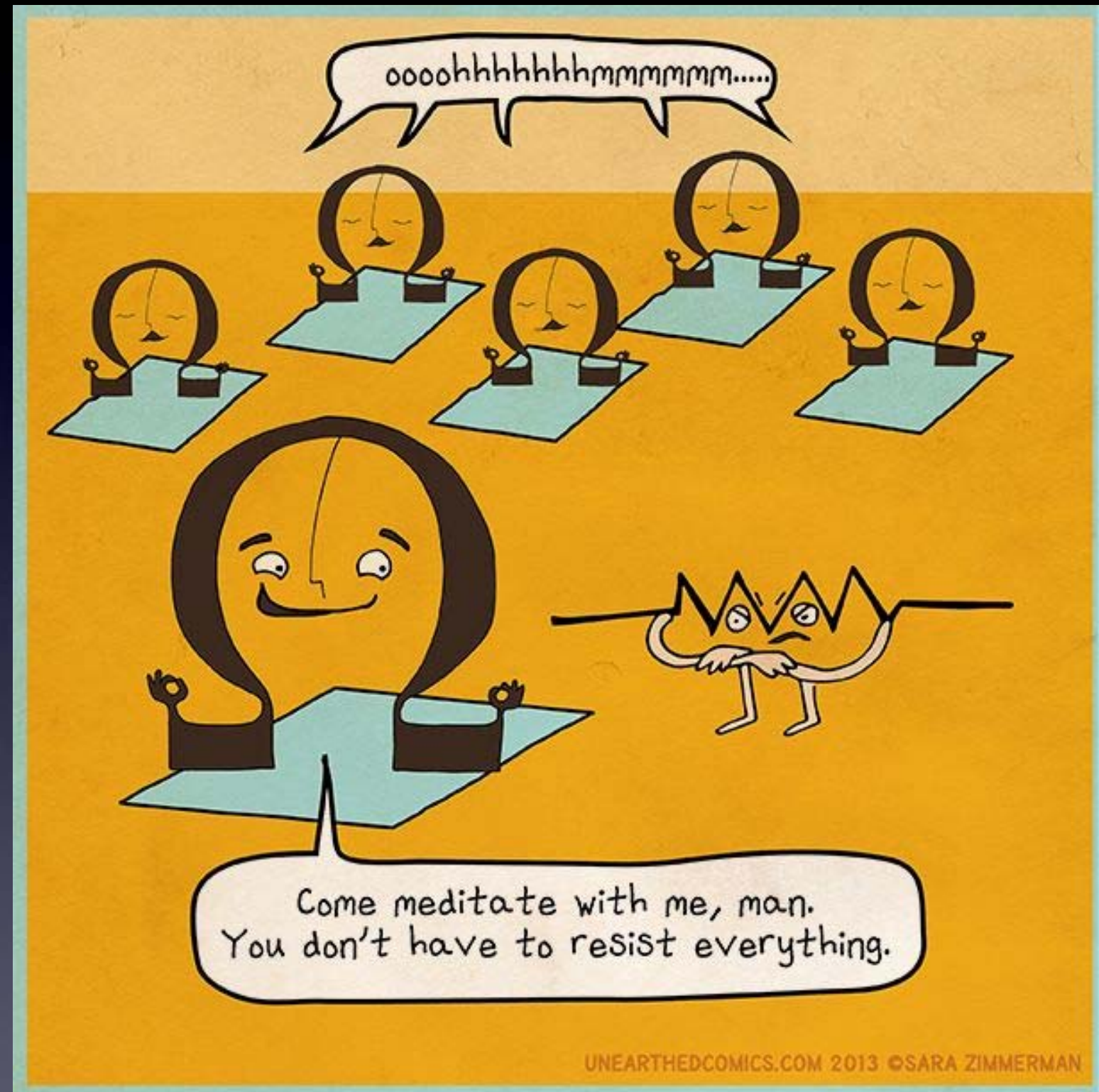

Resistor / Ohms

Everything You Need to Know About Electronics

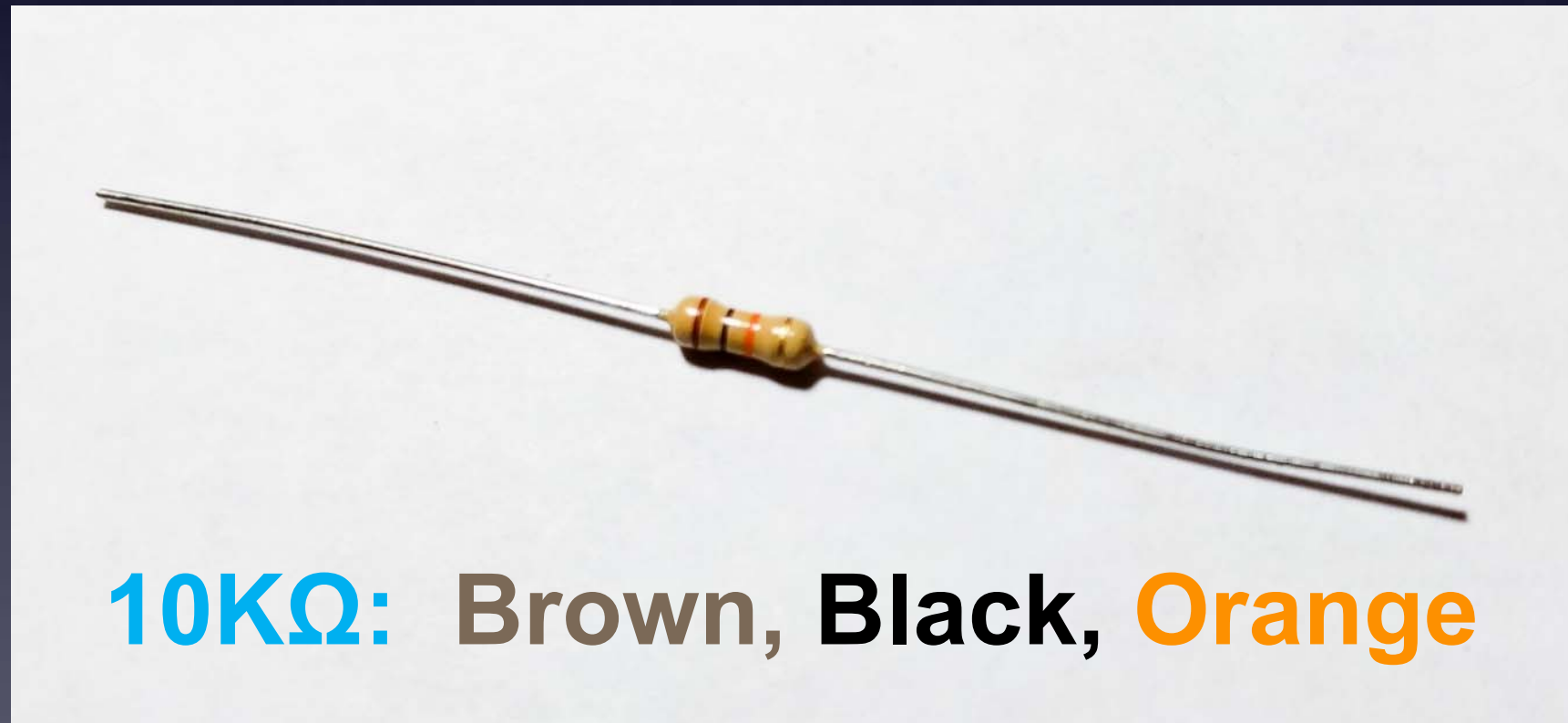
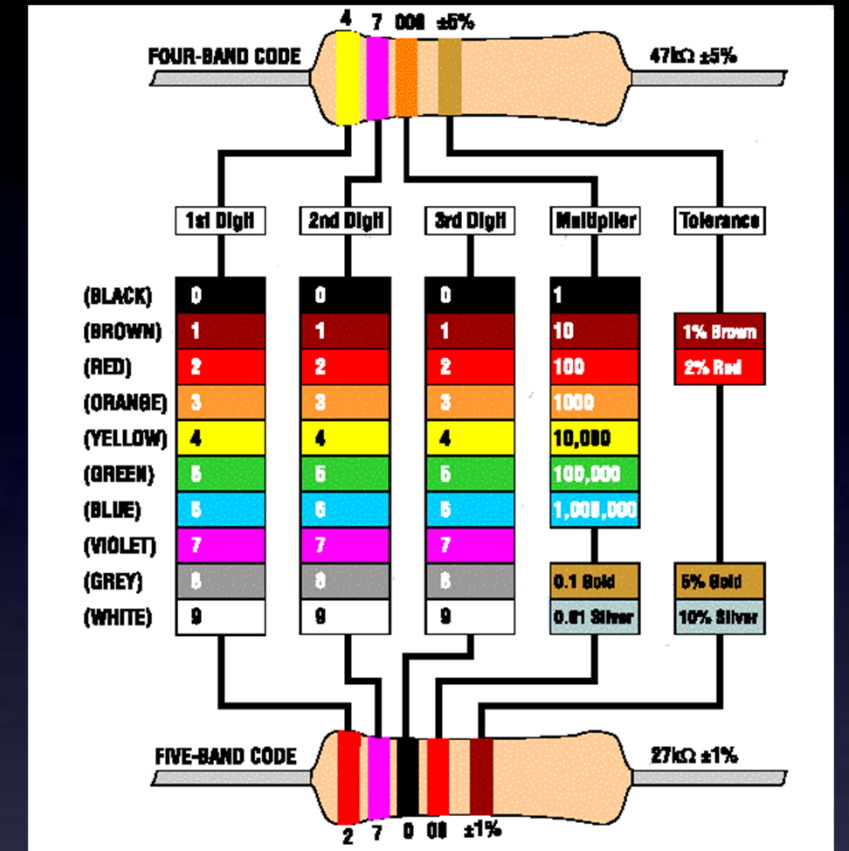
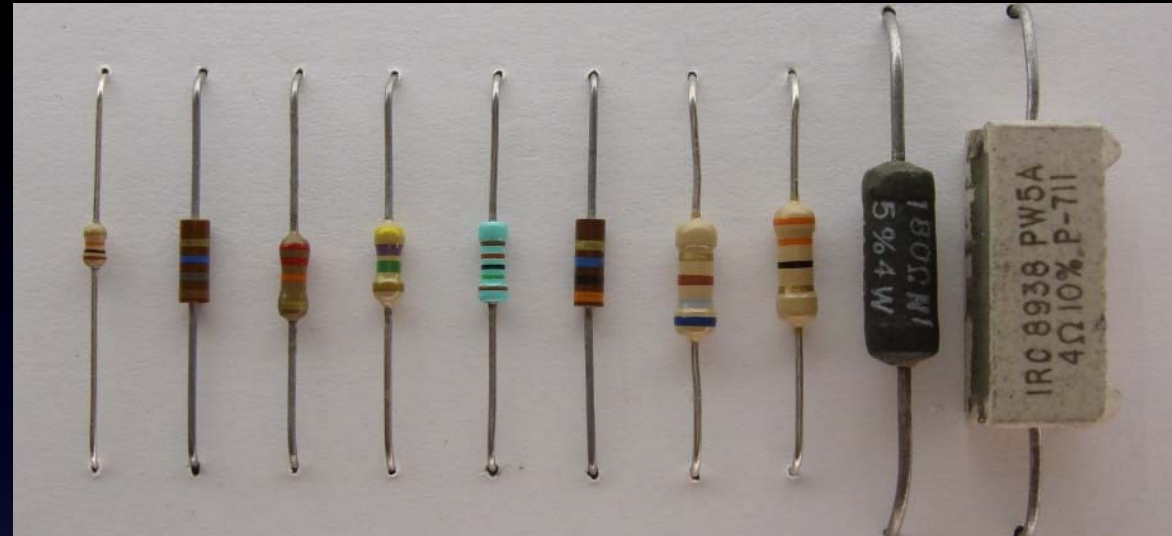

10KΩ: Brown, Black, Orange

Resistor / Ohms

Everything You Need to Know About Electronics

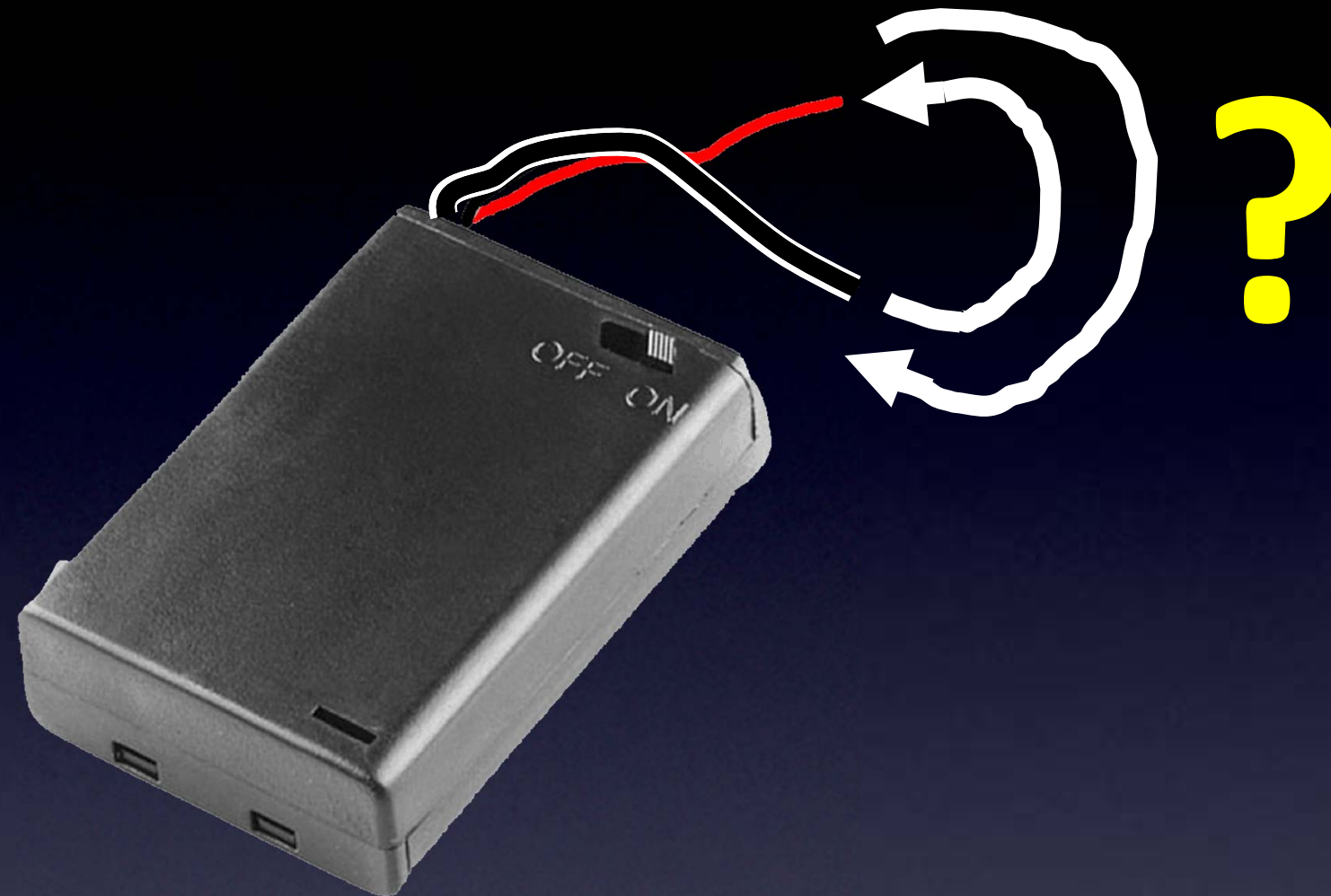

What happens?

polarity

Power Supply – it matters how you connect it!

Everything You Need to Know About Electronics

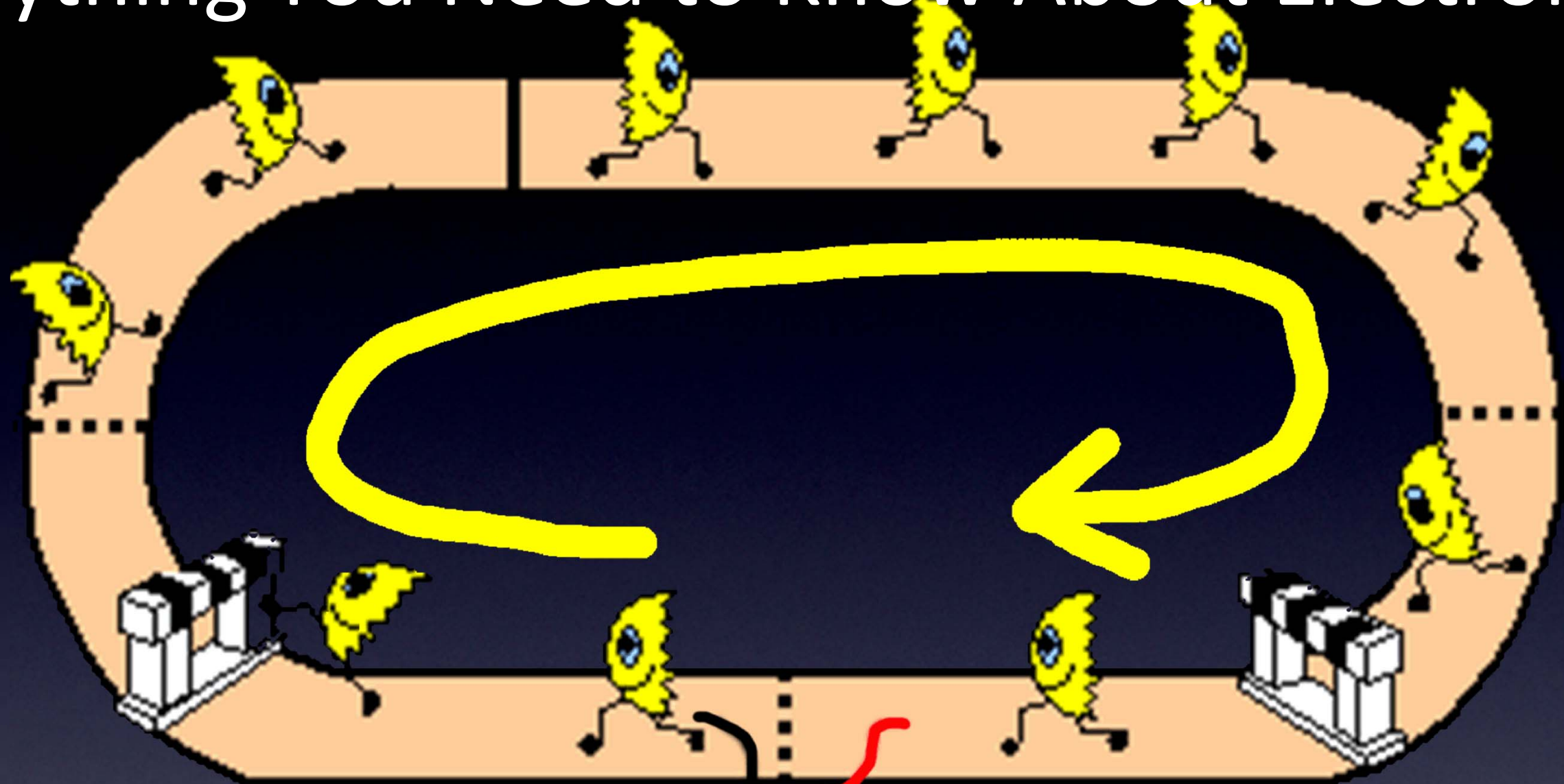

Black Wire = “-”

Red Wire = “+”



Power Supply – it matters how you connect it!

Everything You Need to Know About Electronics



Red wire:
Power,
Plus, Positive,
4.5V,
Vcc

Black wire:
Minus, Negative,
0V,
Ground (GND)

Power Supply – it matters how you connect it!

Everything You Need to Know About Electronics

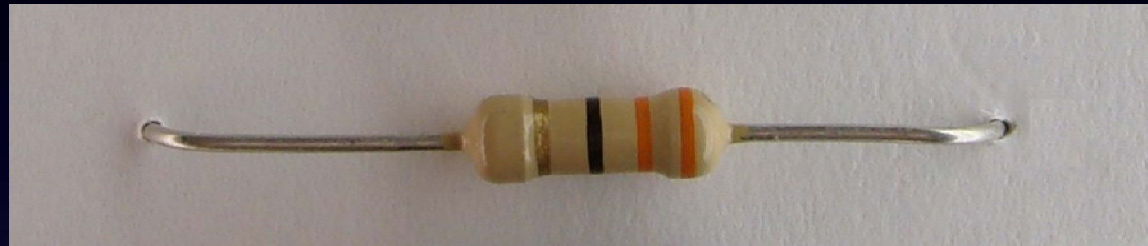

or



or



(electrons slowed down the same either way)

Resistors – it doesn't matter which way

Everything You Need to Know About Electronics

Minus / Negative side

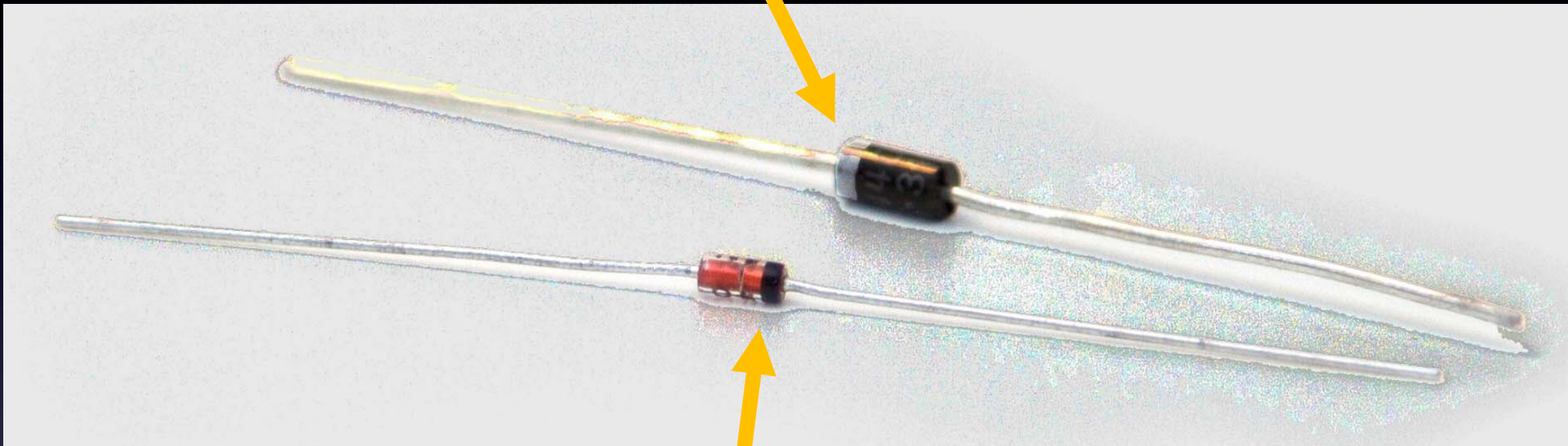

Minus / Negative side

Diodes – One-Way valve for electrons

Diodes – it matters which way!

Everything You Need to Know About Electronics



Short wire is Minus / Negative

Special kind of Diode – it Emits Light!

LED – it matters which way!

Everything You Need to Know About Electronics



Lots of different colored LEDs! (including IR)

LED

Everything You Need to Know About Electronics

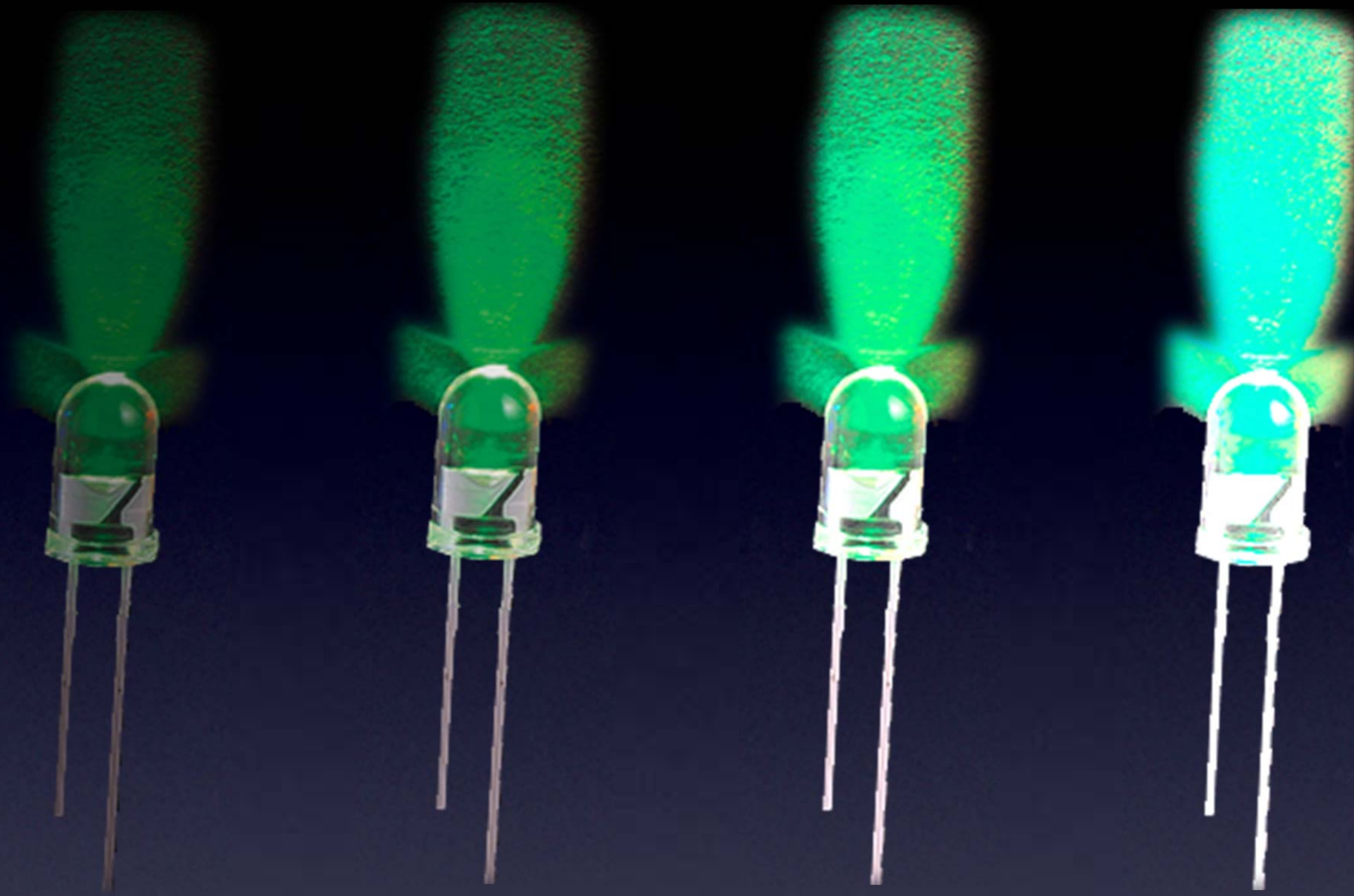

More current \rightarrow More brightness! (until...)

LED

Everything You Need to Know About Electronics



More current → More brightness! (until...)

LED

Everything You Need to Know About Electronics

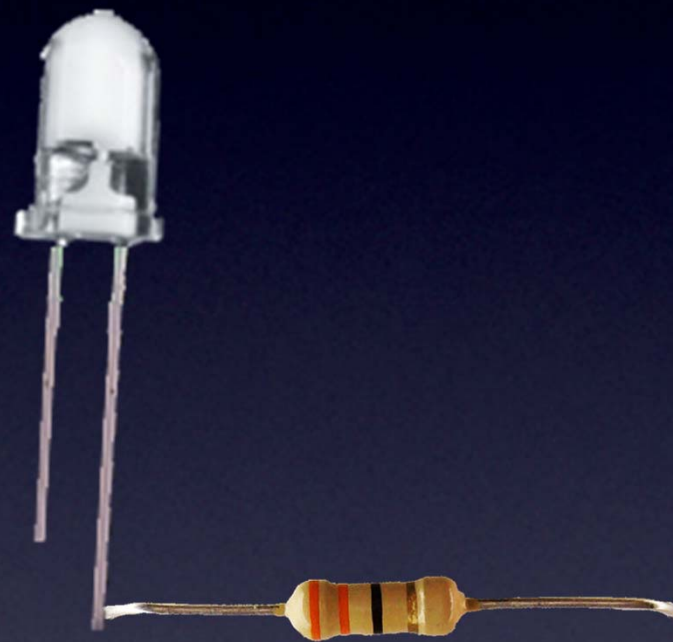

*(with a resistor
so no magic smoke goes away)*

This is why we put a resistor in line with an LED

LED

Everything You Need to Know About Electronics

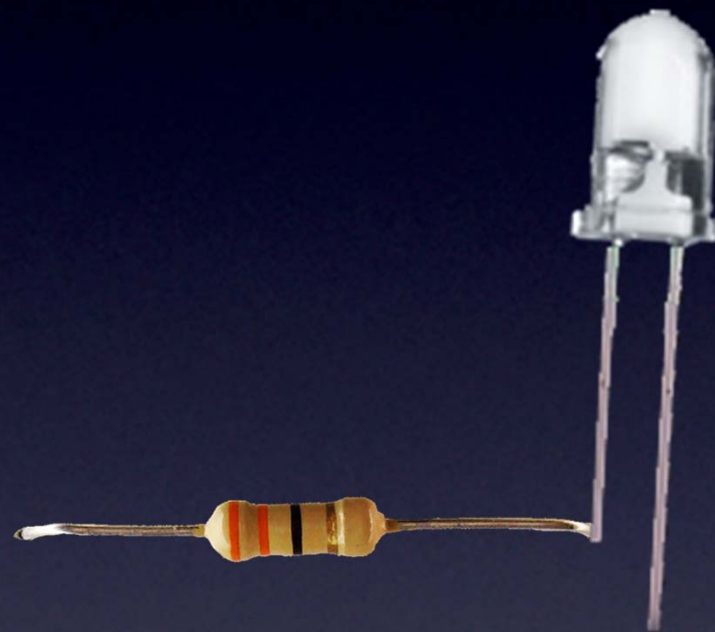

(the resistor can go on either side)

This is why we put a resistor in line with an LED

LED

Everything You Need to Know About Electronics



Series = in line

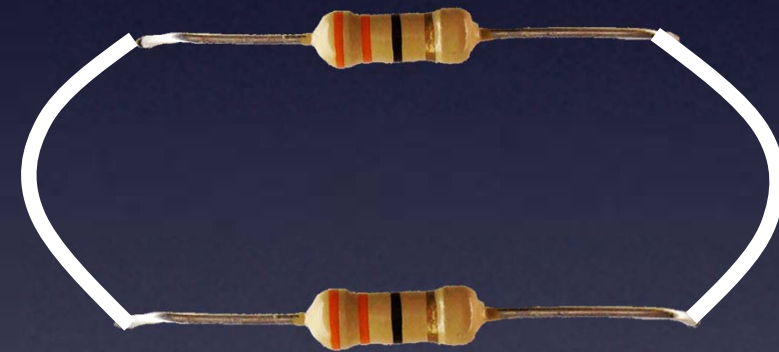

Parallel = across

Everything You Need to Know About Electronics

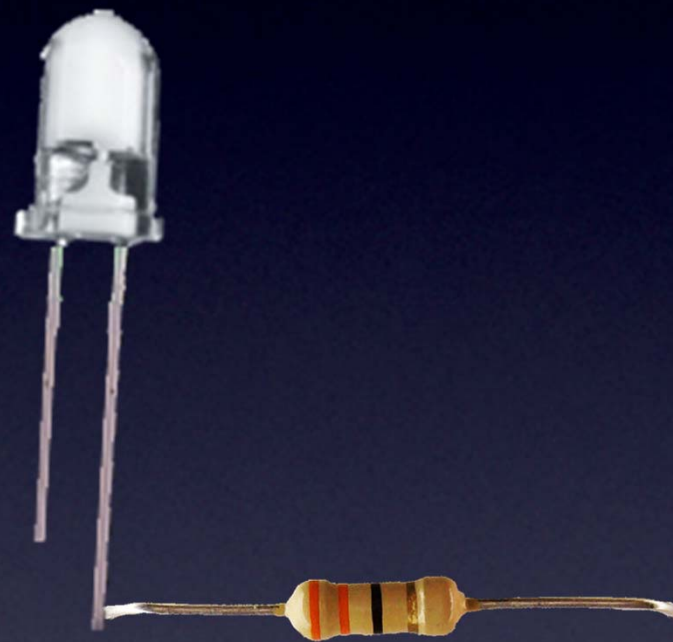

Let's make this light up!

LED

Everything You Need to Know About Electronics

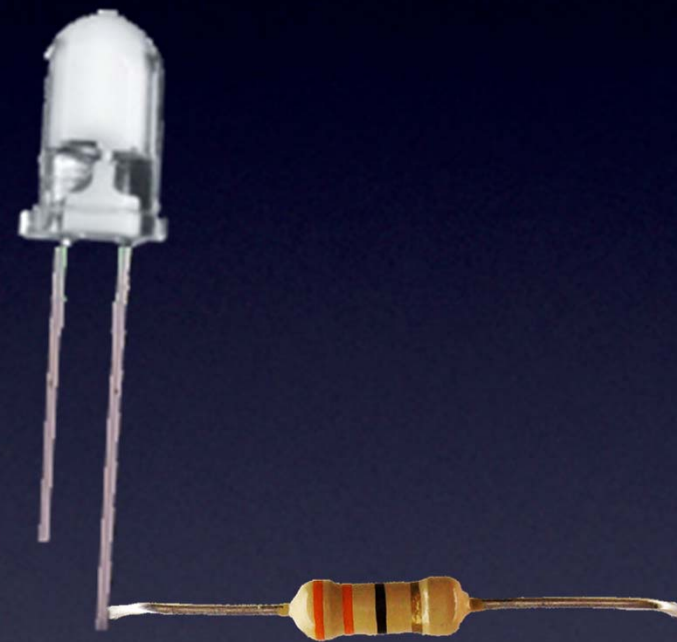

(add a power supply)

Let's make this light up!

LED

Everything You Need to Know About Electronics

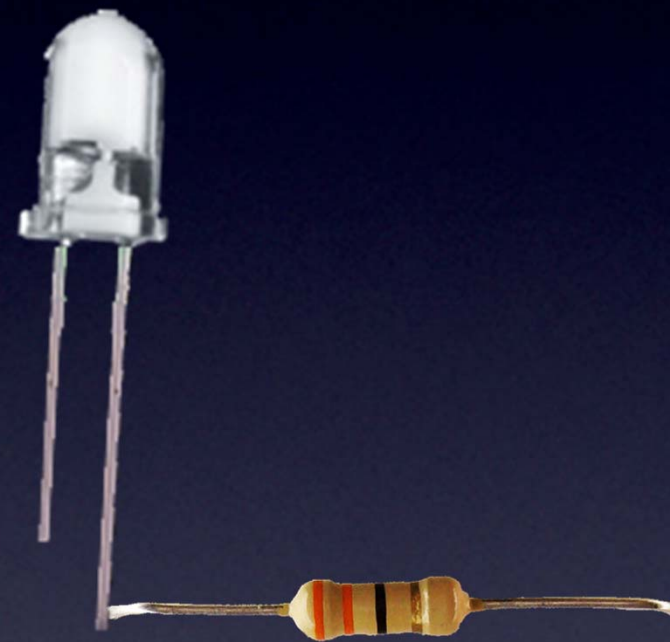
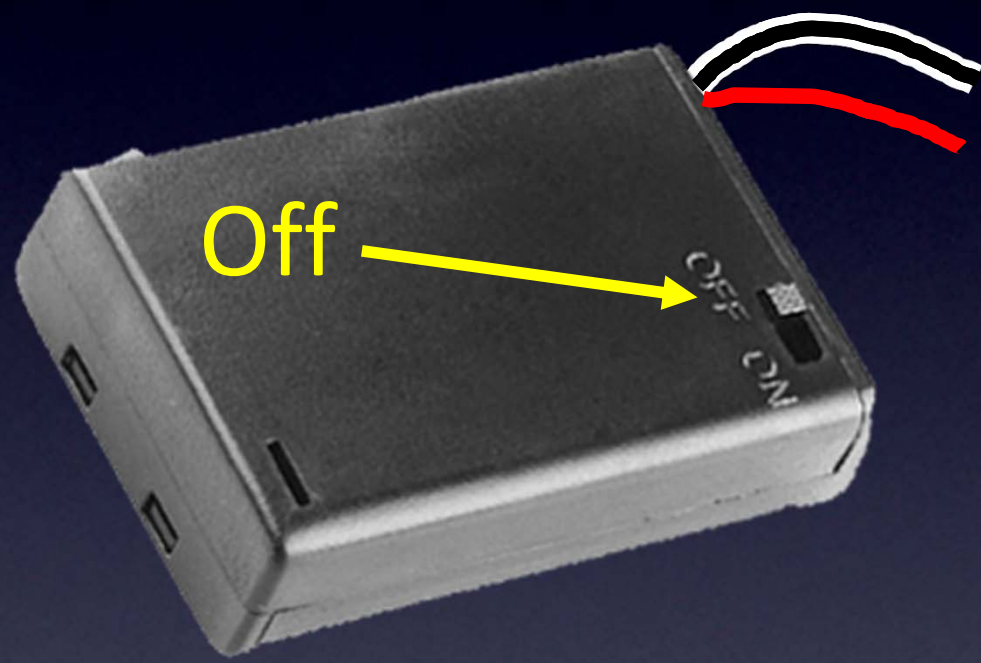

Let's make this light up!

LED

Everything You Need to Know About Electronics

Black wire: “-” (ground)



Red wire: “+” power)

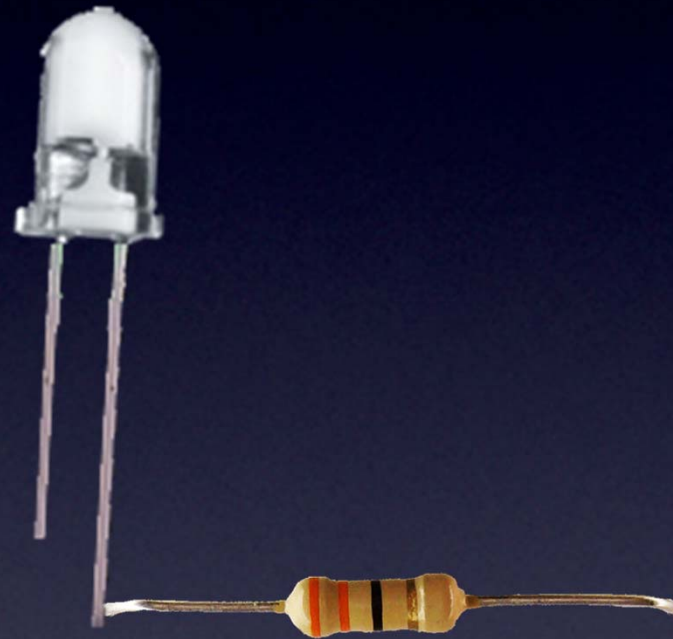

Let's make this light up!

LED

Everything You Need to Know About Electronics

short lead: “-”

Black wire: “-” (ground)



long lead: “+”

Red wire: “+” power)

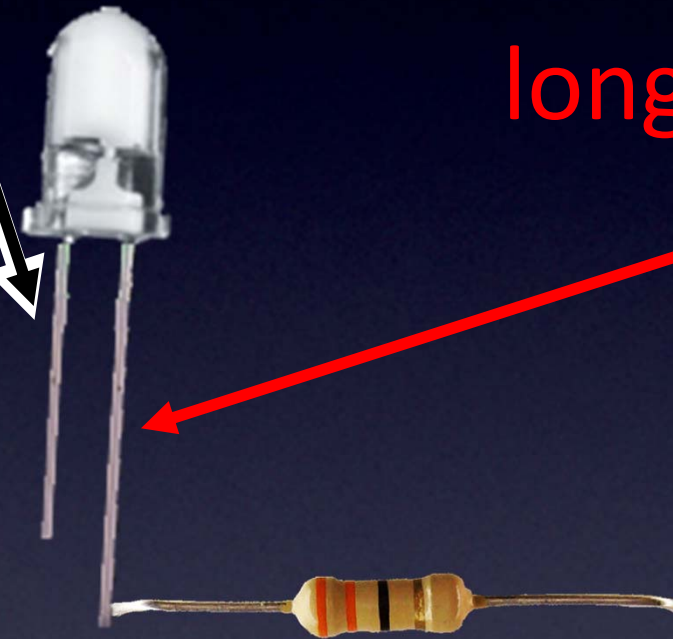

Let's make this light up!

LED

Everything You Need to Know About Electronics

short lead: “-”

Black wire: “-” (ground)

long lead: “+”

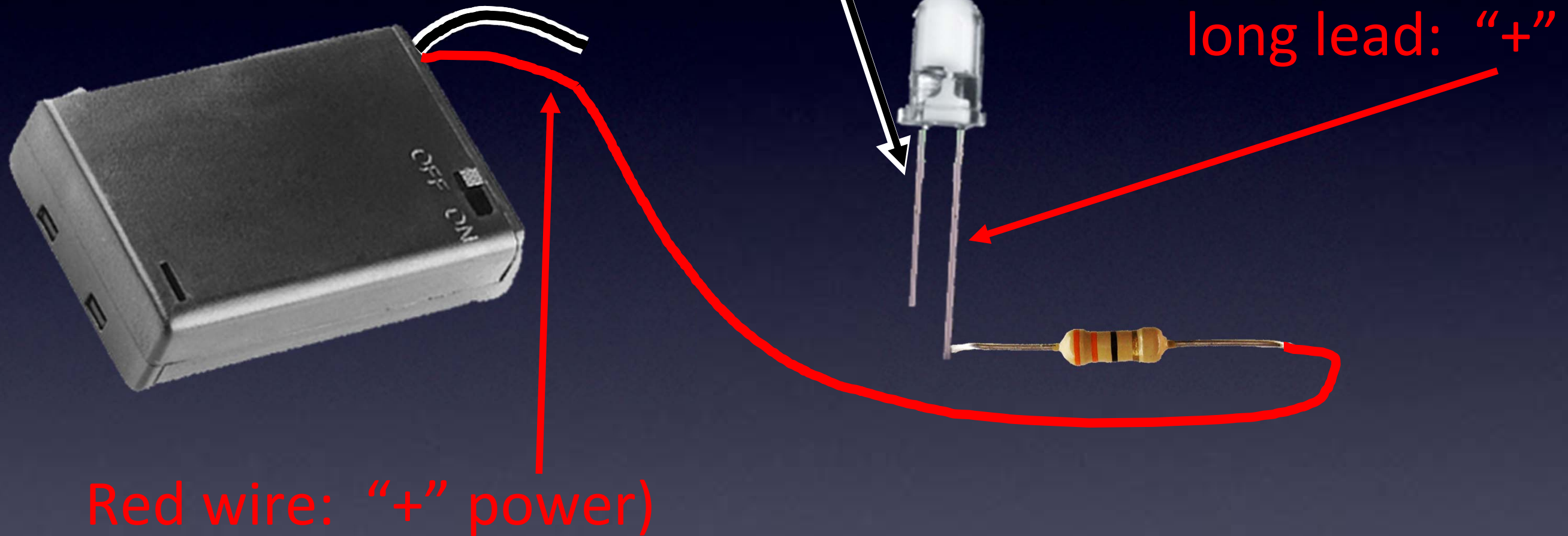

Let's make this light up!

LED

Everything You Need to Know About Electronics

short lead: “-”

Black wire: “-” (ground)

long lead: “+”

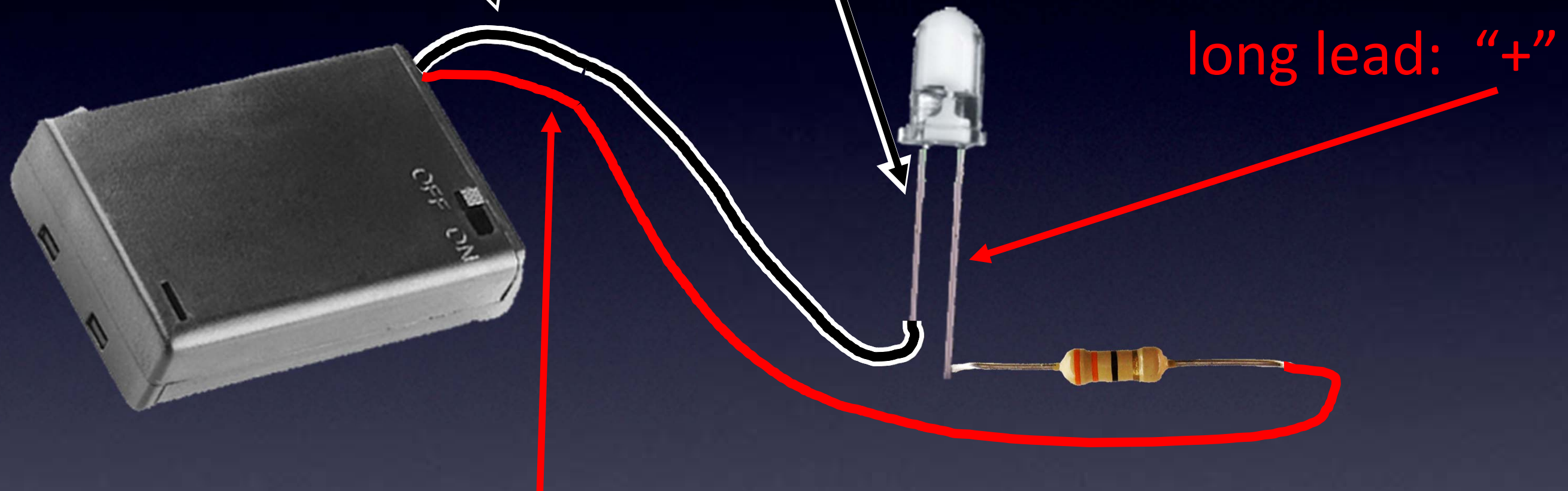

Red wire: “+” power)

Let's make this light up!

LED

Everything You Need to Know About Electronics

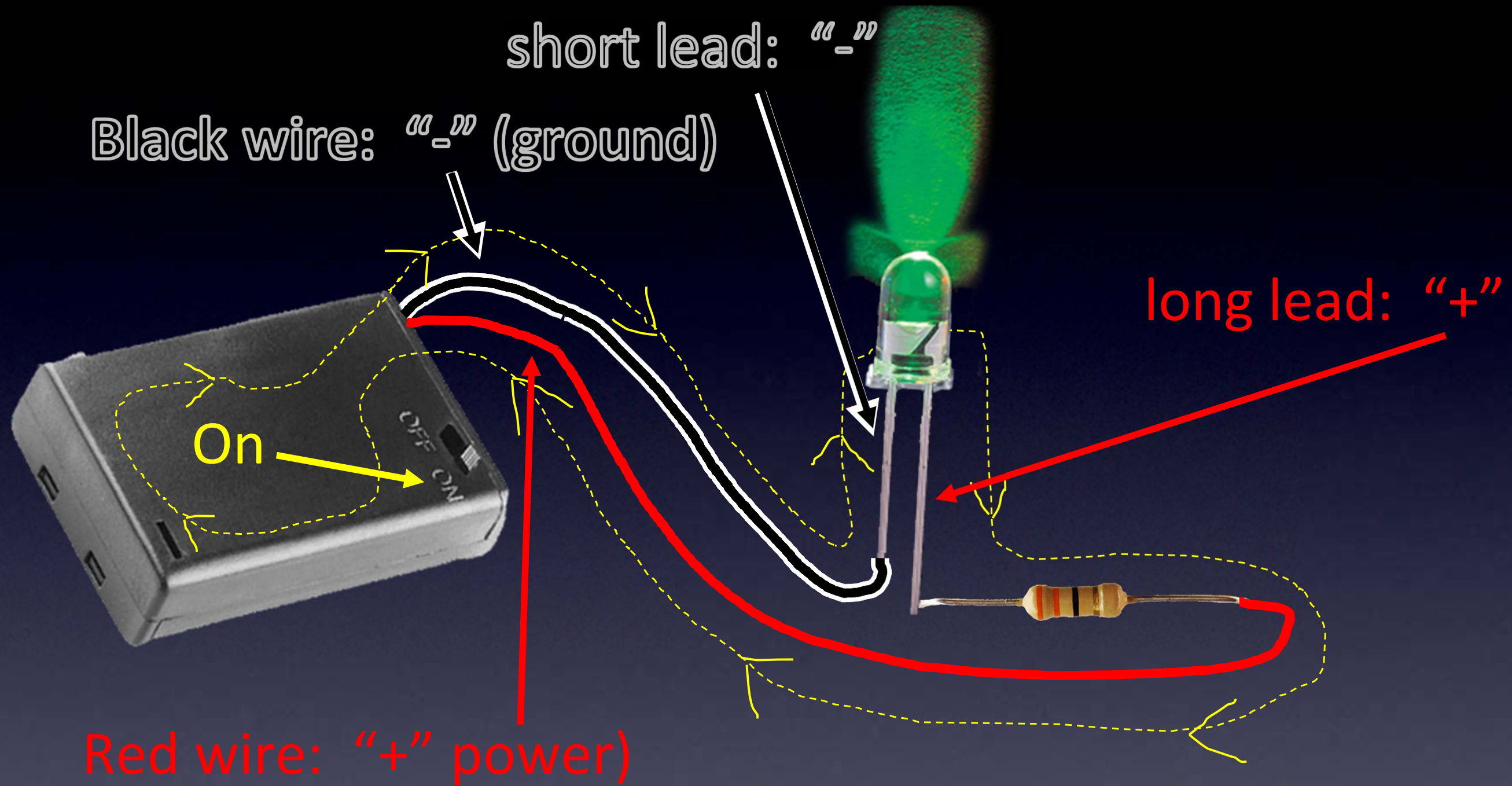

It lights!

LED

Everything You Need to Know About Electronics

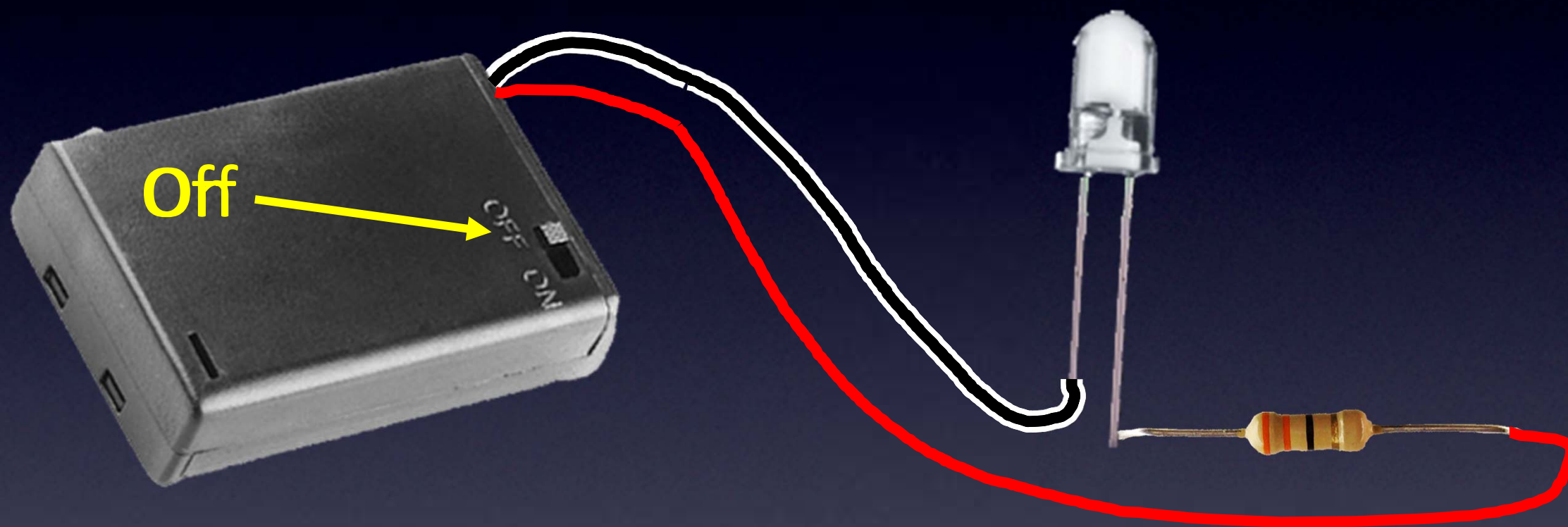

It's off

LED

Everything You Need to Know About Electronics

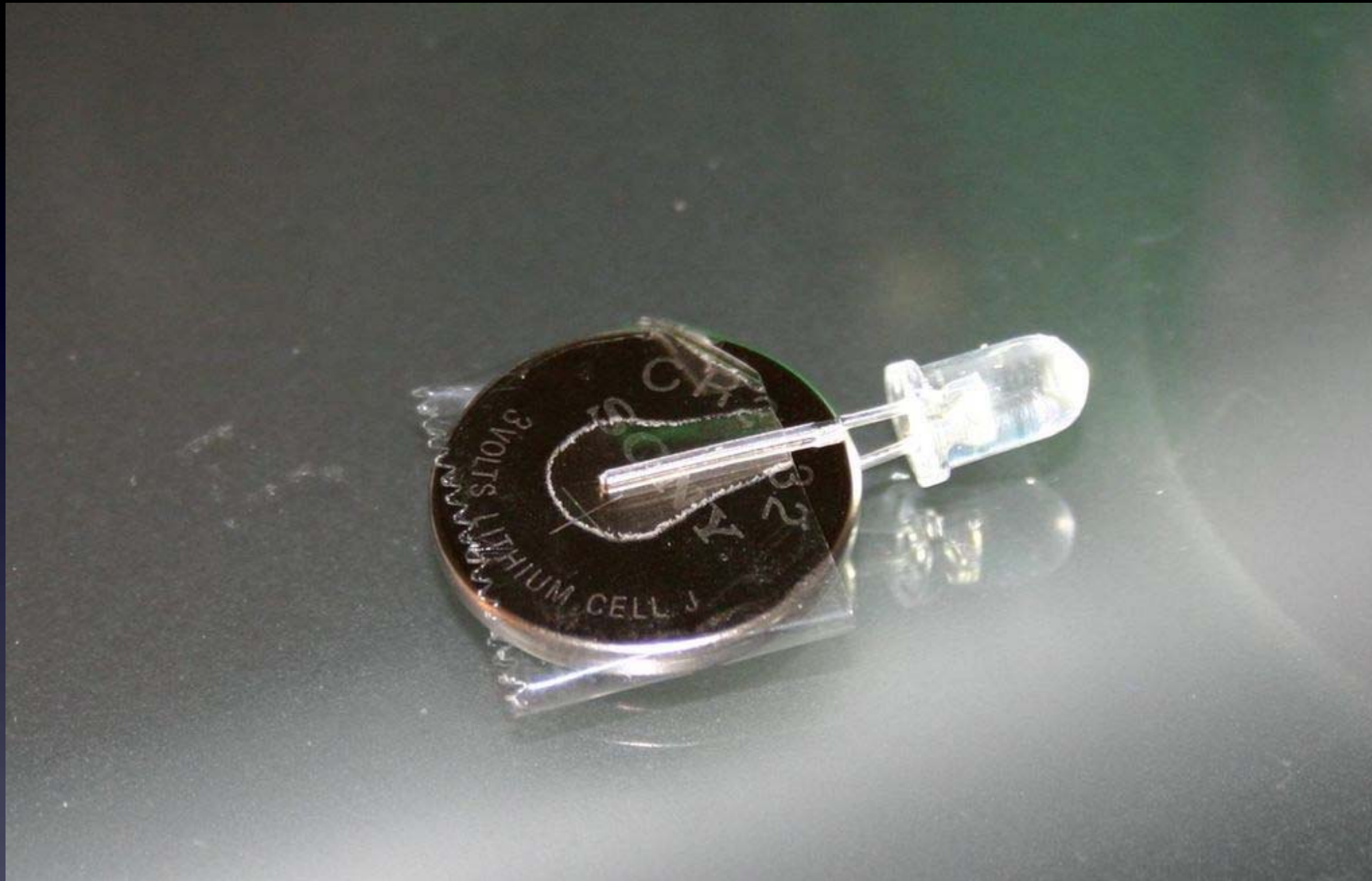

LED & battery

Our first circuit

Everything You Need to Know About Electronics

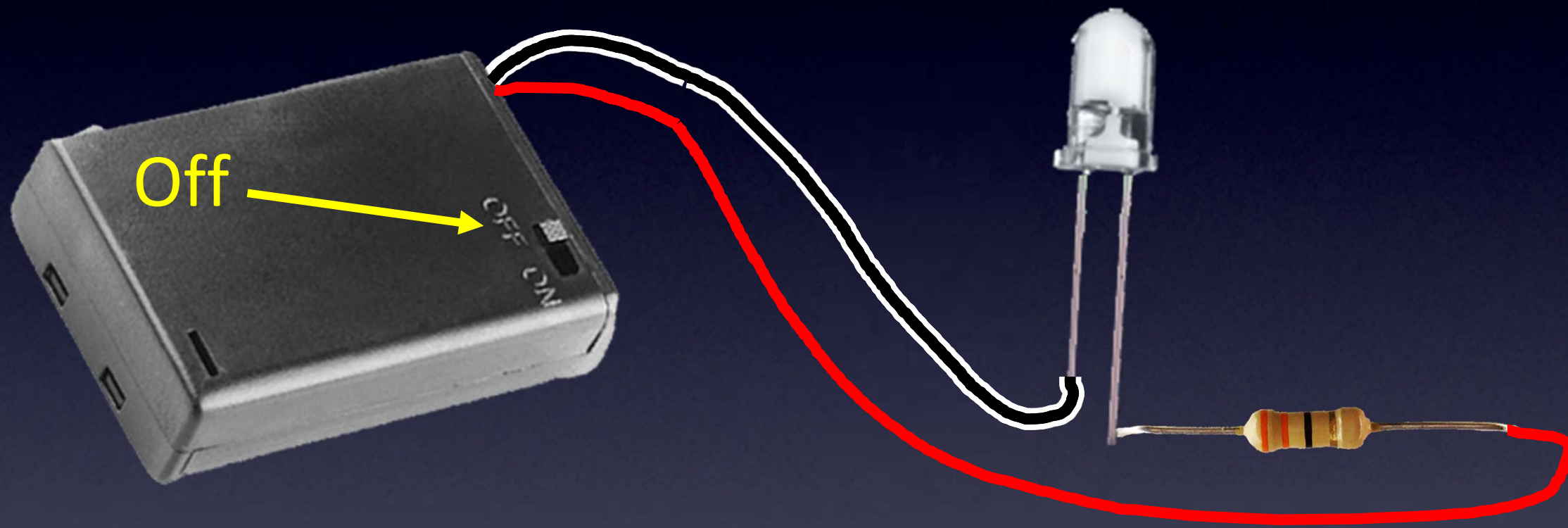

IR LED

Everything You Need to Know About Electronics

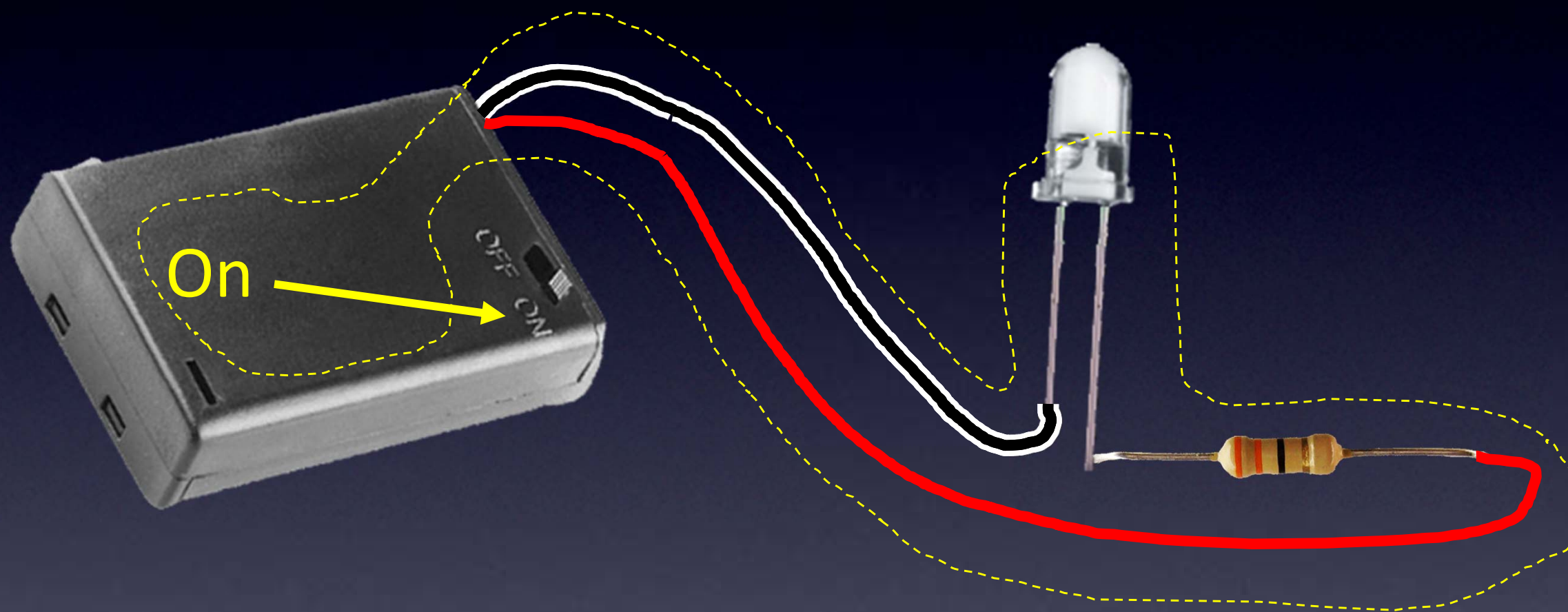

IR LED

Everything You Need to Know About Electronics

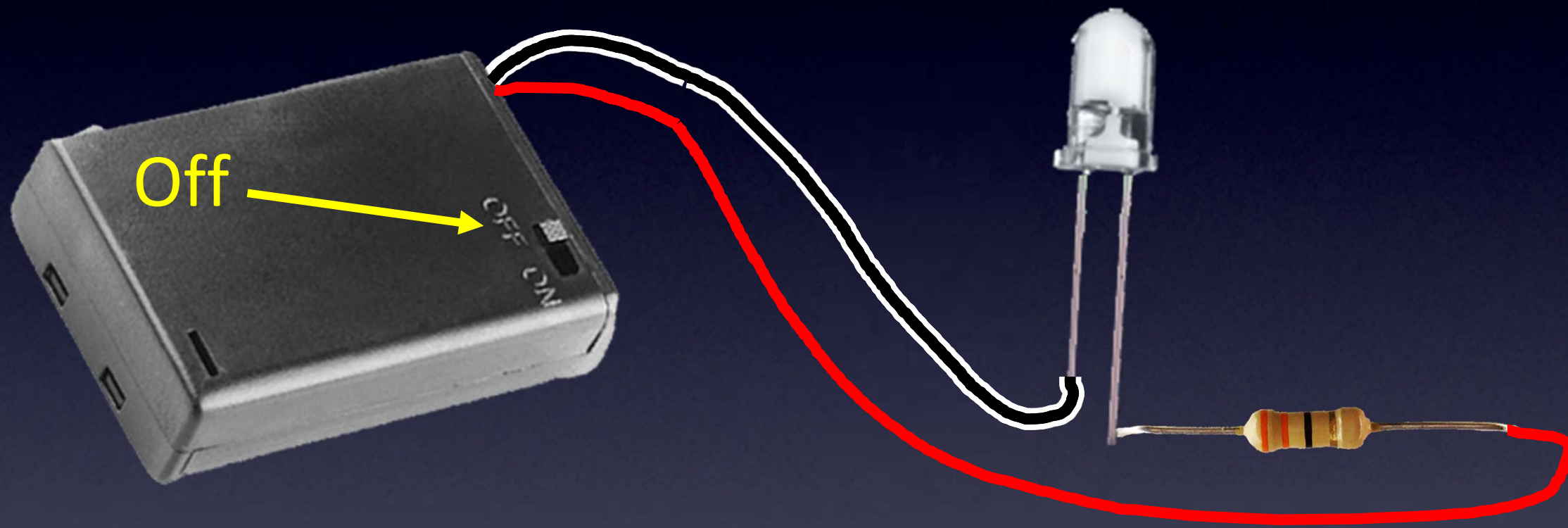

IR LED

Everything You Need to Know About Electronics

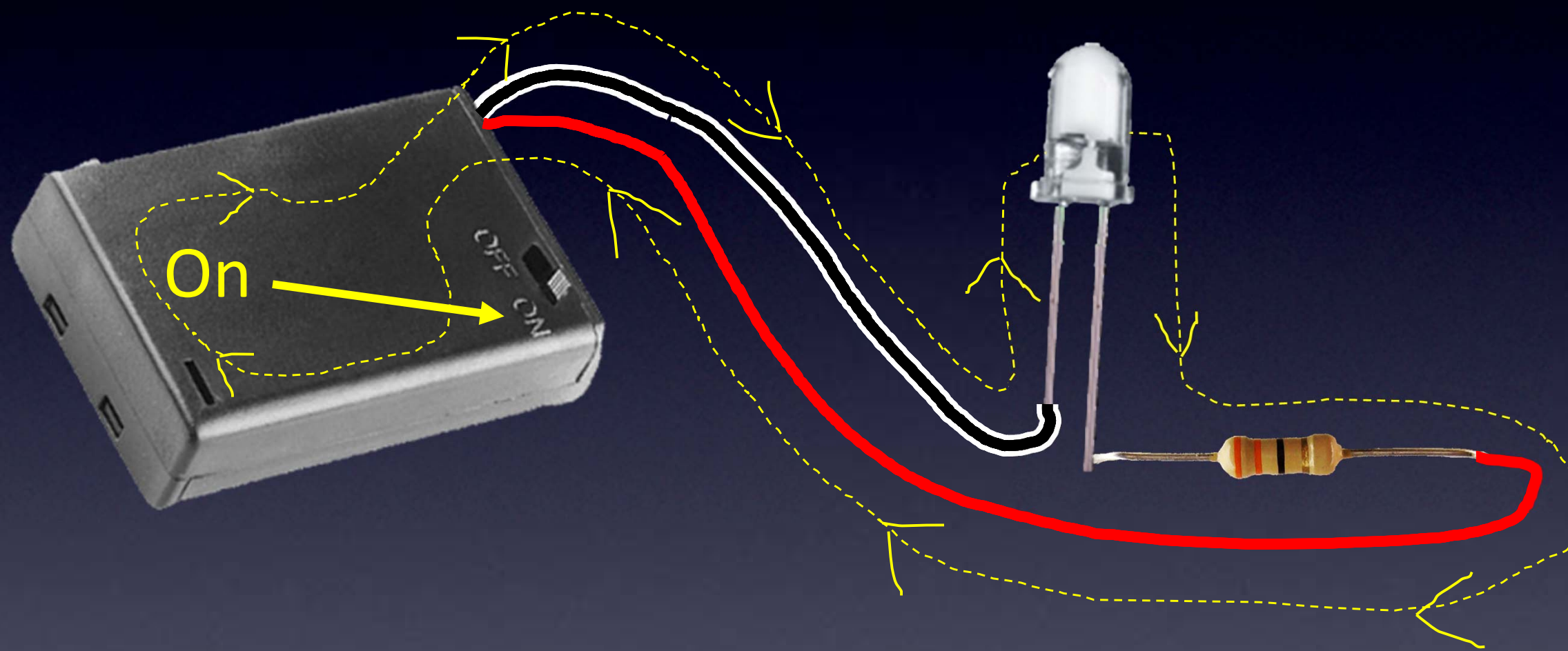

IR LED

Everything You Need to Know About Electronics

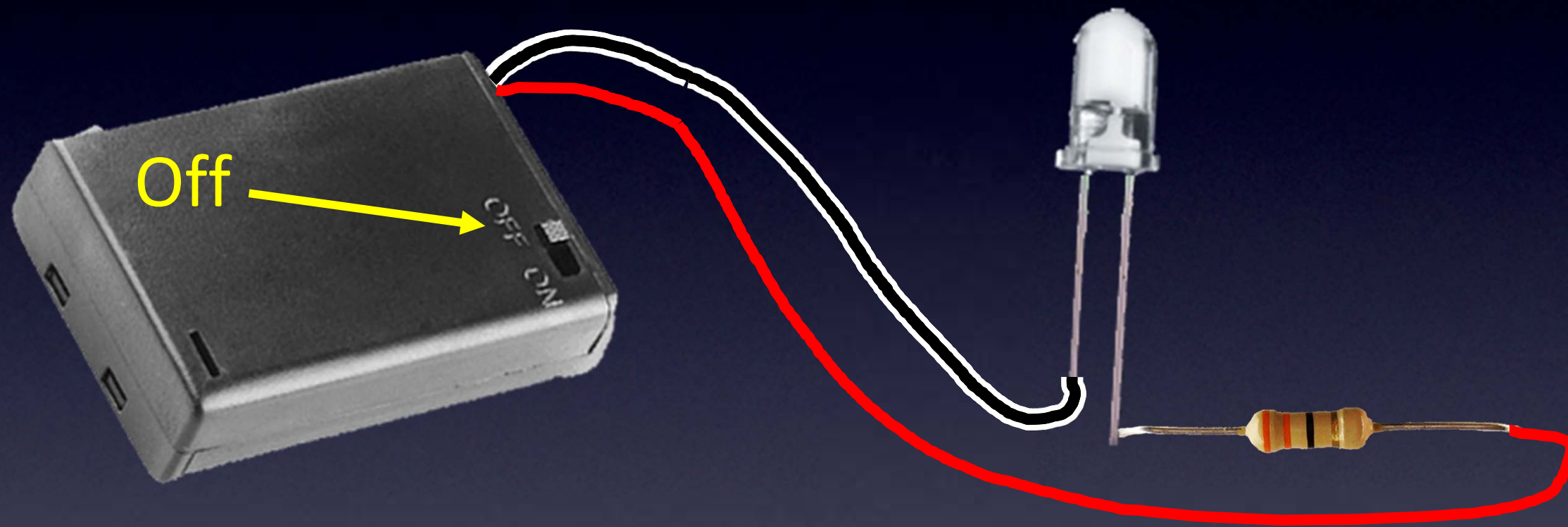

A “code” is IR light blinking on-off-on-off...

IR Remote Control

Everything You Need to Know About Electronics

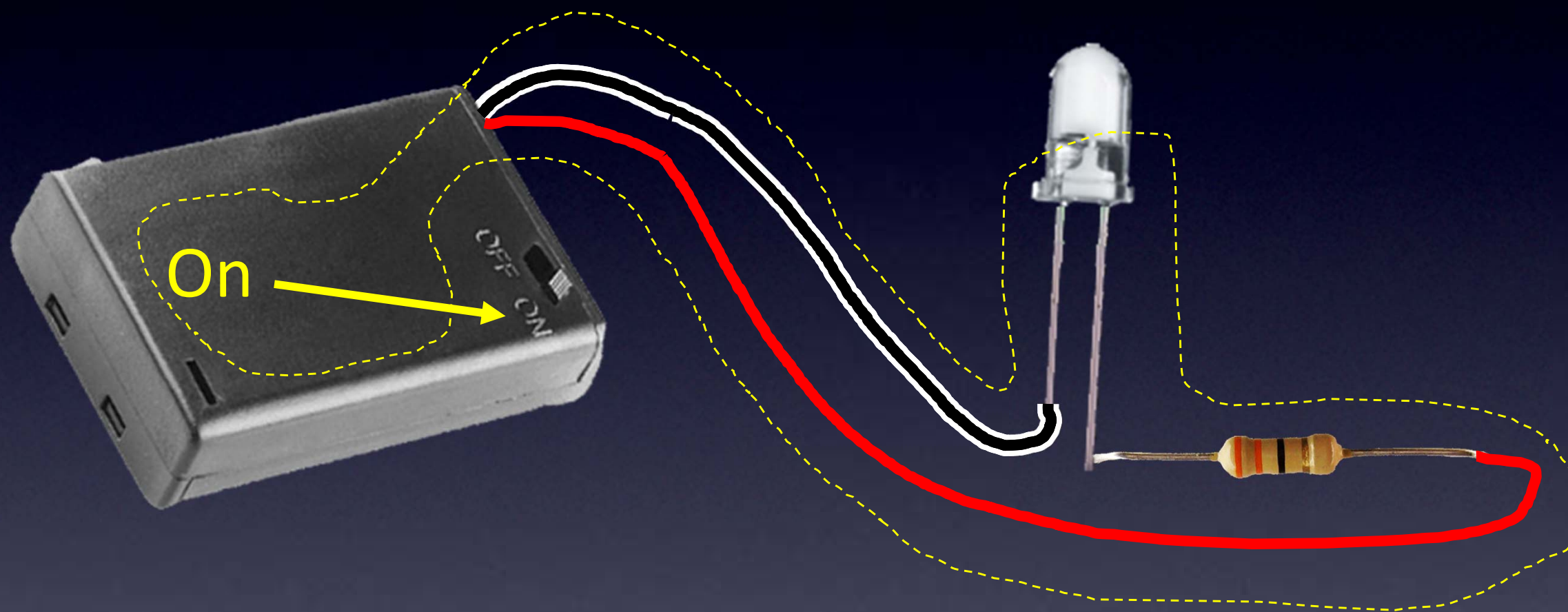

A “code” is IR light blinking on-off-on-off...

(we can't do this, but microcontrollers can!)

IR Remote Control

Everything You Need to Know About Electronics

Takes about 60 seconds

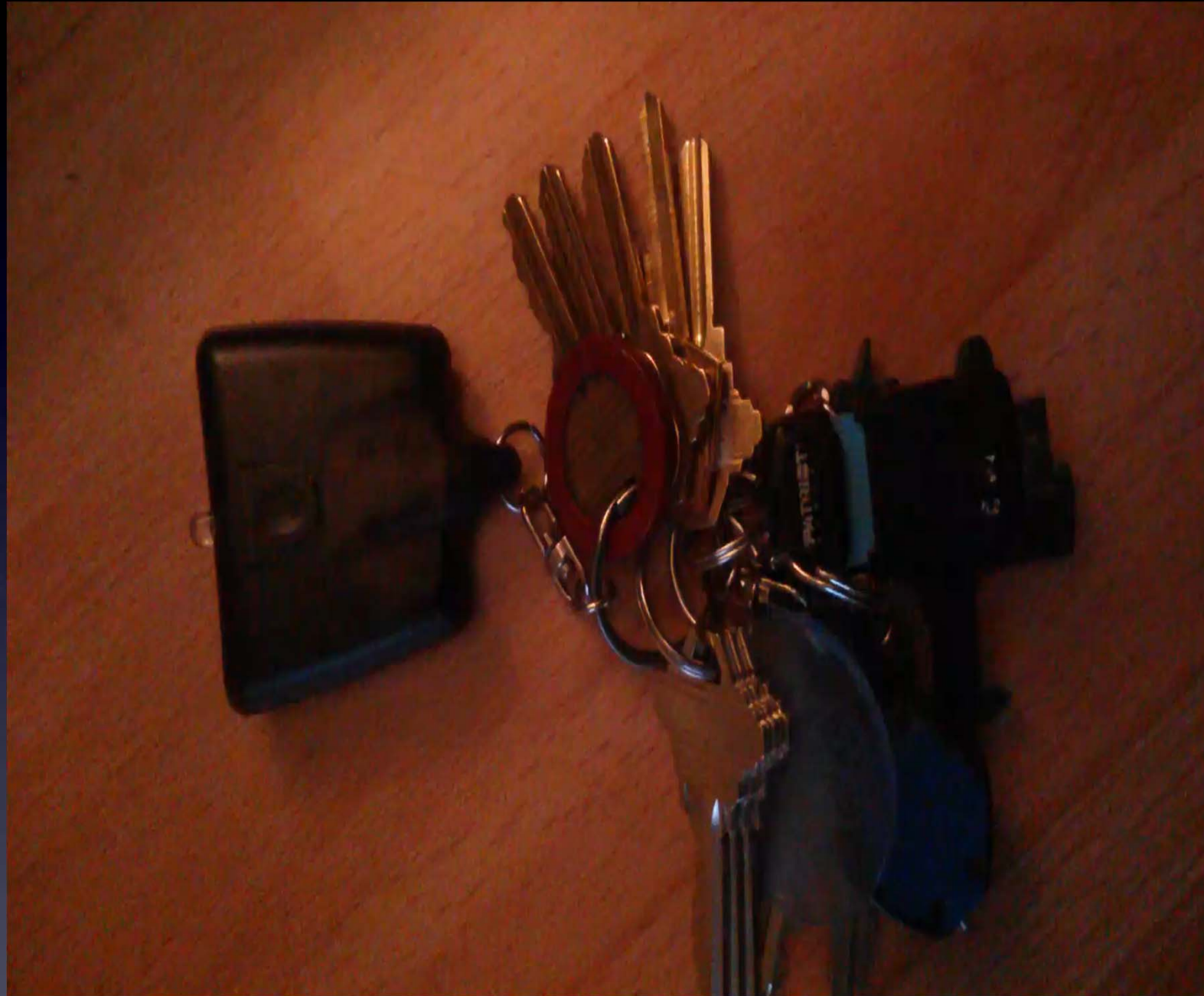

About 150 IR "OFF" codes (one per blink)

TV-B-Gone universal remote control

Everything You Need to Know About Electronics

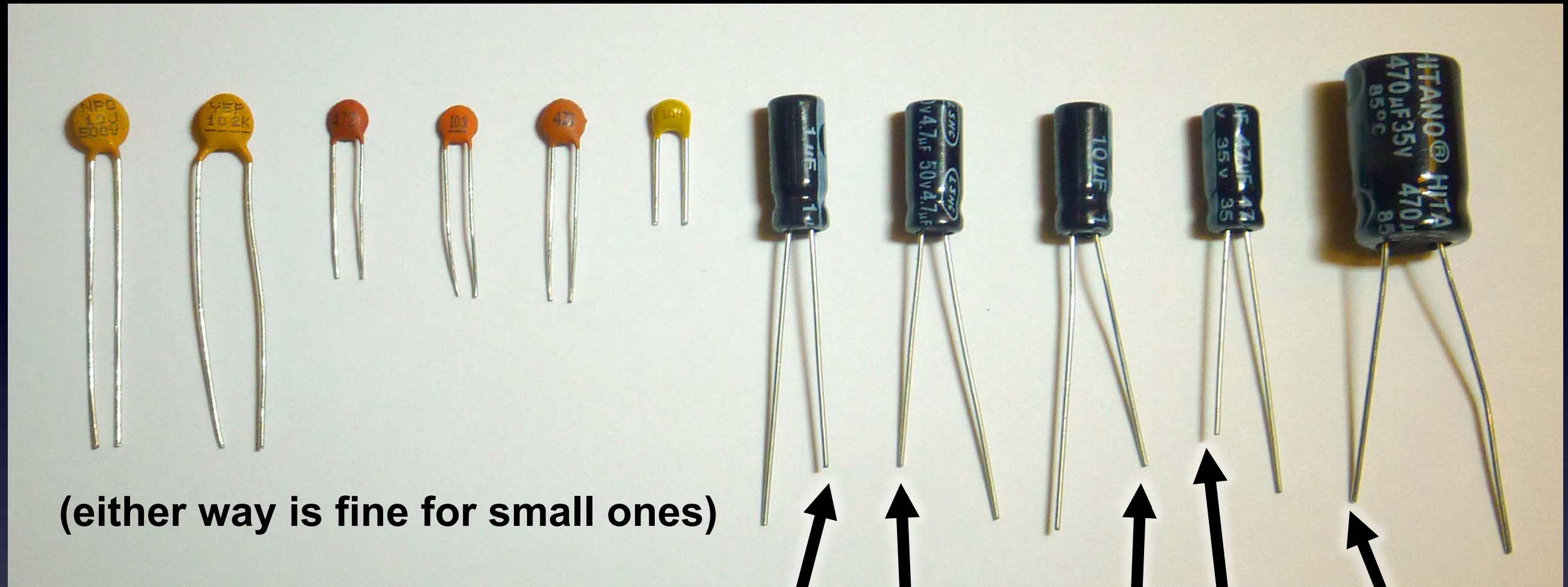

Short wire is Minus / Negative

Little buckets for electrons

Capacitor / Farads

Everything You Need to Know About Electronics

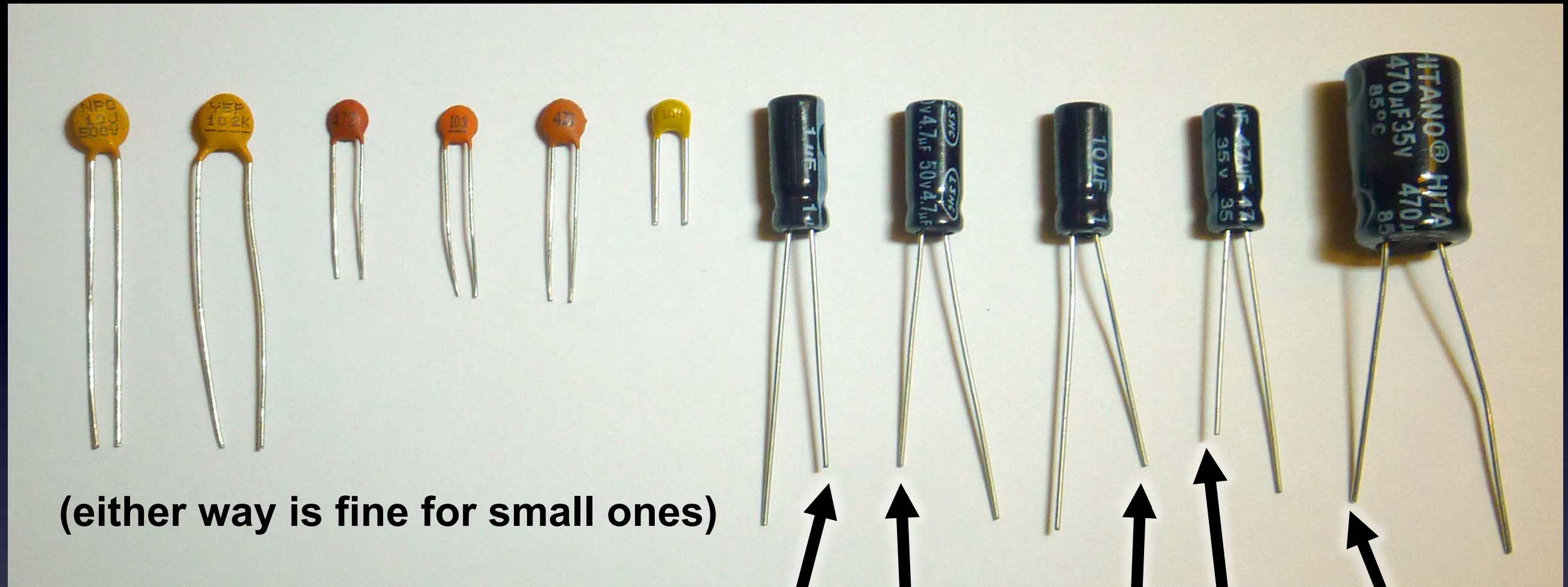

(either way is fine for small ones)

Short wire is Minus / Negative

Little buckets for electrons

Capacitor / Farads

Everything You Need to Know About Electronics

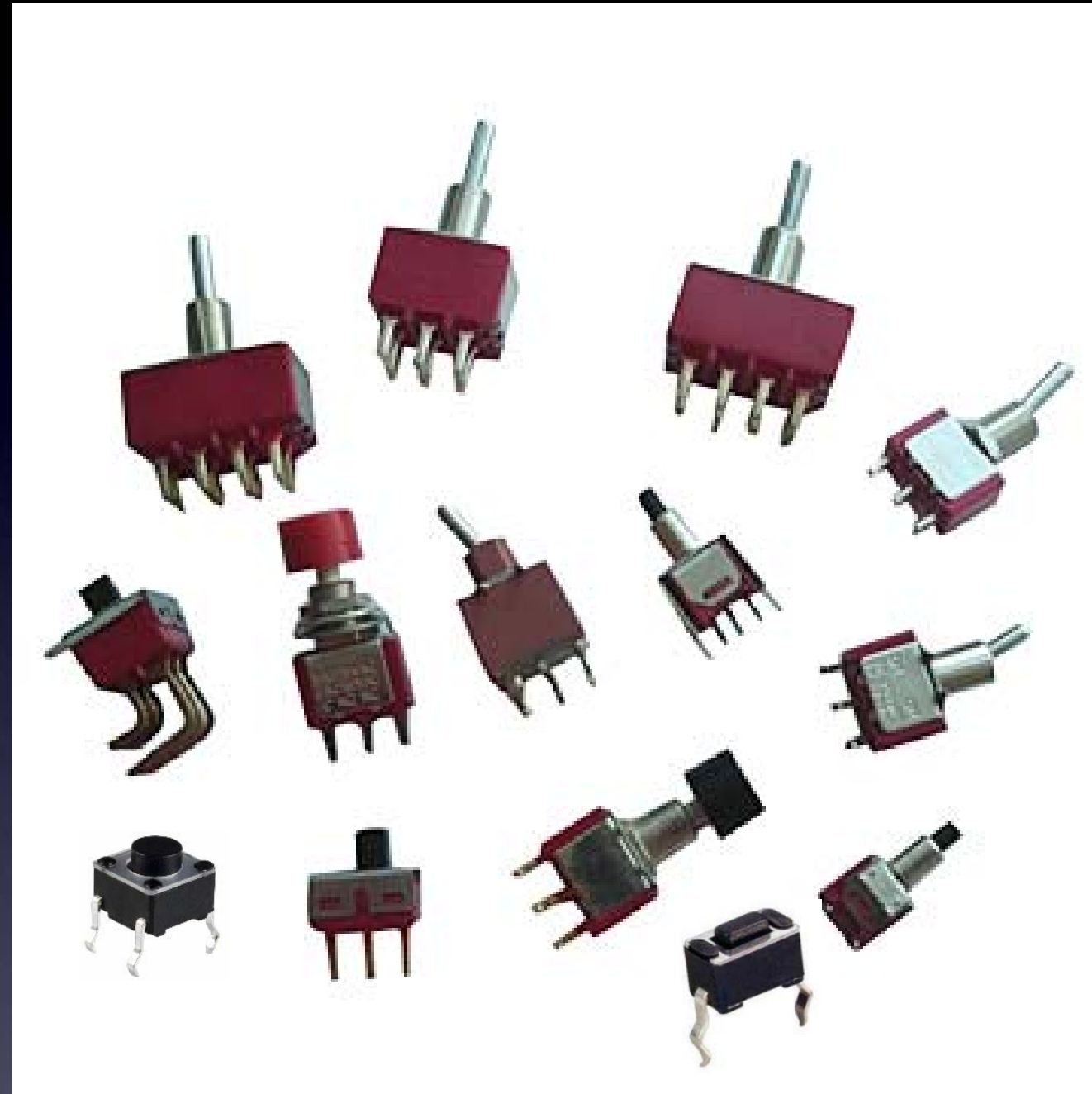

Strips of metal connected together – or not

Switch

Everything You Need to Know About Electronics

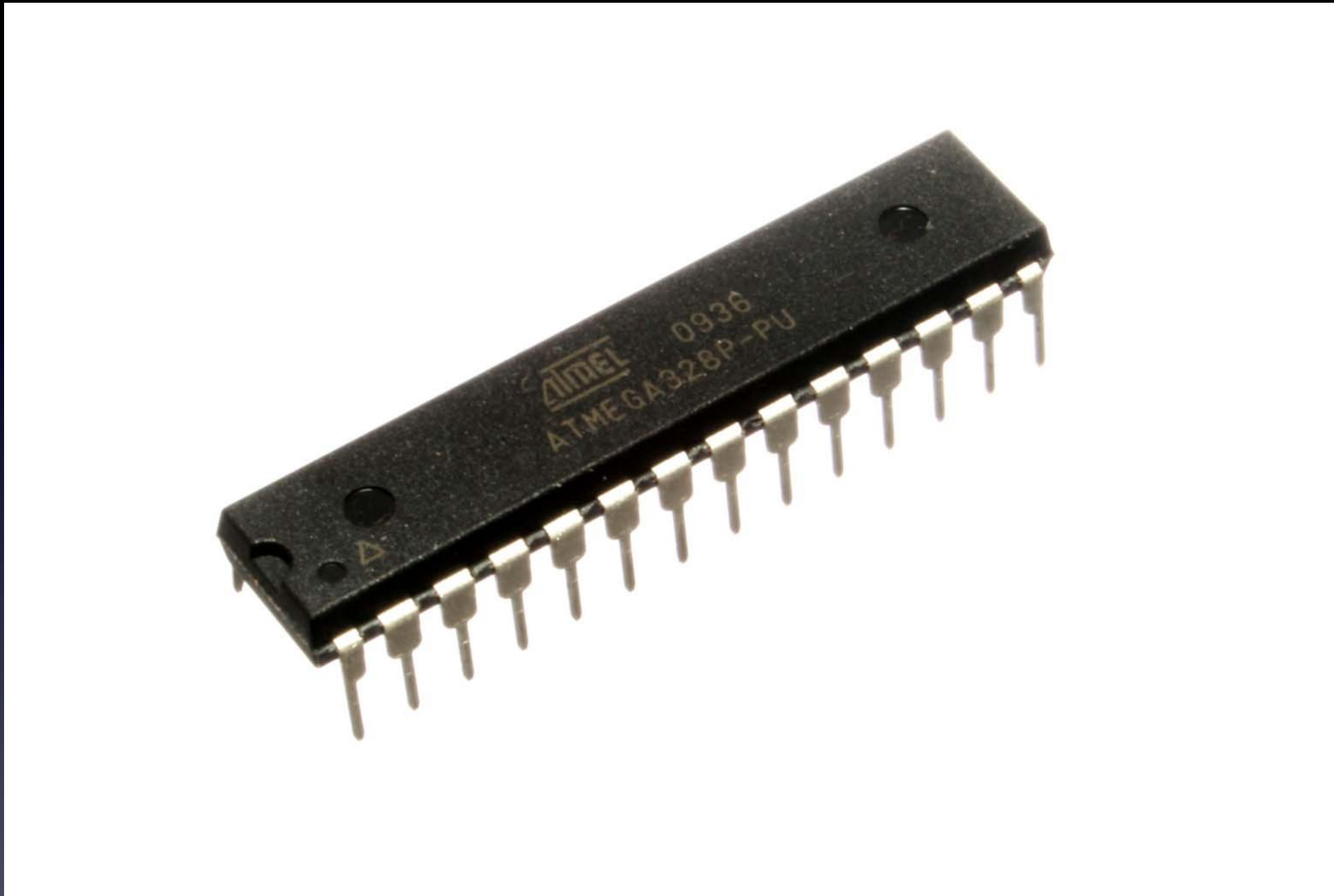

A complete computer on a chip

Microcontroller

Everything You Need to Know About Electronics



that control electronic parts connected to its pins.

Microcontroller

Everything You Need to Know About Electronics

2 special pins:

Pin 1

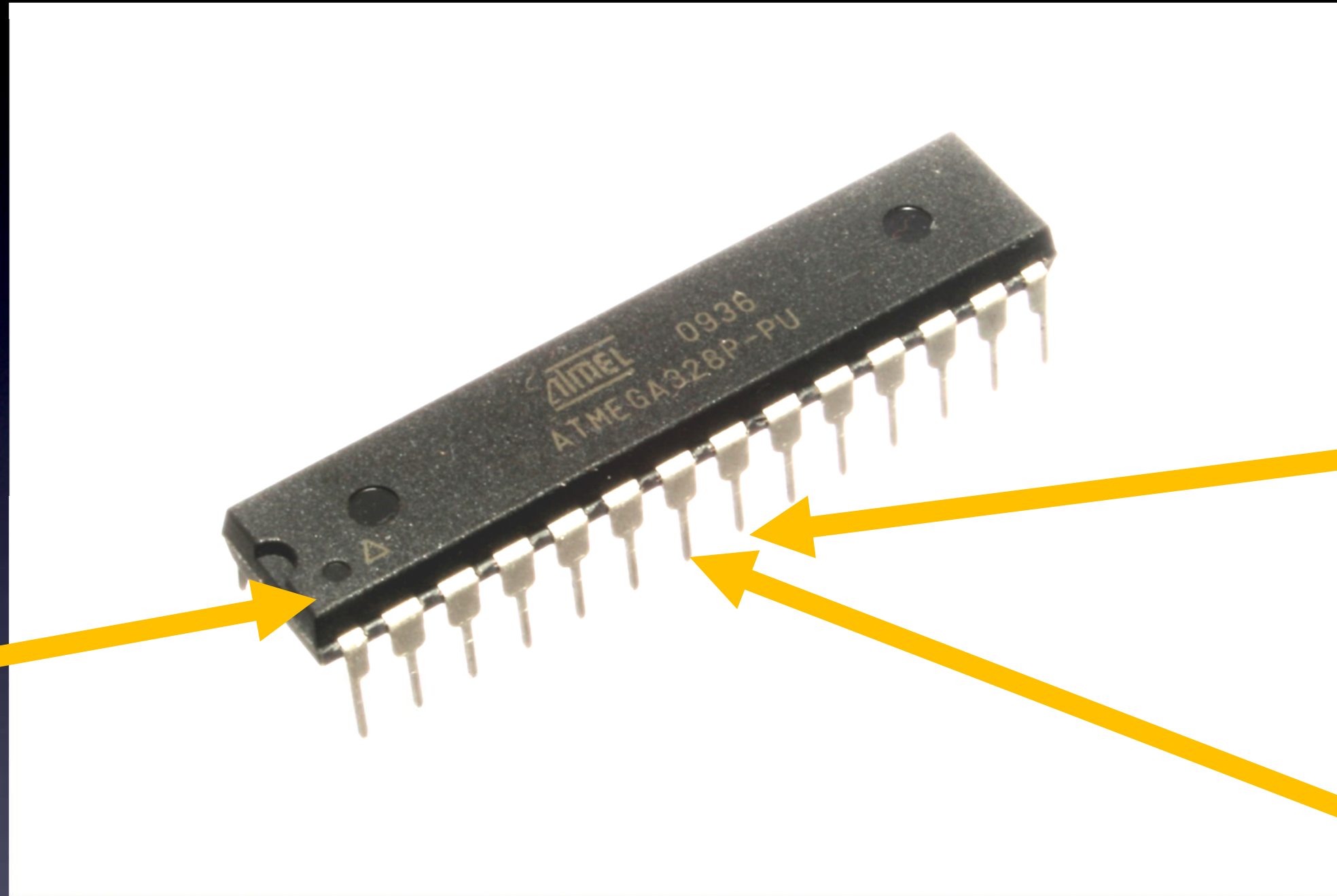

Pin 8 = Ground

Pin 7 = Vcc

A complete computer on a chip

Microcontroller – it matters how you hook it up!

Everything You Need to Know About Electronics

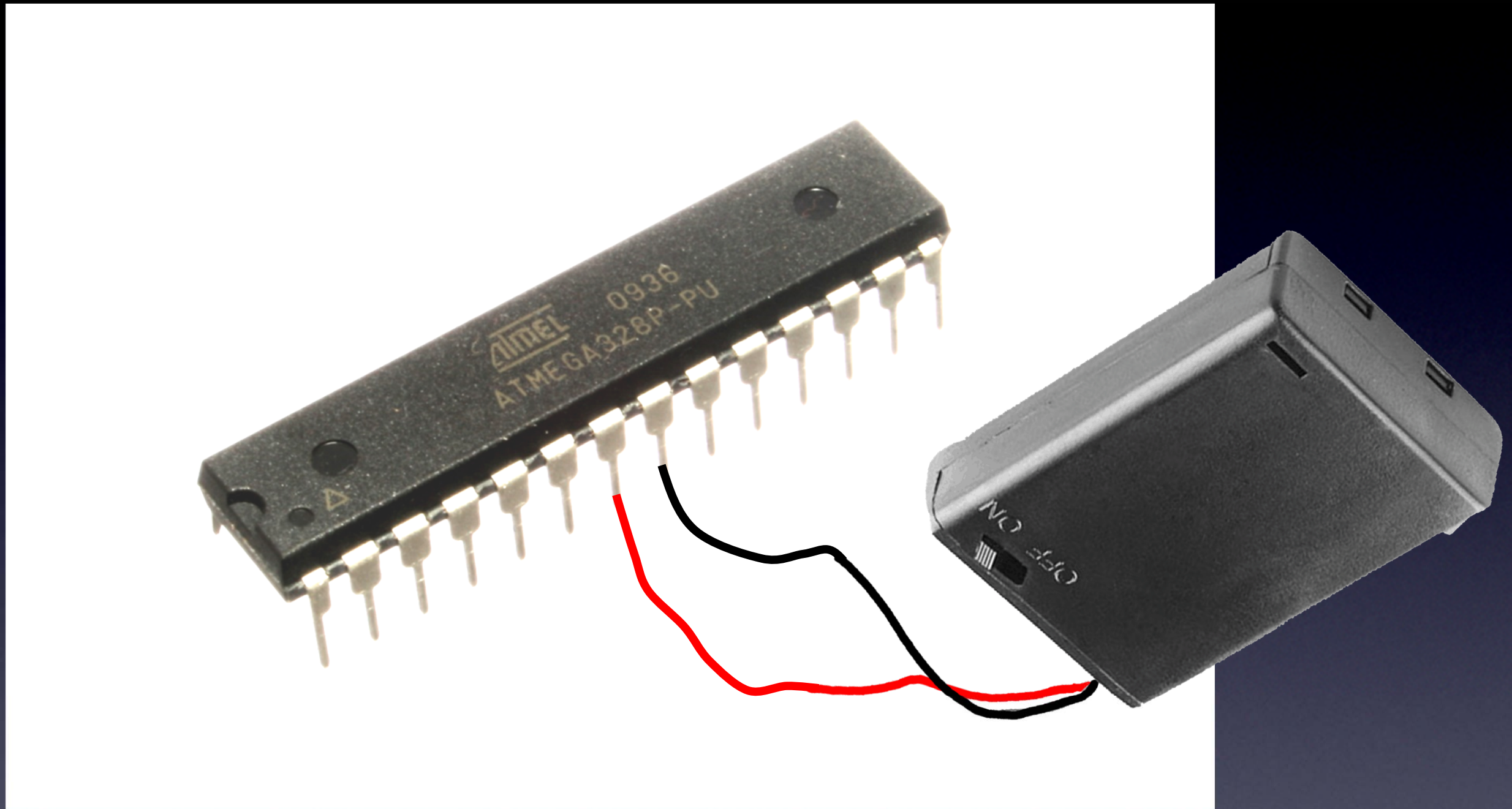

A complete computer – running a program!

Microcontroller – turned on!

Everything You Need to Know About Electronics

**all other pins are
Input pins
or
Output pins**

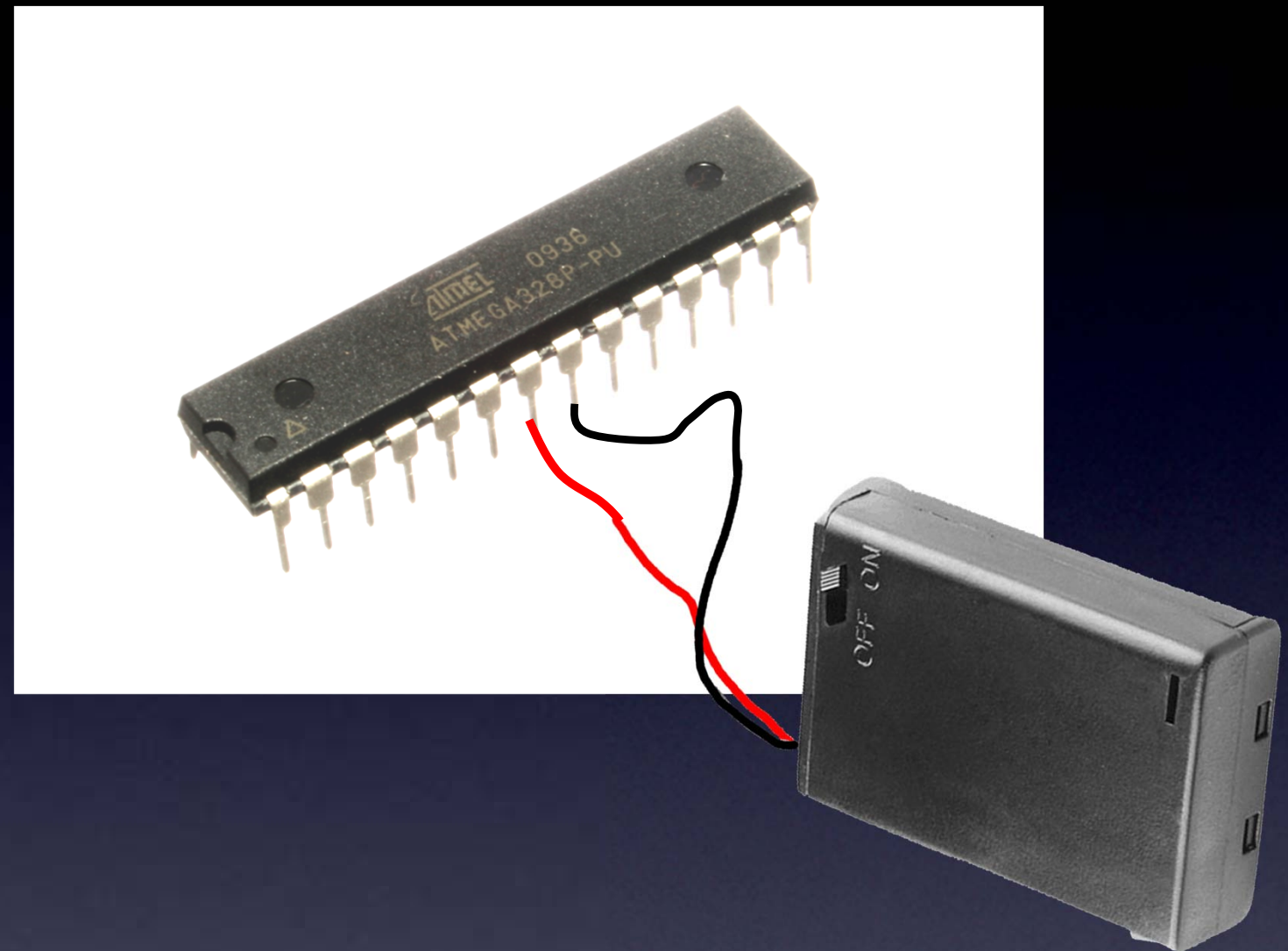

**Your program controls electronics parts
on these other pins**

Microcontroller

Everything You Need to Know About Electronics

Analog Electronics:

Any voltage between Ground (0V) and Vcc

Digital Electronics:

Only 2 choices: Ground (0V) or Vcc

2 types of electronics

Everything You Need to Know About Electronics

Ground (0V)

Low

Off

0

(without Voltage / with Voltage)

(without current / with current)

Power / Vcc

High

On

1

Digital Electronics:

Only 2 choices: Ground (0V) or Vcc

Digital Electronics

Everything You Need to Know About Electronics

To make a pin an
Output pin

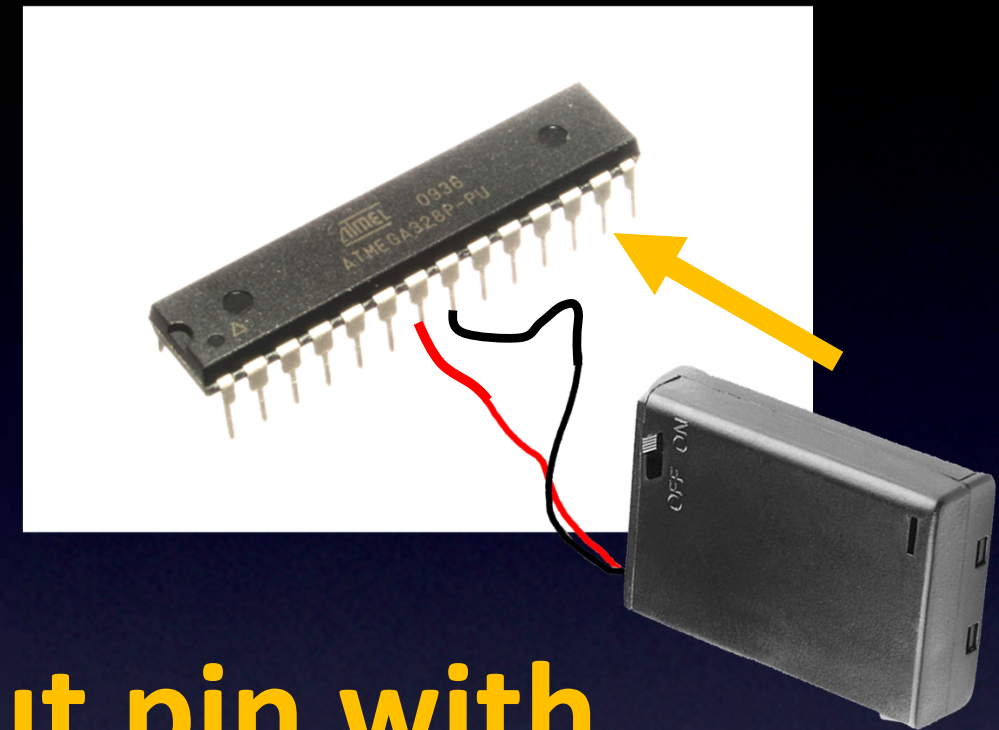

you tell it to become an **Output pin** with
a statement in your program

Let's tell pin 13 to be an **Output pin**

Microcontroller – Output pins

Everything You Need to Know About Electronics

Low

Off

(0V)

High

On

(Power supply voltage)

-- like the Red wire of our power supply

-- but controlled by our program!

Only 2 choices: High or Low

Microcontroller – Output pins

Everything You Need to Know About Electronics

A real world example

How to make an LED blink?

Hello World

Microcontroller

Everything You Need to Know About Electronics

Software

Type:

Hello World
on your screen

Microcontrollers

make an LED blink

Hello World

Microcontroller

Everything You Need to Know About Electronics

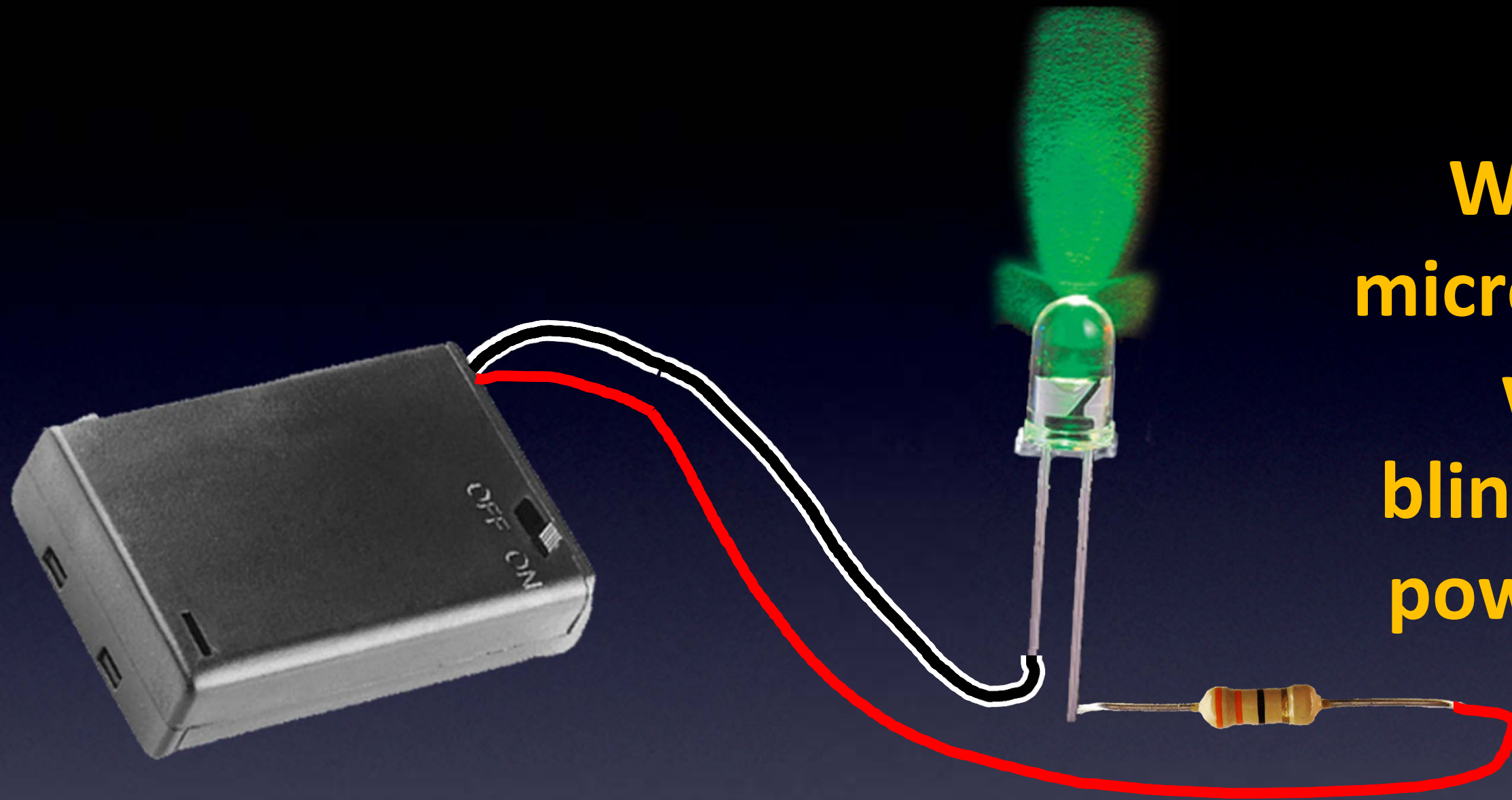

**Without a
microcontroller
we can
blink with our
power supply**

Turning an LED on and off

(Leading up to Hello World)

Everything You Need to Know About Electronics

**Let's replace
the power supply**

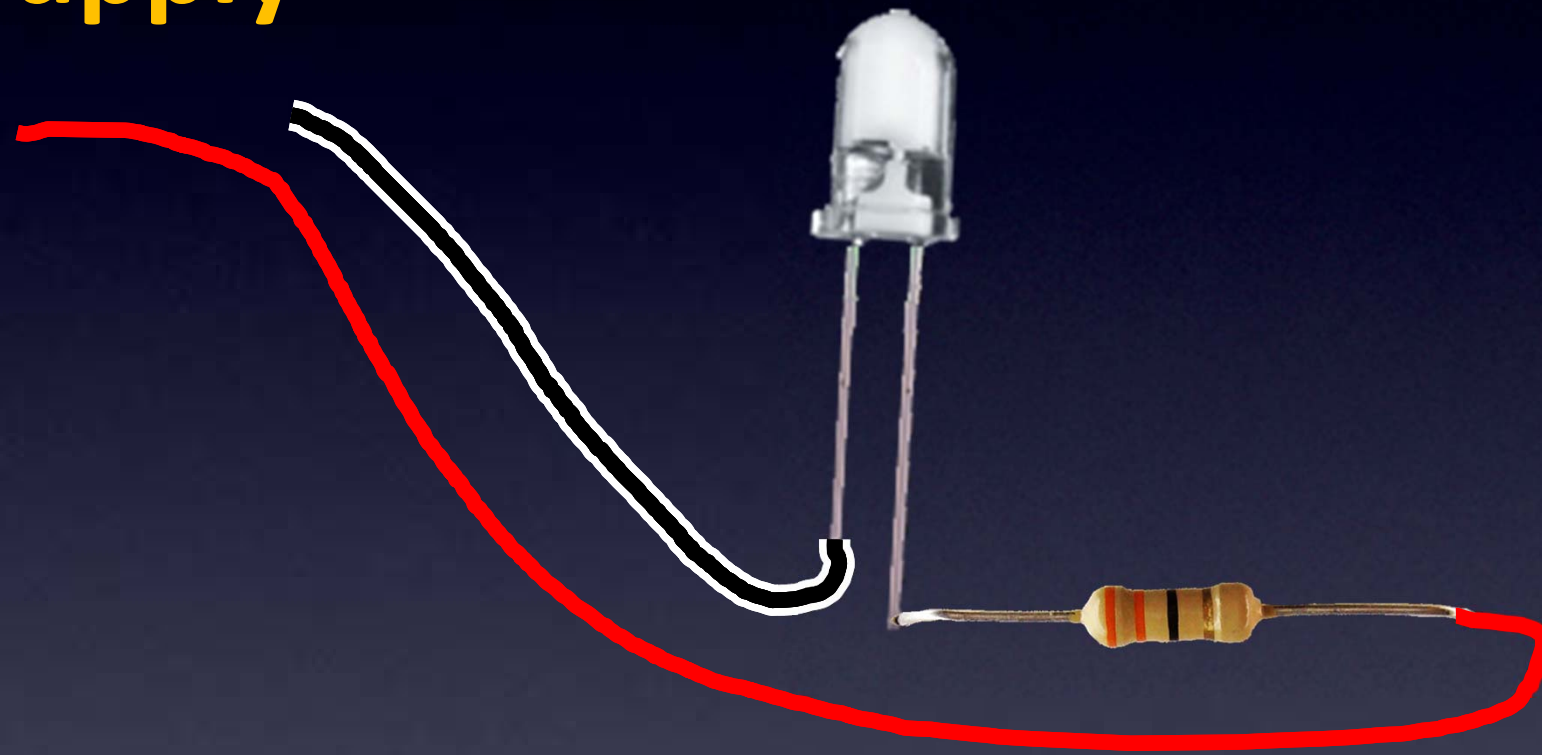

Turning an LED on and off

(Leading up to Hello World)

Everything You Need to Know About Electronics

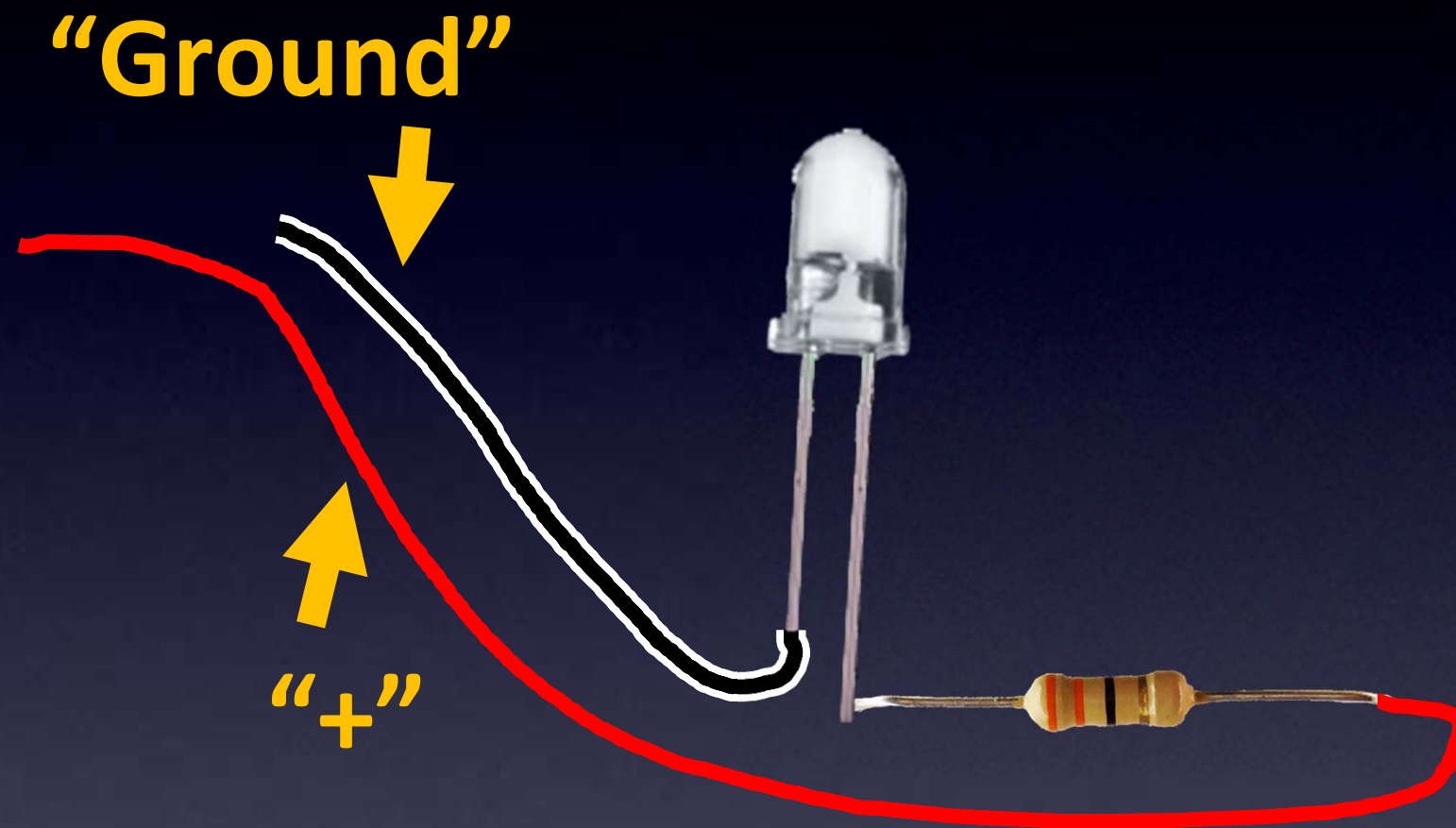

Turning an LED on and off

(Leading up to Hello World)

Everything You Need to Know About Electronics

We can use an
Output pin
(and Ground)
as our power
supply

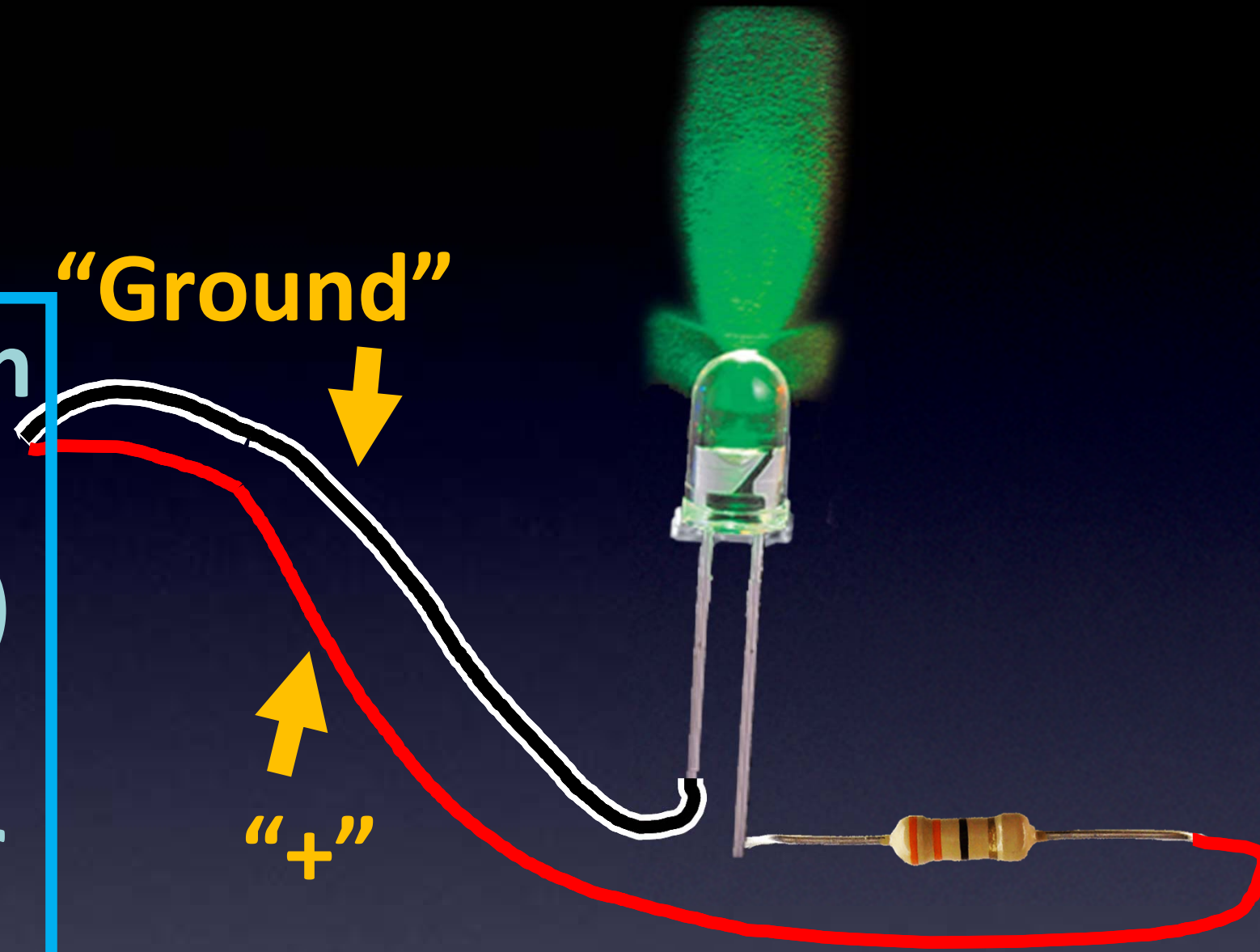

Turning an LED on and off

(Leading up to Hello World)

Everything You Need to Know About Electronics

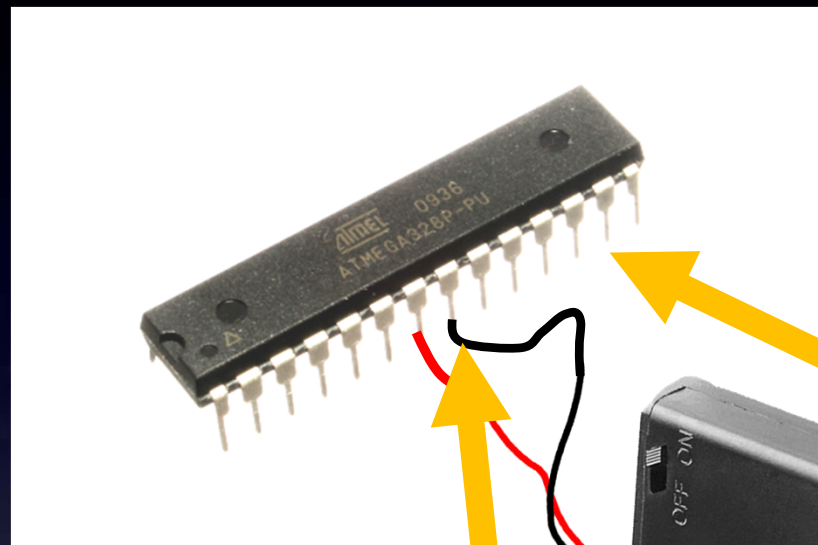

Ground

Pin 13

is our **Output pin**
(which can be On or Off)

Turning an LED on and off

(Leading up to Hello World)

Everything You Need to Know About Electronics

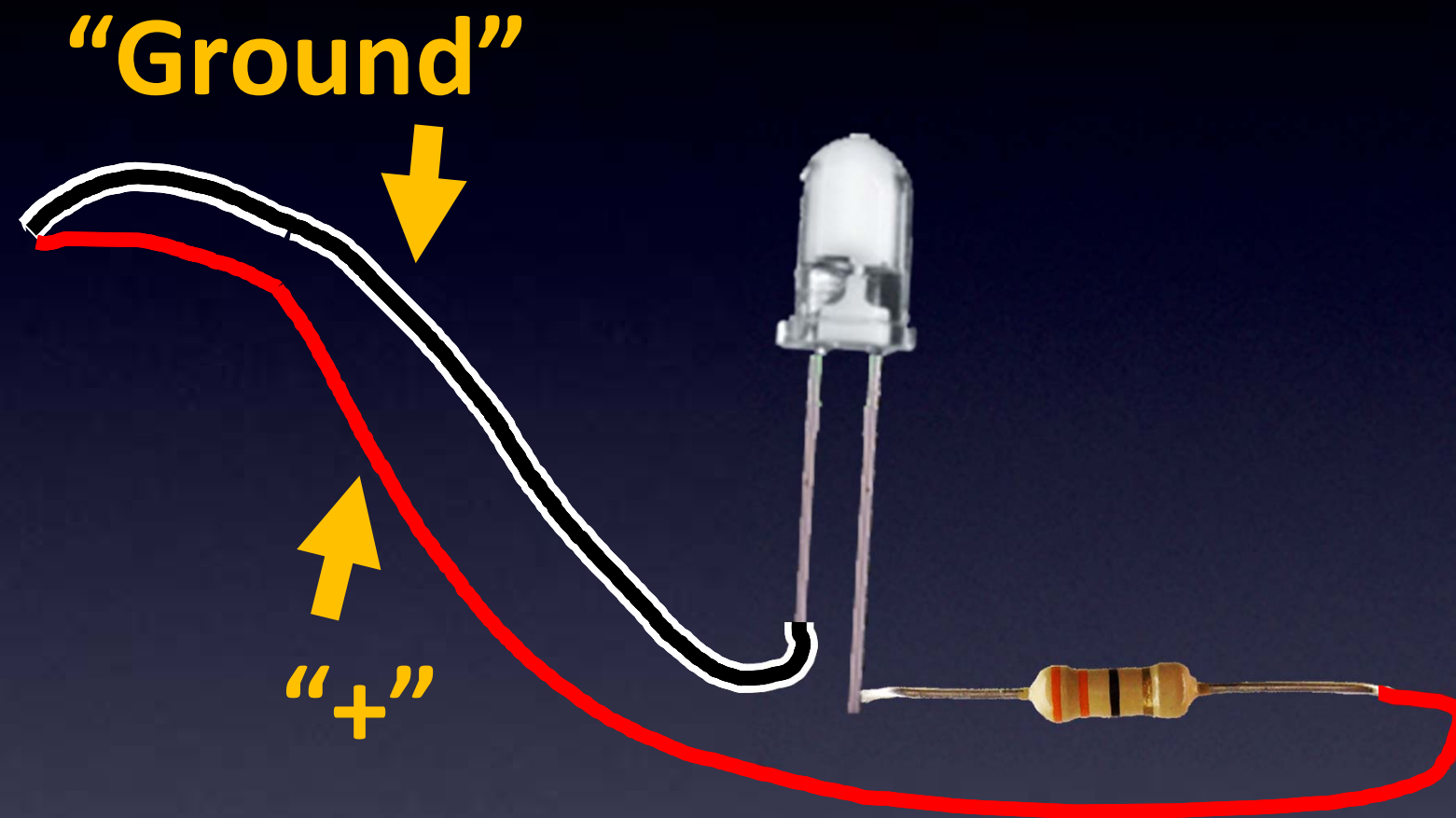

Turning an LED on and off

(Leading up to Hello World)

Everything You Need to Know About Electronics

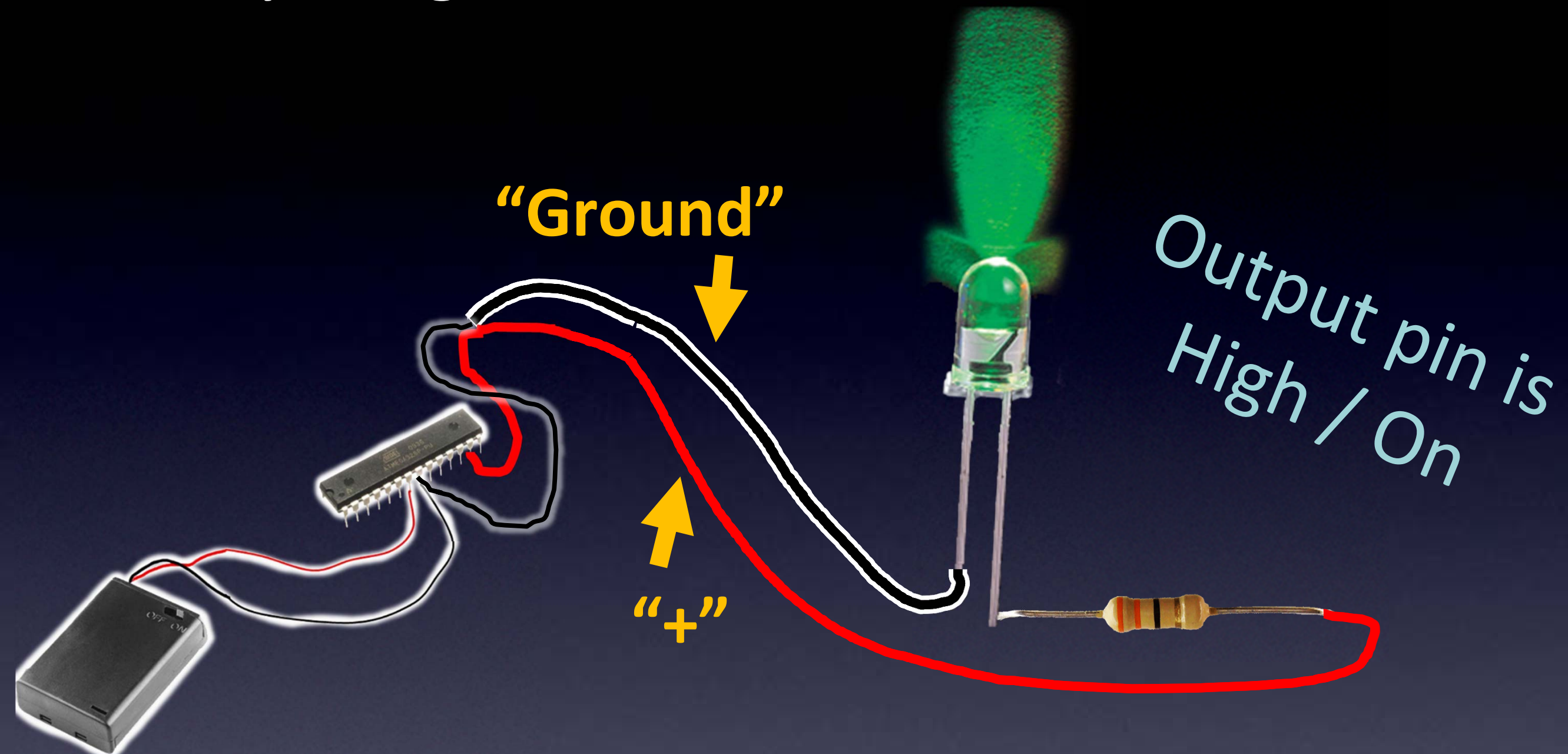

Turning an LED on and off

(Leading up to Hello World)

Everything You Need to Know About Electronics

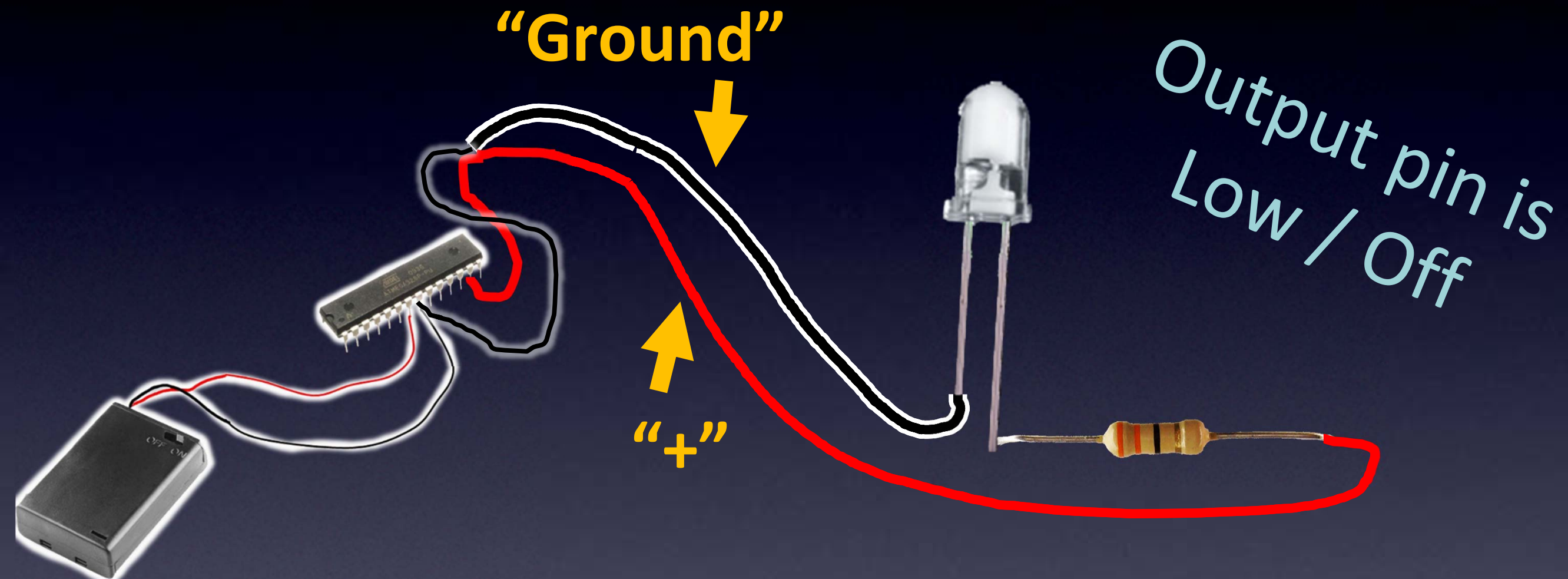

Turning an LED on and off

(Leading up to Hello World)

Everything You Need to Know About Electronics

This is our Hardware for Hello World!

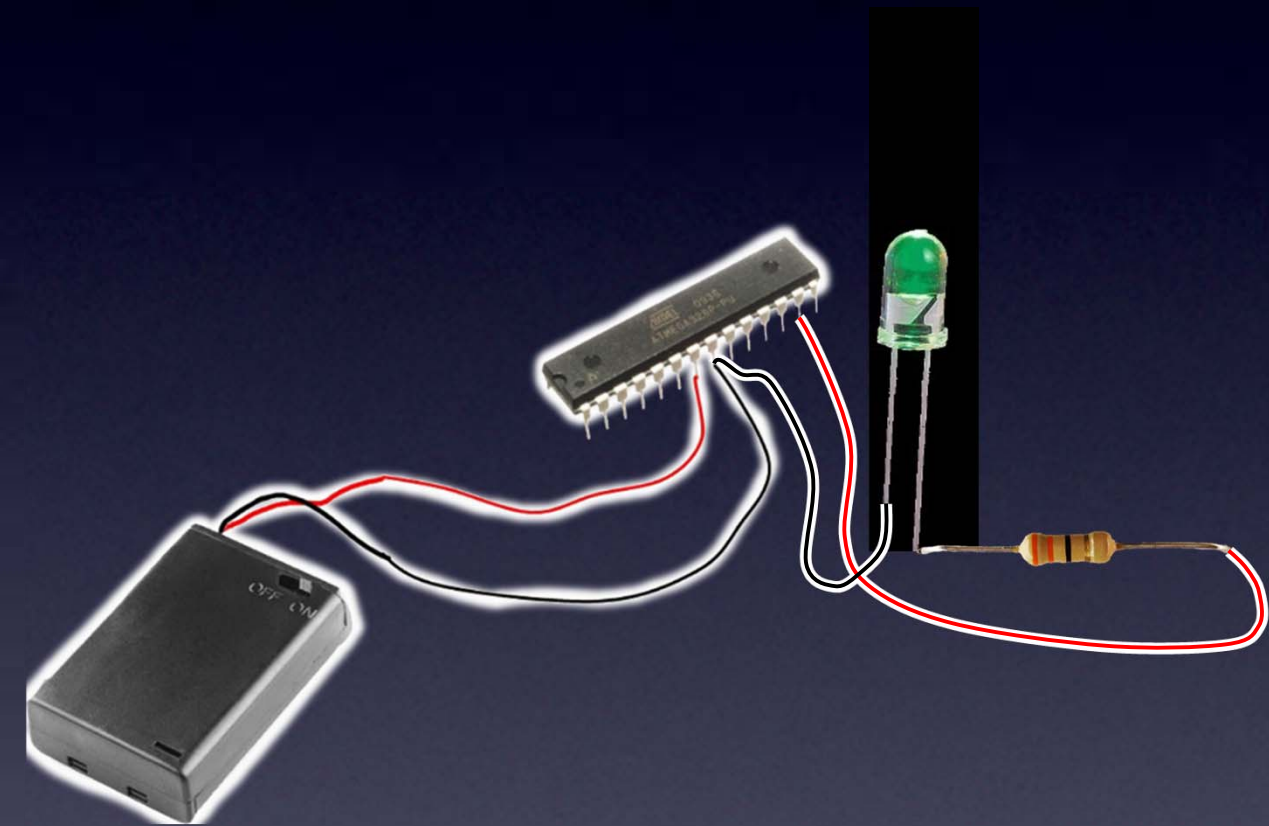

Turning an LED on and off

Hello World

Everything You Need to Know About Electronics

How about our program?

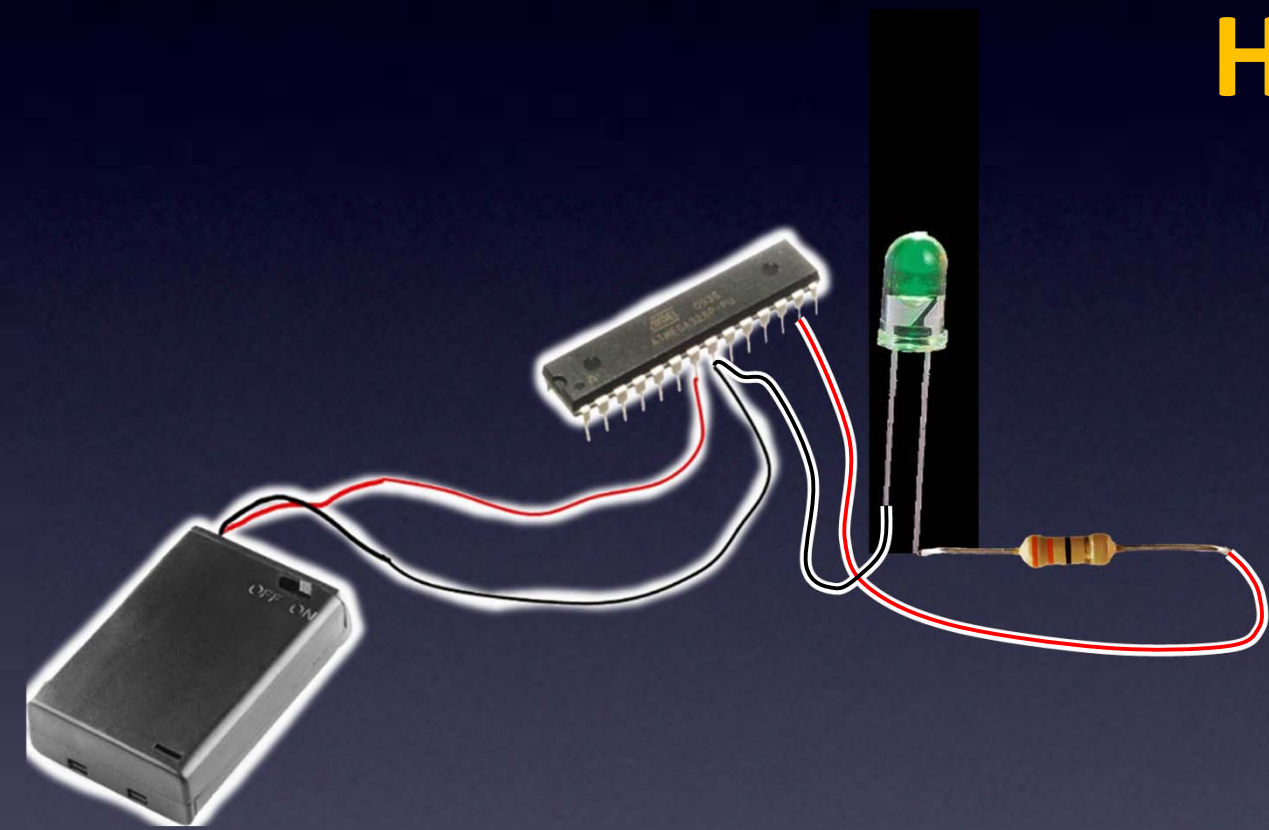

Turning an LED on and off

Hello World

Everything You Need to Know About Electronics

Programs on microcontrollers are called **“Firmware”**

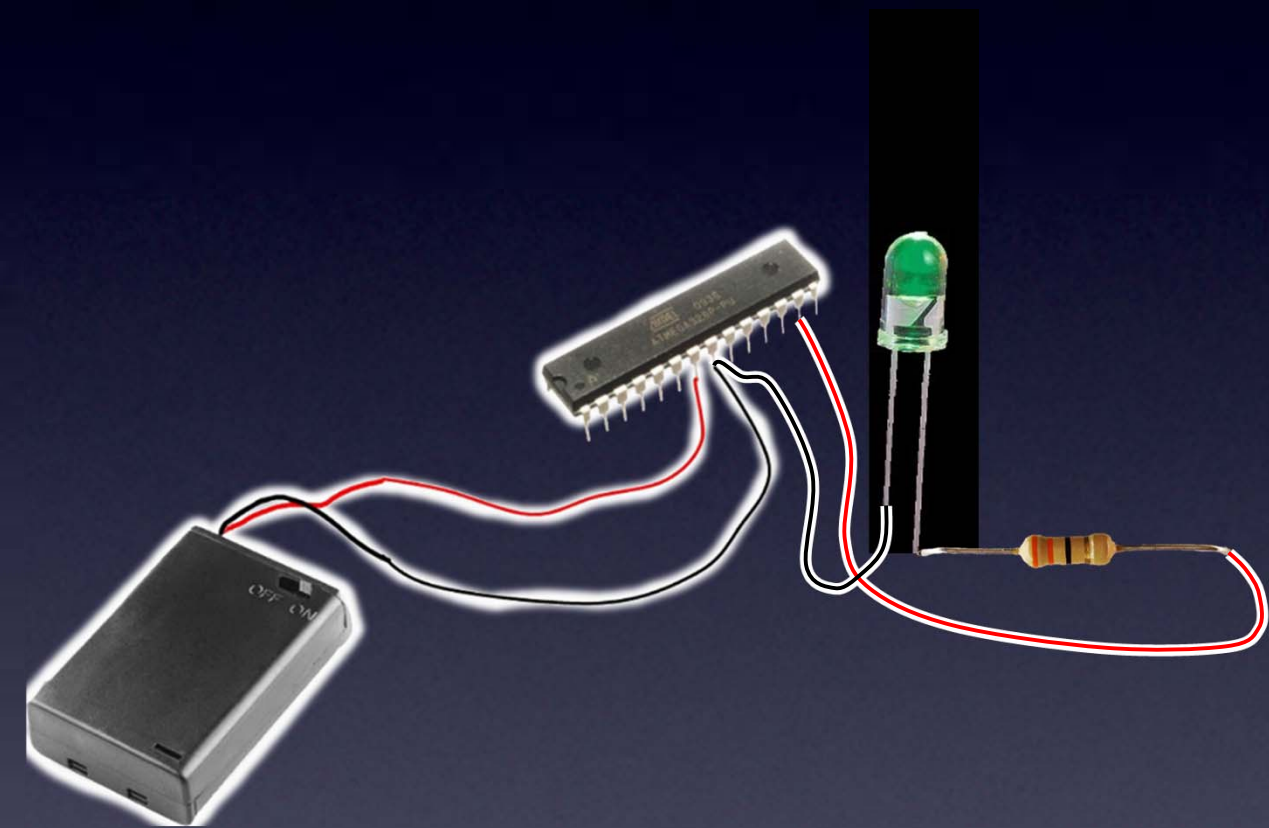

Turning an LED on and off

Hello World

Everything You Need to Know About Electronics

Programs on microcontrollers are called **“Firmware”**

A program for Arduino is called a
“Sketch”

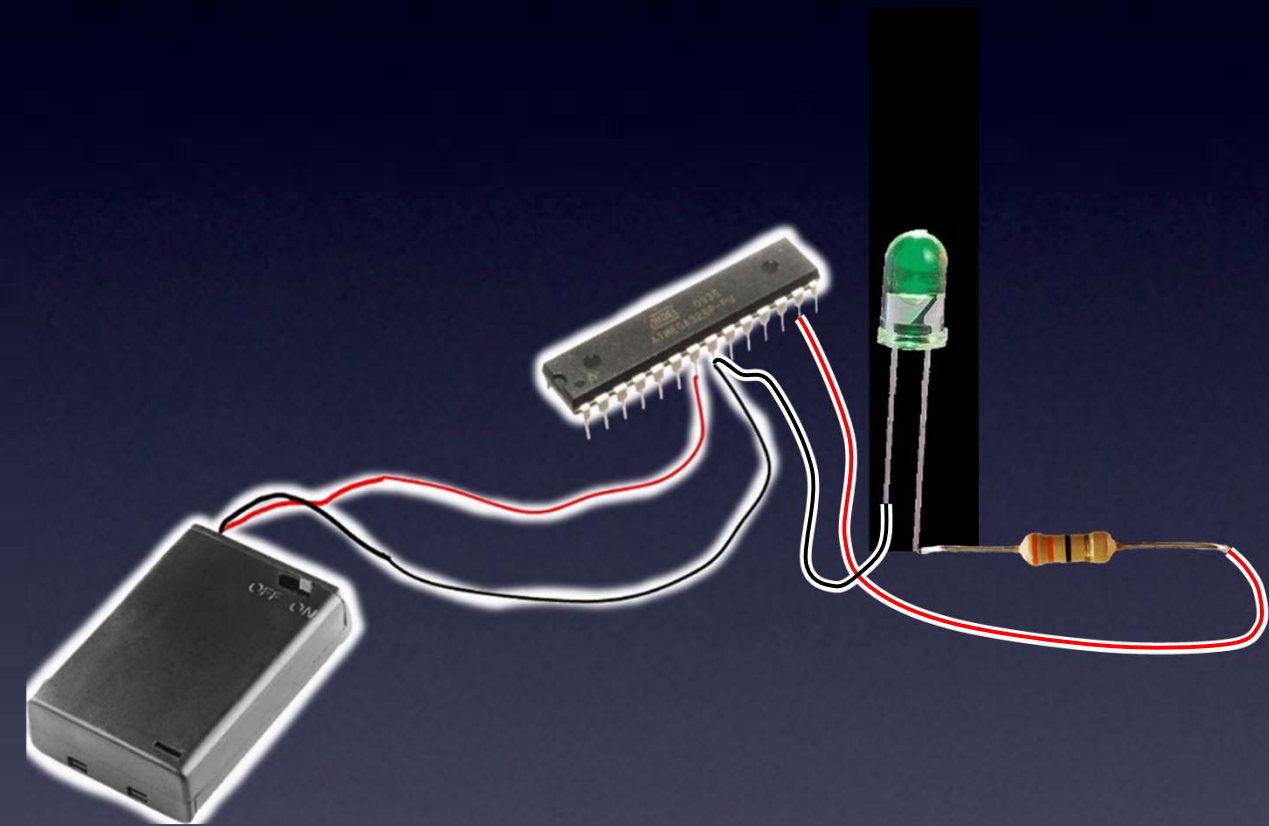

Turning an LED on and off

Hello World

Everything You Need to Know About Electronics

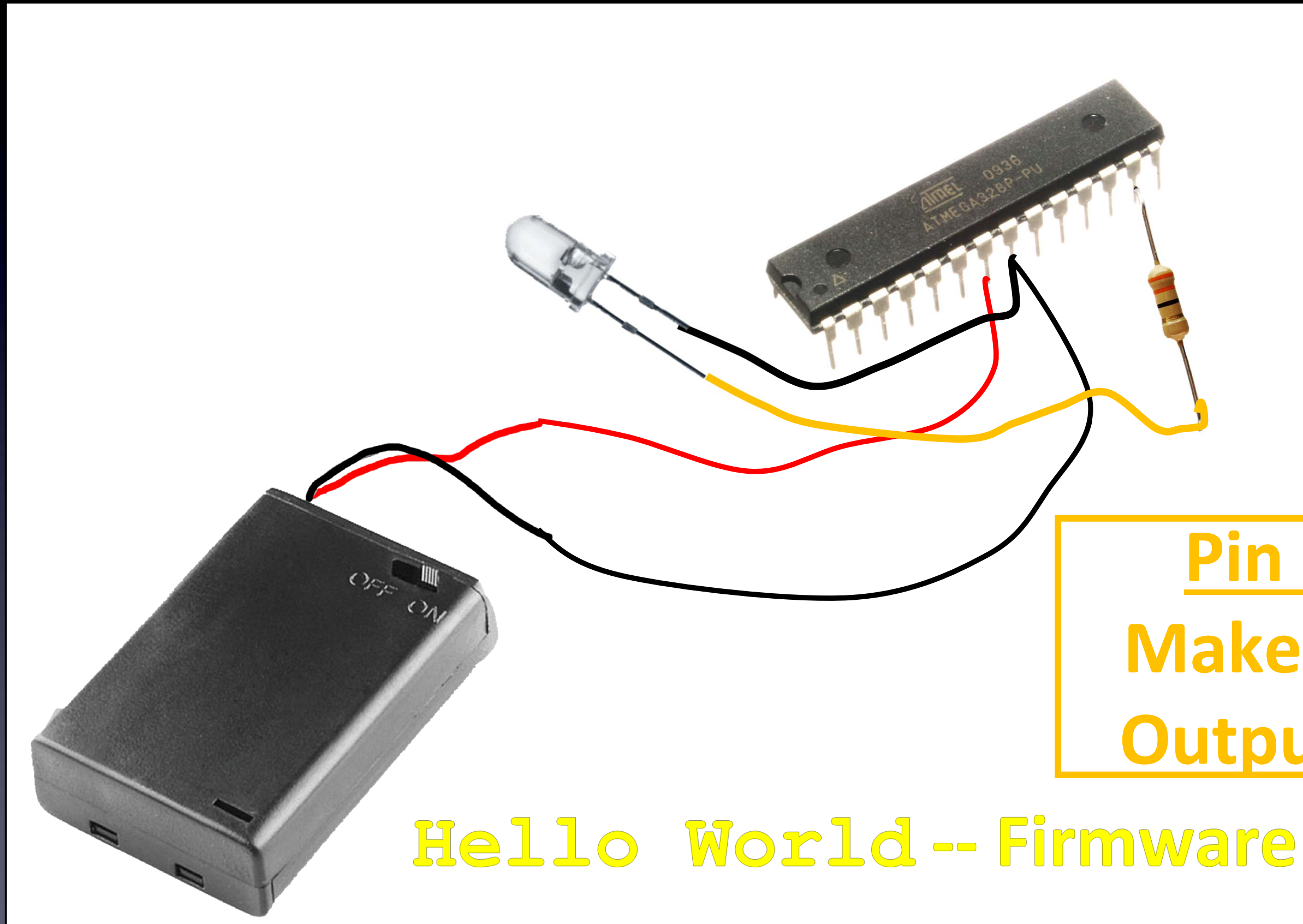

Pin 13:
Make it an
Output pin

Hello World -- Firmware

Microcontroller

Everything You Need to Know About Electronics

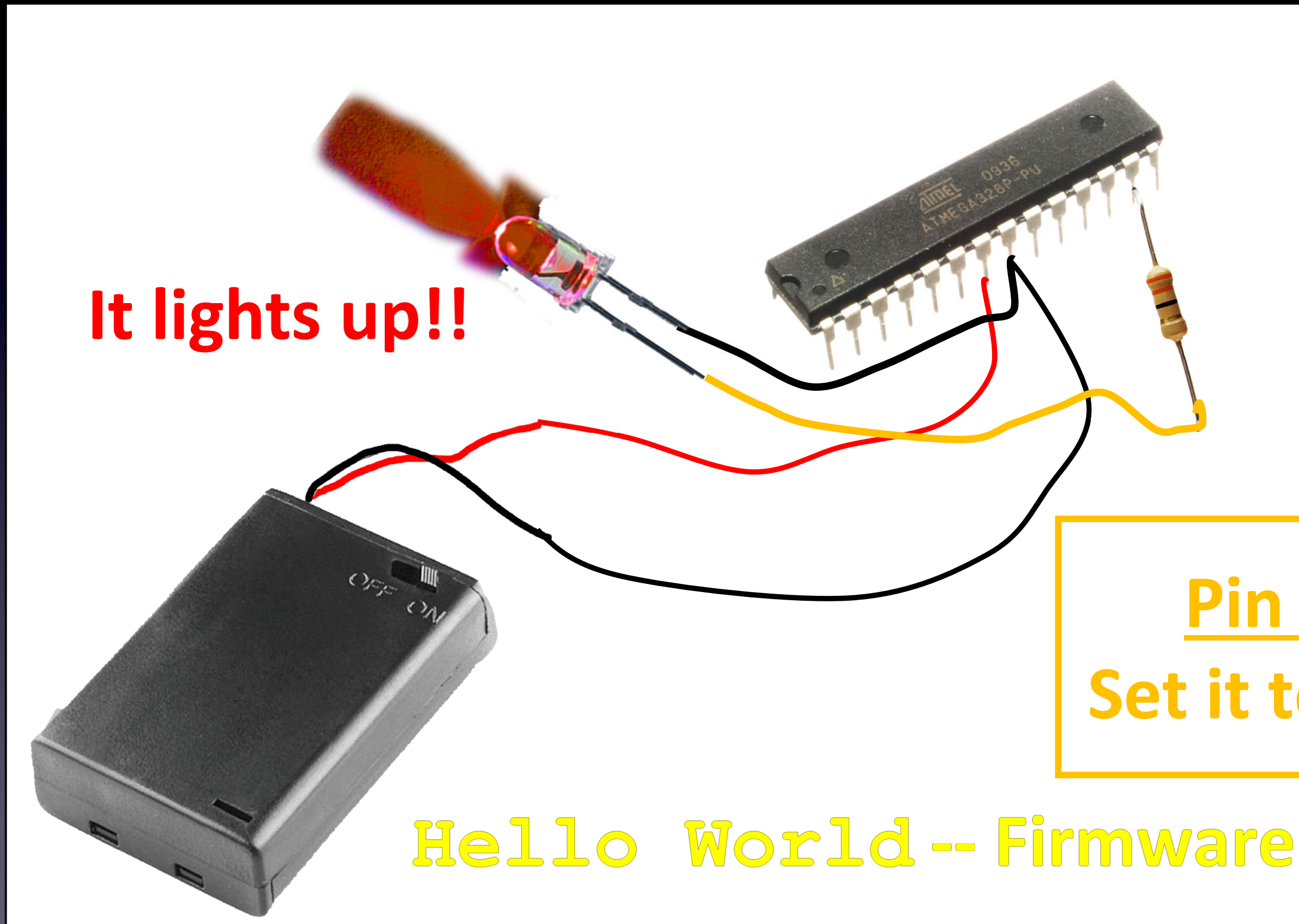

It lights up!!

**Pin 13:
Set it to High**

Hello World -- Firmware

Microcontroller

Everything You Need to Know About Electronics

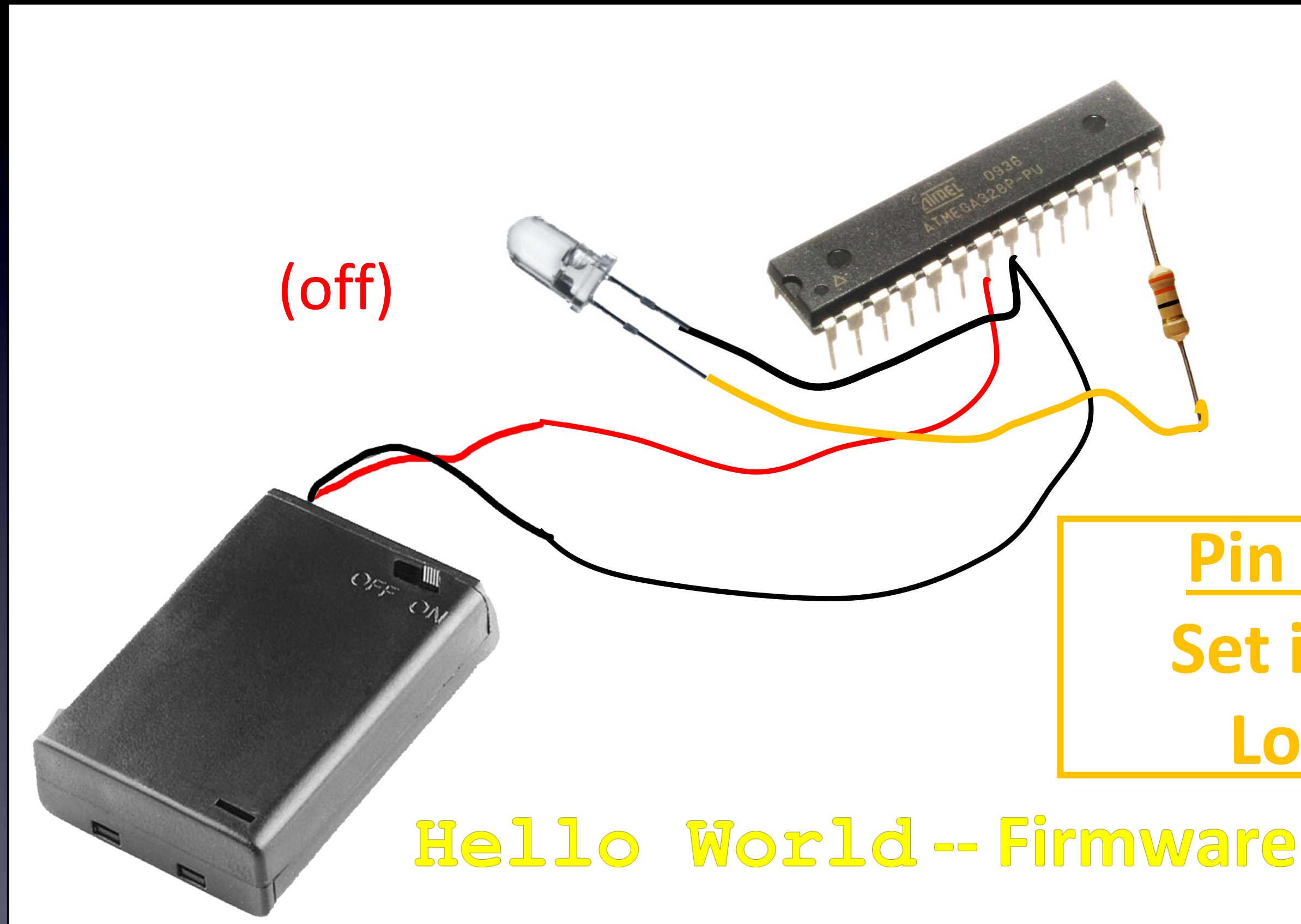

(off)

Pin 13:
Set it to
Low

Hello World -- Firmware

Microcontroller

Everything You Need to Know About Electronics



We now have
Hello World !

Microcontroller

Everything You Need to Know About Electronics

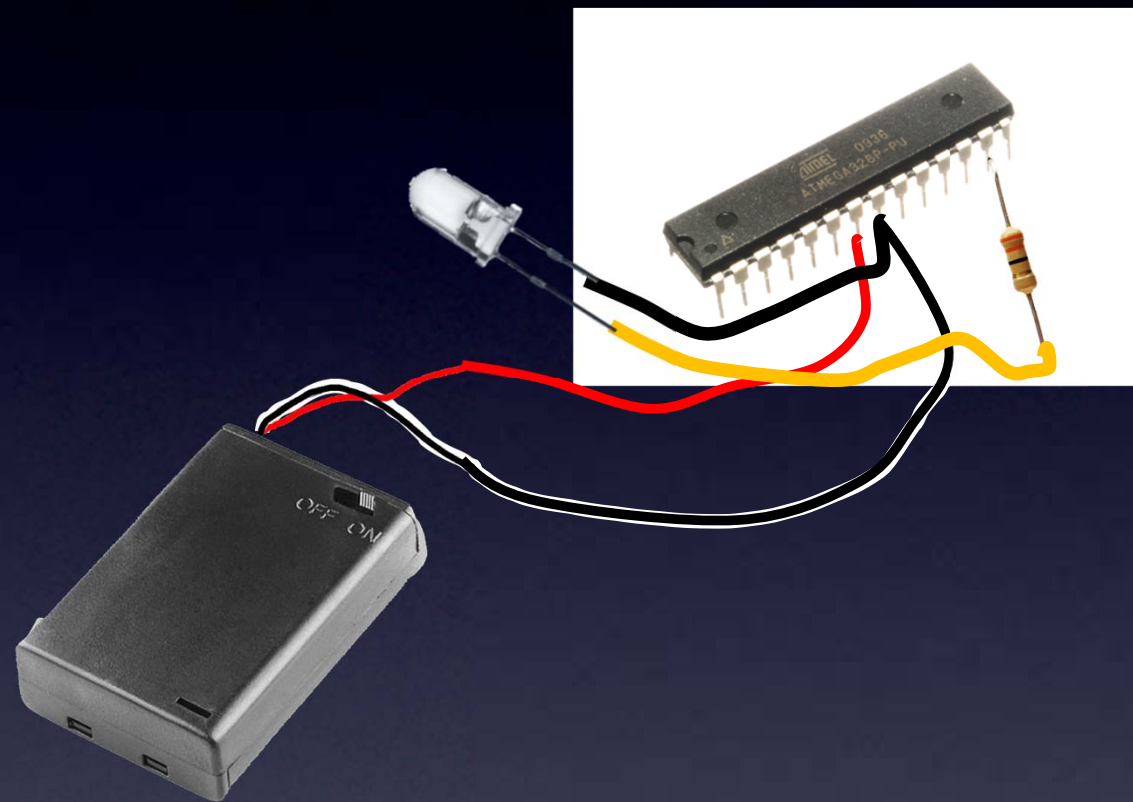

We now have
Hello World !

Except

We won't see it



Microcontroller

Everything You Need to Know About Electronics

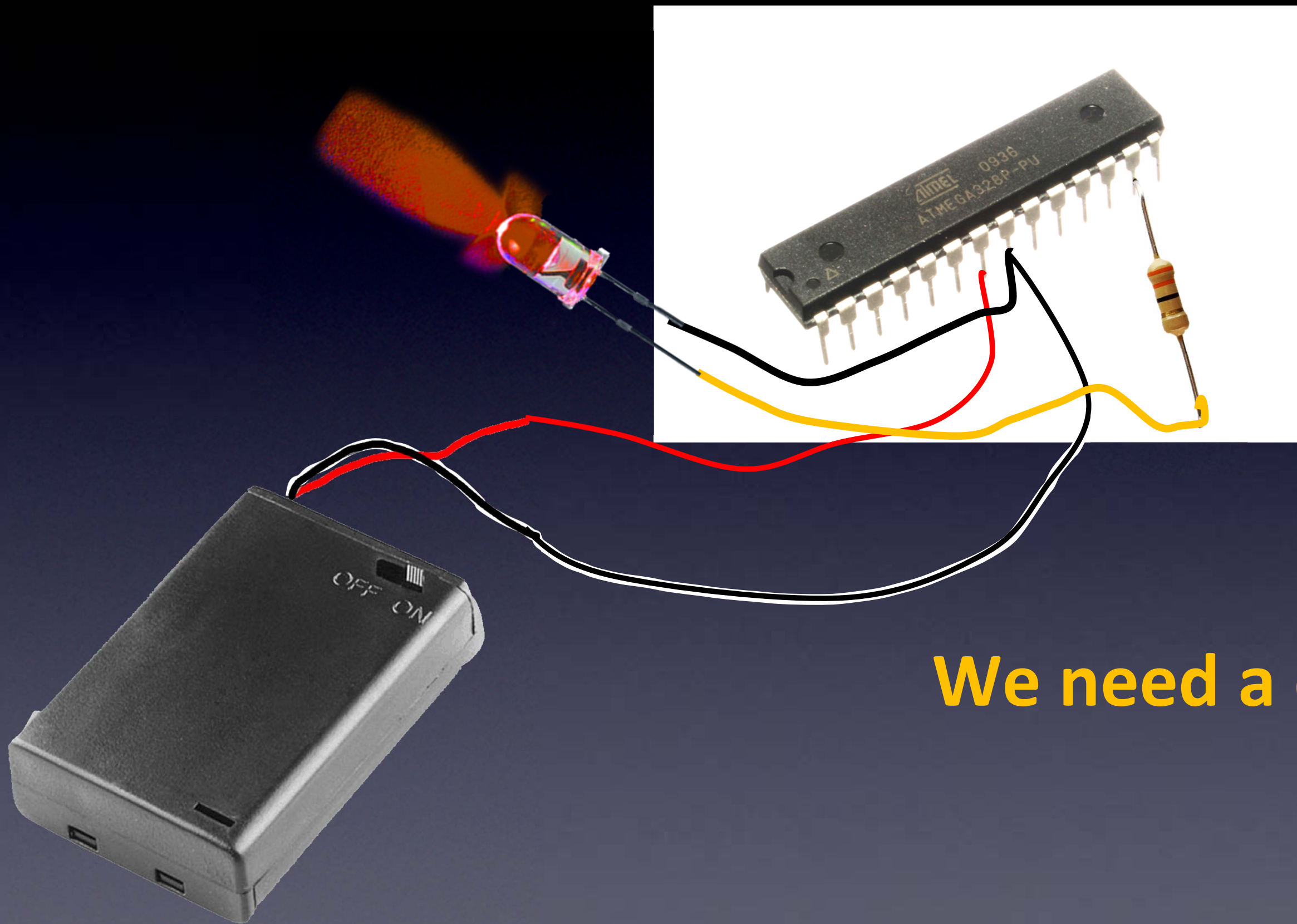

We need a delay

Microcontrollers – they go really fast!

Everything You Need to Know About Electronics

Hardware

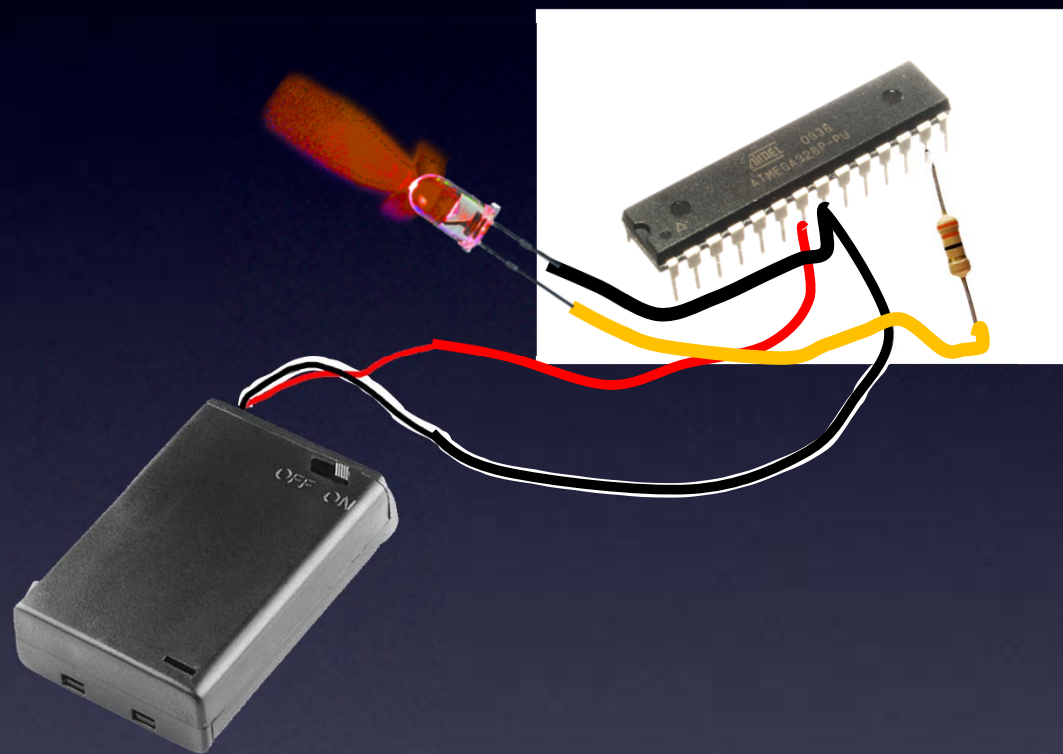

Firmware

- pin 13 is Output pin
- set pin 13 High
- delay
- set pin 13 Low

Hello World – for real now!

Microcontroller – Firmware

Everything You Need to Know About Electronics

Hardware

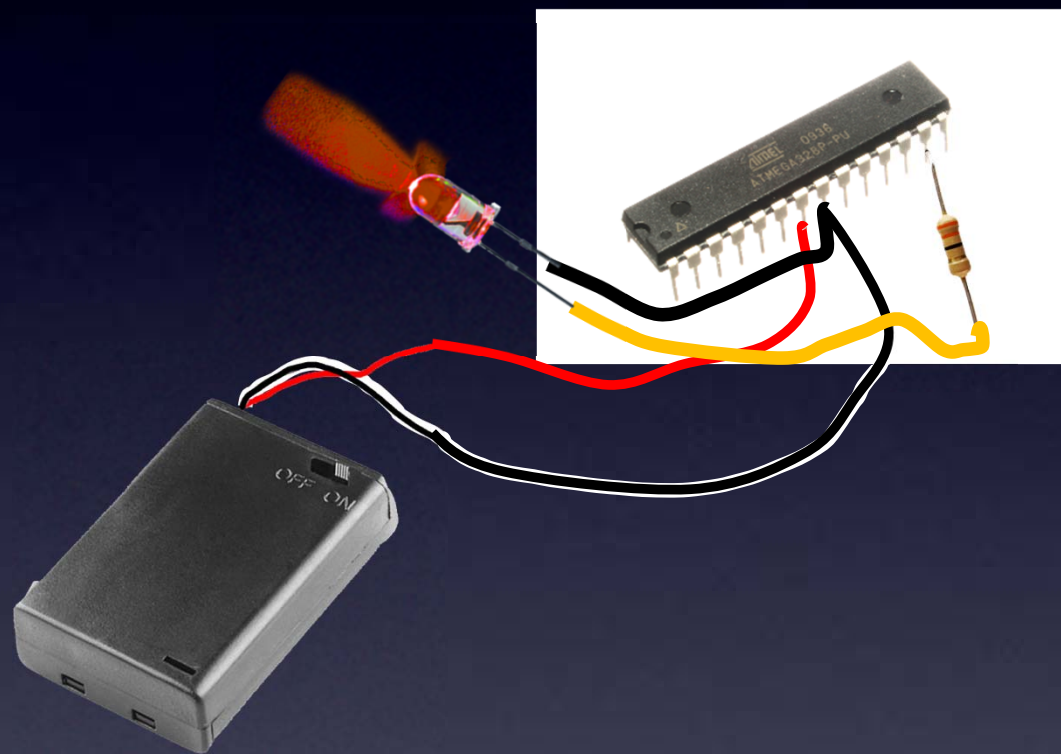

Firmware

- pin 13 is Output pin
- set pin 13 High
- delay
- set pin 13 Low
- delay

Hello World – for real now!

Microcontroller – Firmware

Everything You Need to Know About Electronics

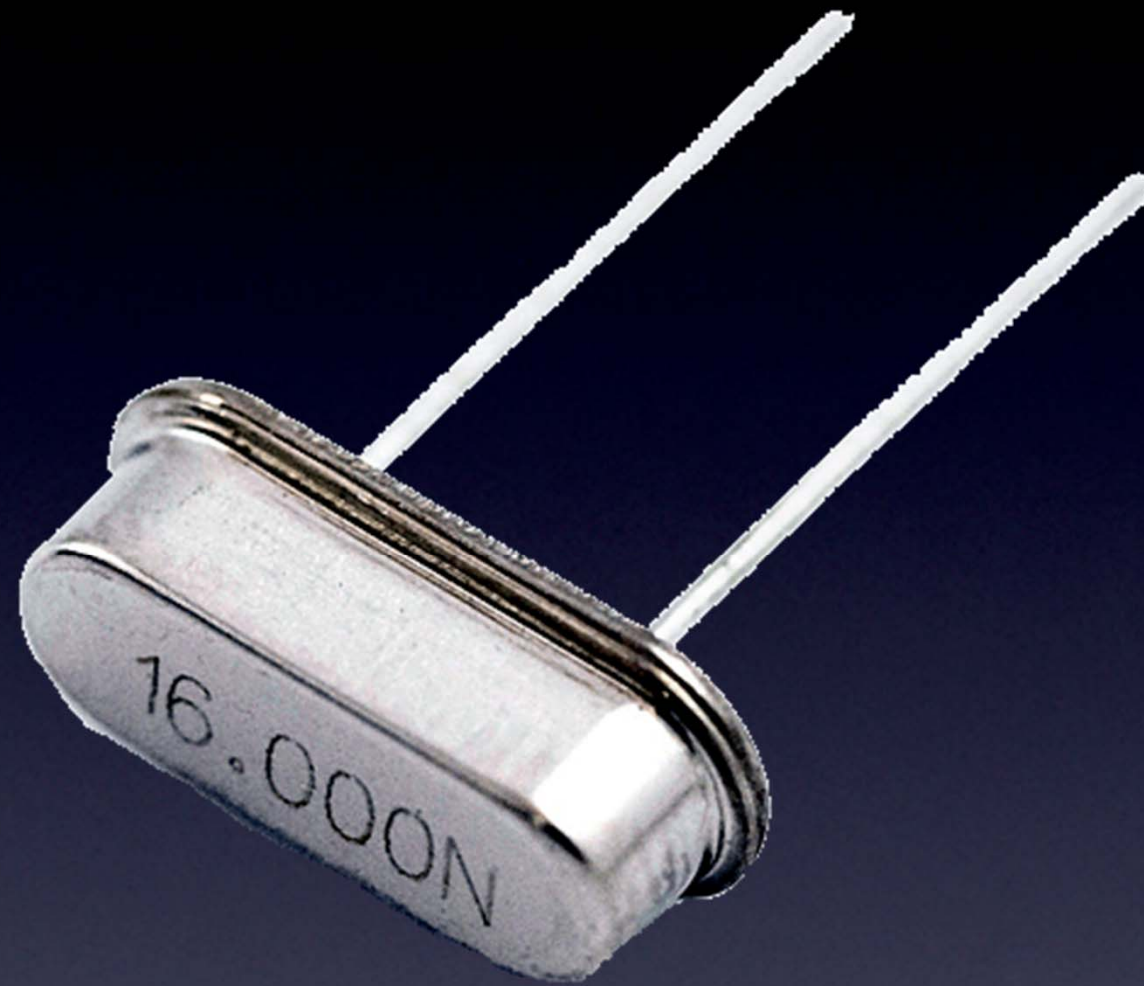

A precision cut piece of quartz crystal

For precise timing

Crystal / Hertz

Everything You Need to Know About Electronics



Frequency, measured in **Hertz**

For precise timing (but less than a crystal)

Crystal / **Hertz**

Everything You Need to Know About Electronics

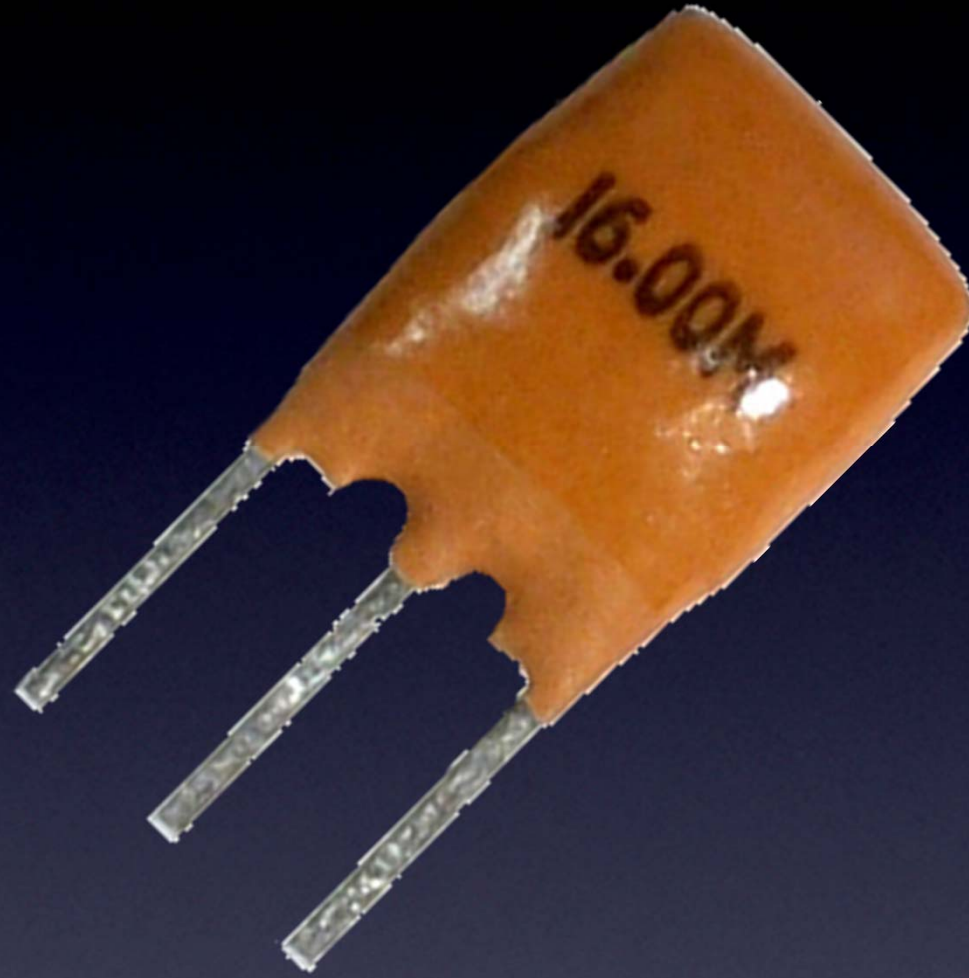

A bunch of resistors and capacitors

For precise timing (but less than a crystal)

Ceramic Resonator / Hertz

Everything You Need to Know About Electronics

Hardware

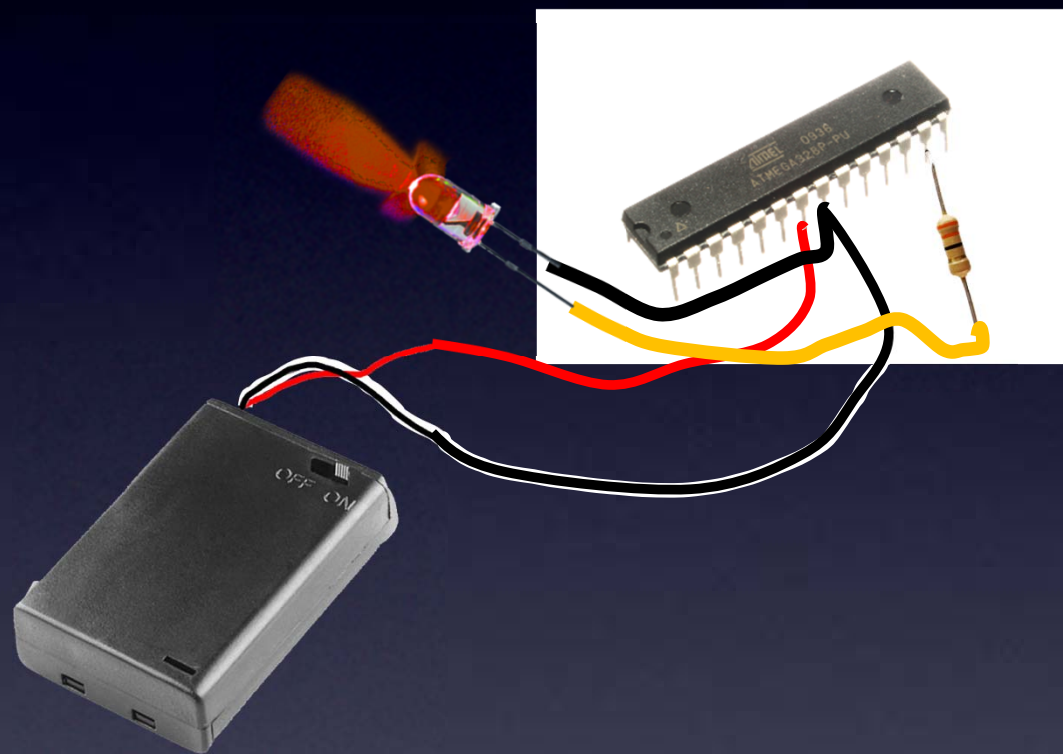

Firmware

- pin 13 is Output pin
- set pin 13 High
- delay
- set pin 13 Low

Let's hack Hello World!

Microcontroller

Everything You Need to Know About Electronics

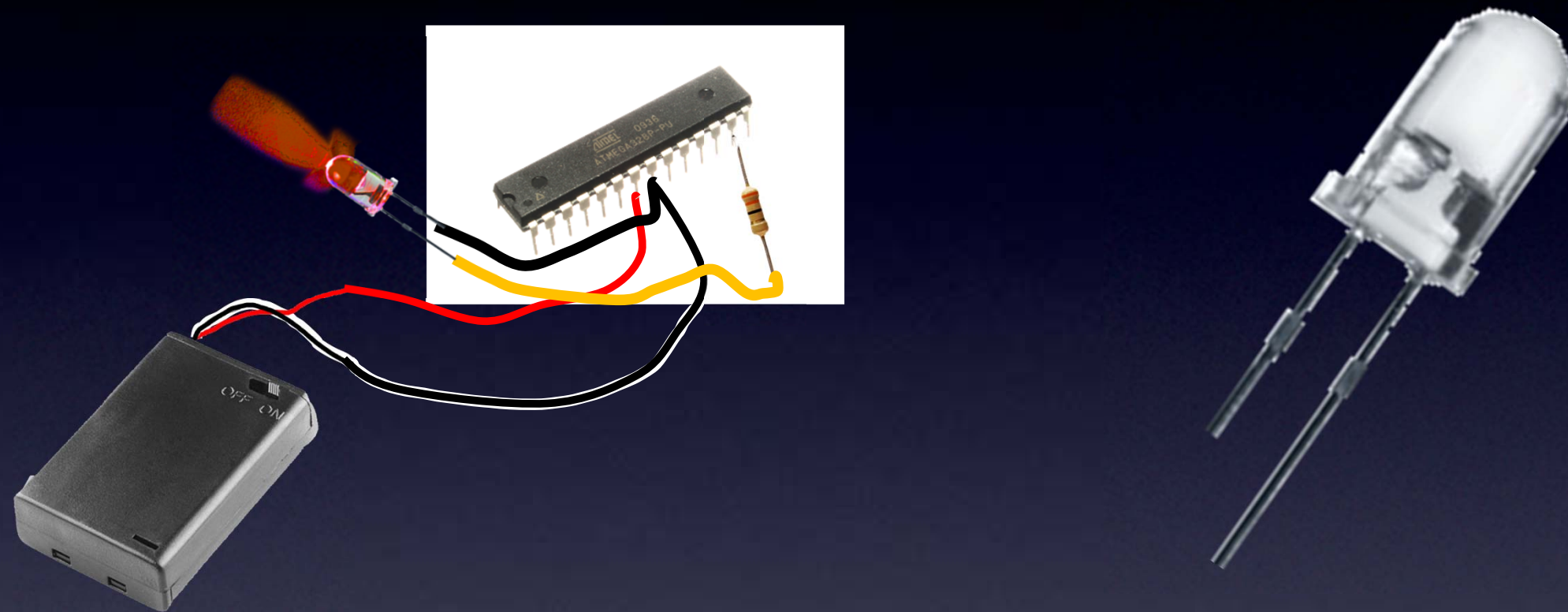

Add an IR LED to another pin

IR "OFF" codes

Microcontroller

Everything You Need to Know About Electronics

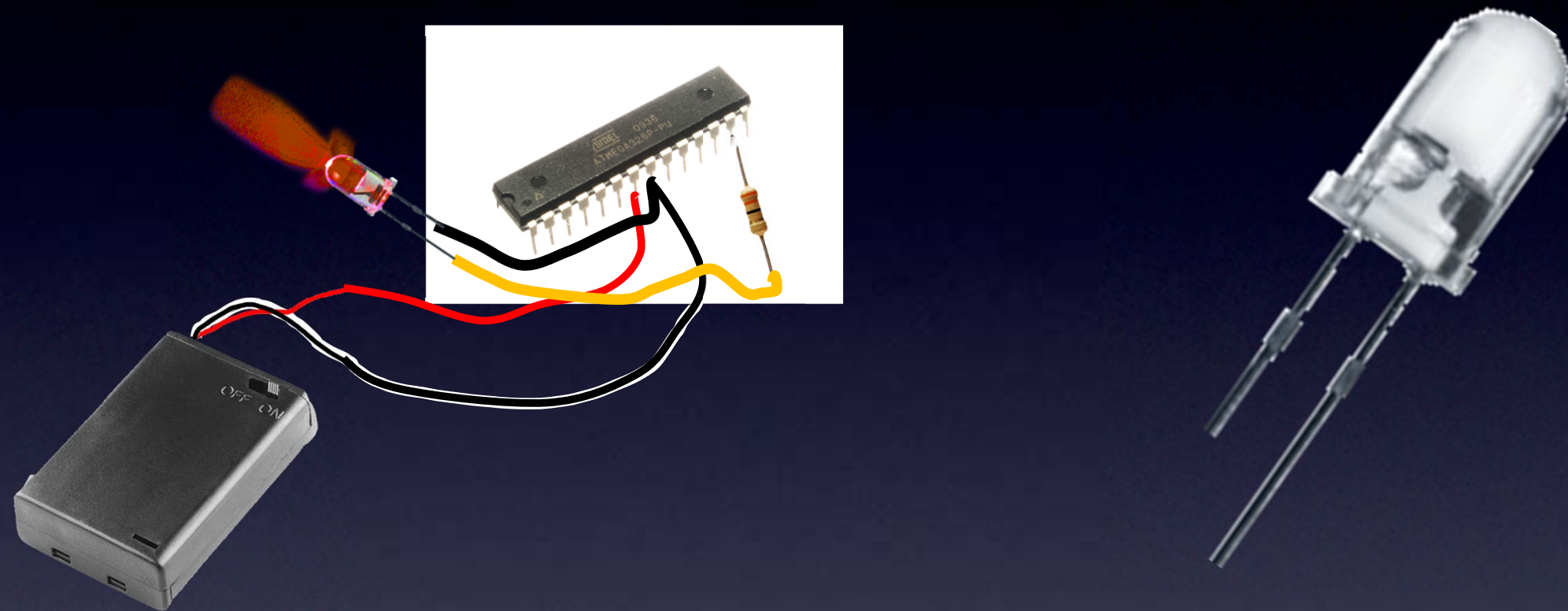

Add an IR LED to another pin (say, pin3)

IR "OFF" codes

Microcontroller

Everything You Need to Know About Electronics

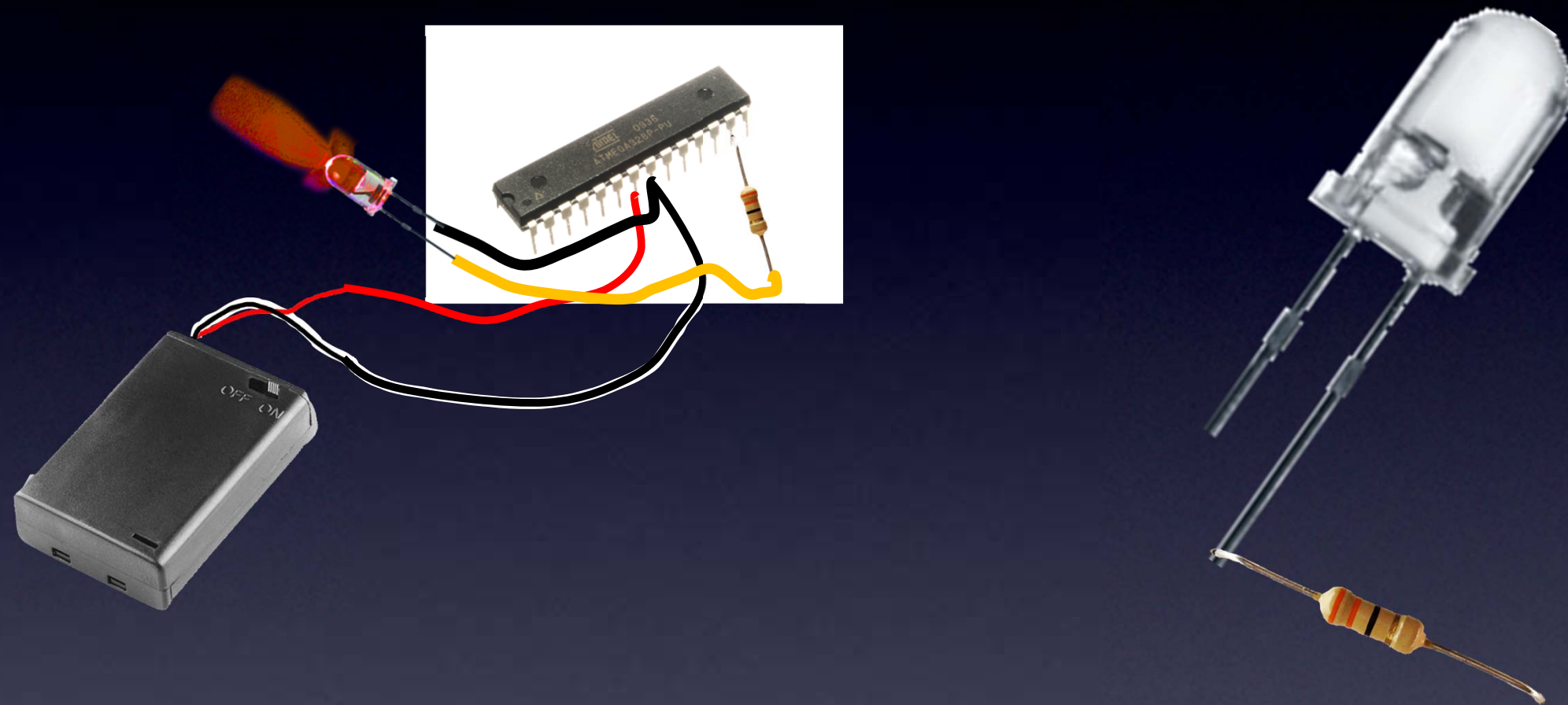

Add an IR LED to another pin (say, pin3)
and a resistor so no magic smoke goes away

IR "OFF" codes

Microcontroller

Everything You Need to Know About Electronics

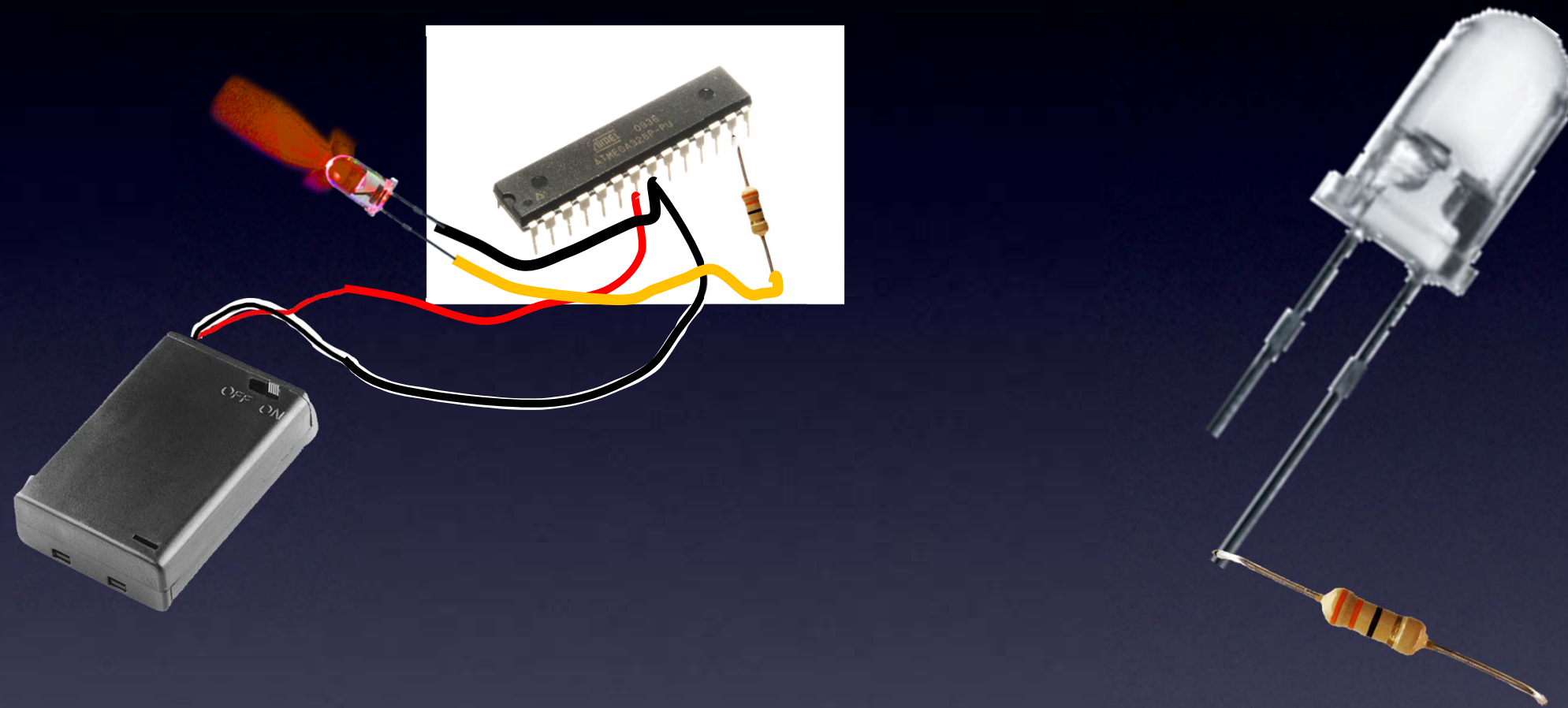

But, *When?*

IR "OFF" codes

Microcontroller

Everything You Need to Know About Electronics

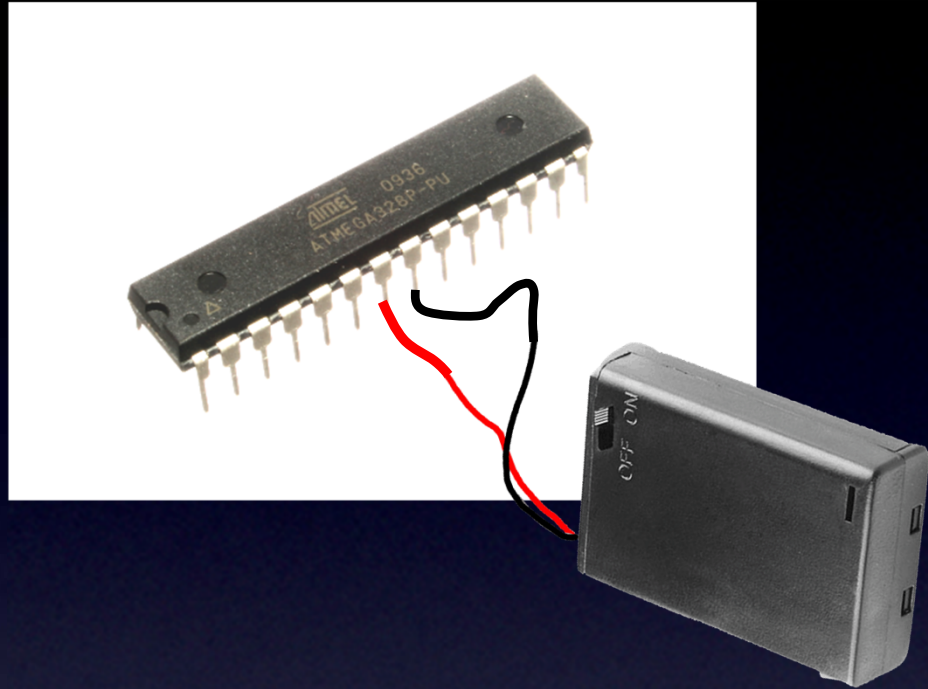

Let's add an Input pin!

and

We can add a Start button

Microcontroller

Everything You Need to Know About Electronics

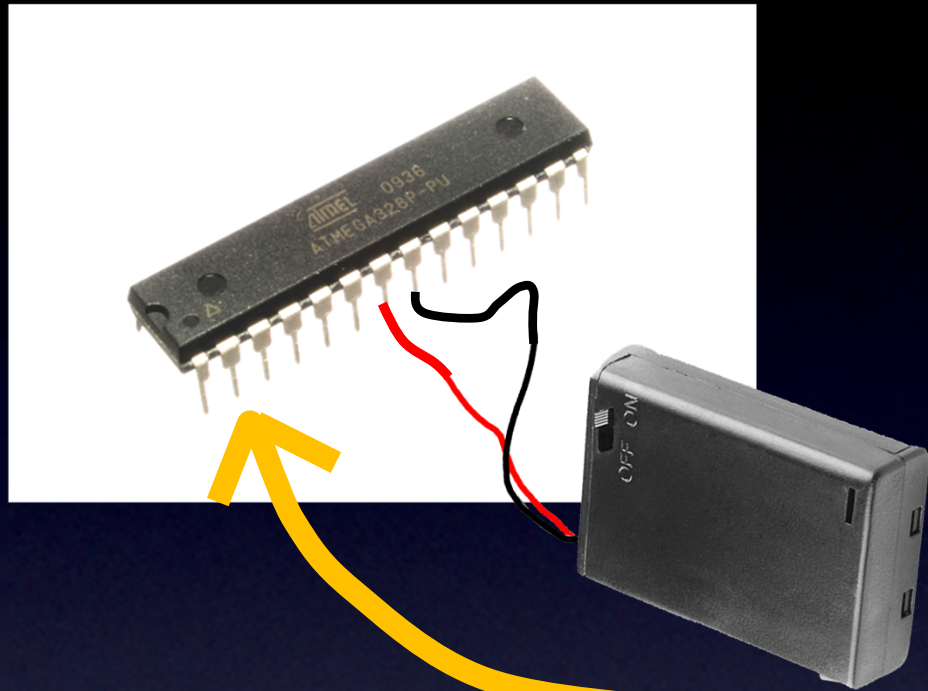

How do we make a pin an Input pin?

We tell it to be one – with our program.

Any pin can be an Input pin (like, pin 2).

Microcontroller – Input pins

Everything You Need to Know About Electronics

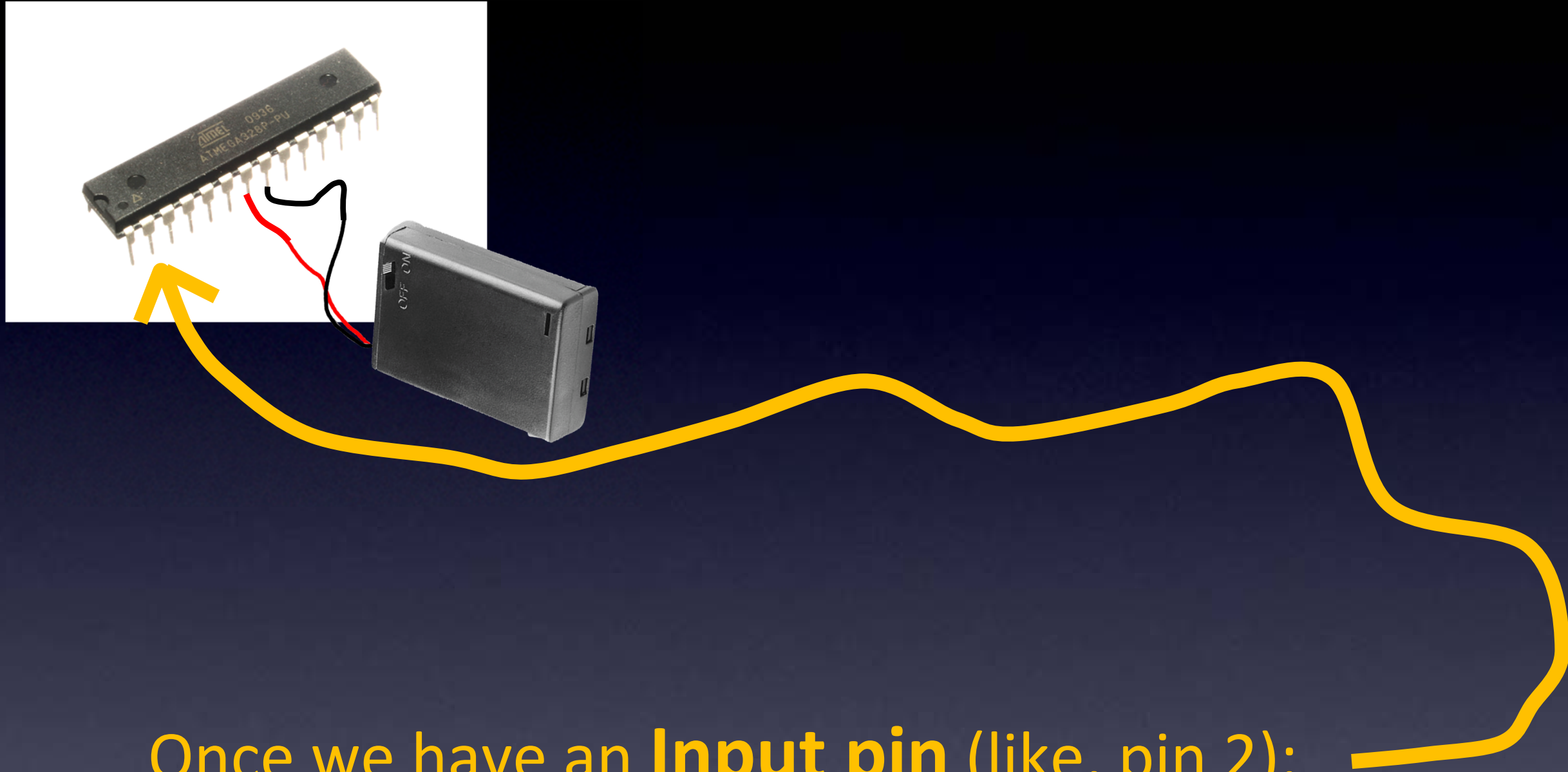

Once we have an **Input pin** (like, pin 2):

only 2 choices – is the Input pin: **High** or **Low** ?

Microcontroller – Input pins

Everything You Need to Know About Electronics

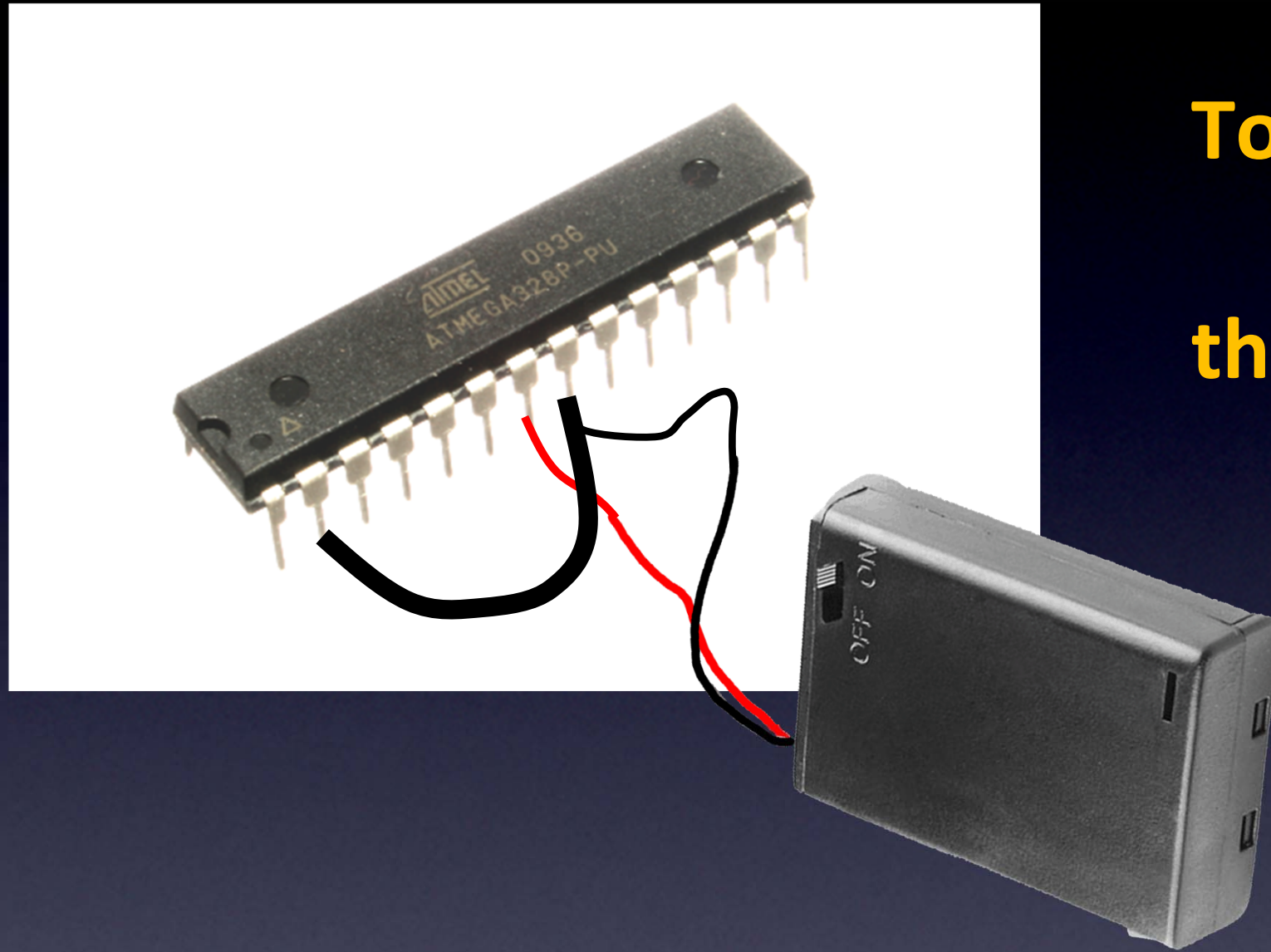

To make the Input pin **Low**, connect it to the **Black** wire of our power supply (**Ground**).

Low

Microcontroller – Input pins

Everything You Need to Know About Electronics

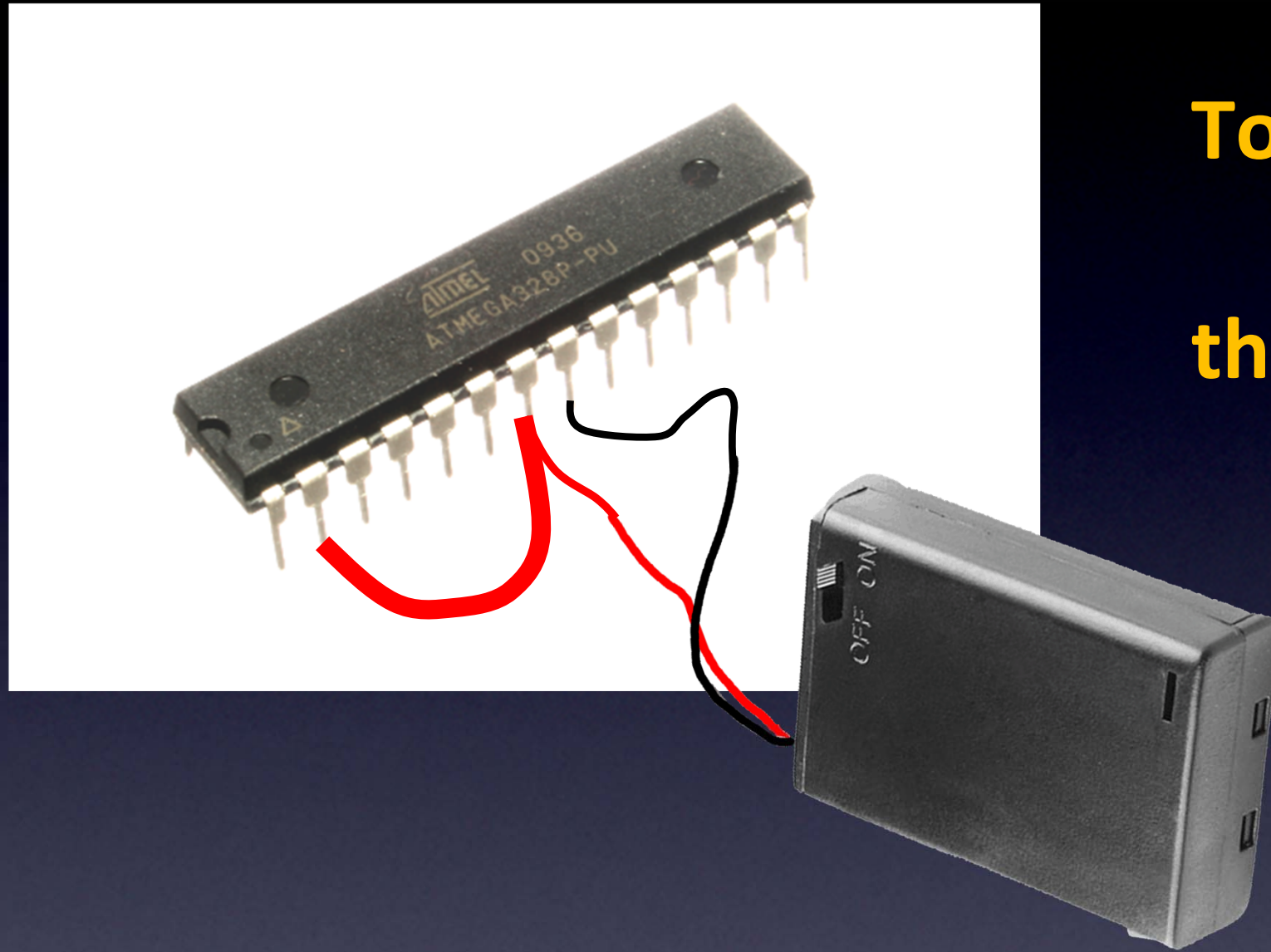

To make the Input pin High, connect it to the Red wire of our power supply (Vcc).

High

Microcontroller – Input pins

Everything You Need to Know About Electronics

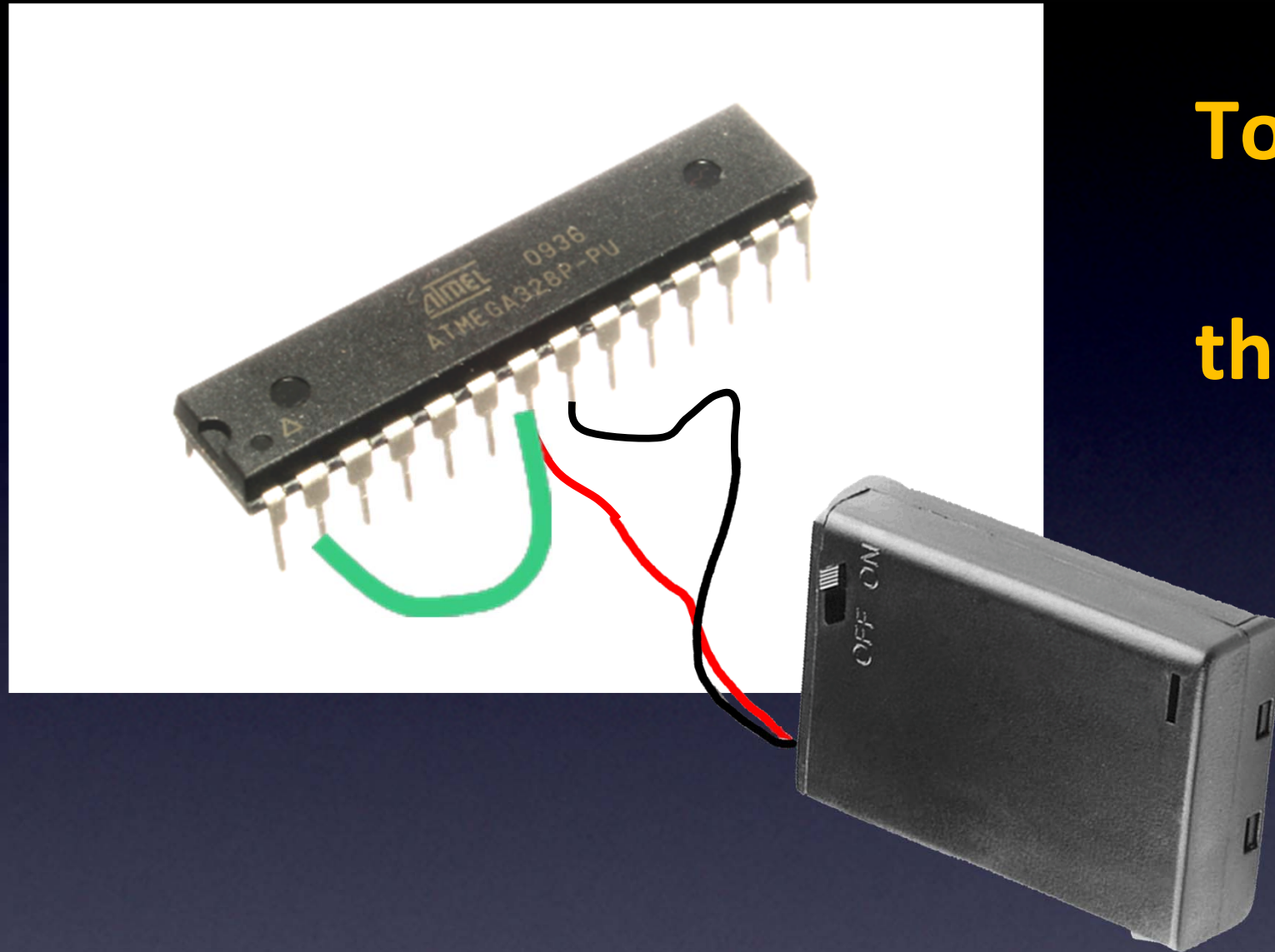

To make the Input pin High,
connect it to
the Red wire of our power
supply (Vcc).

FYI:

Wire color does **not** matter !

(electrons don't care)

High

Microcontroller – Input pins

Everything You Need to Know About Electronics

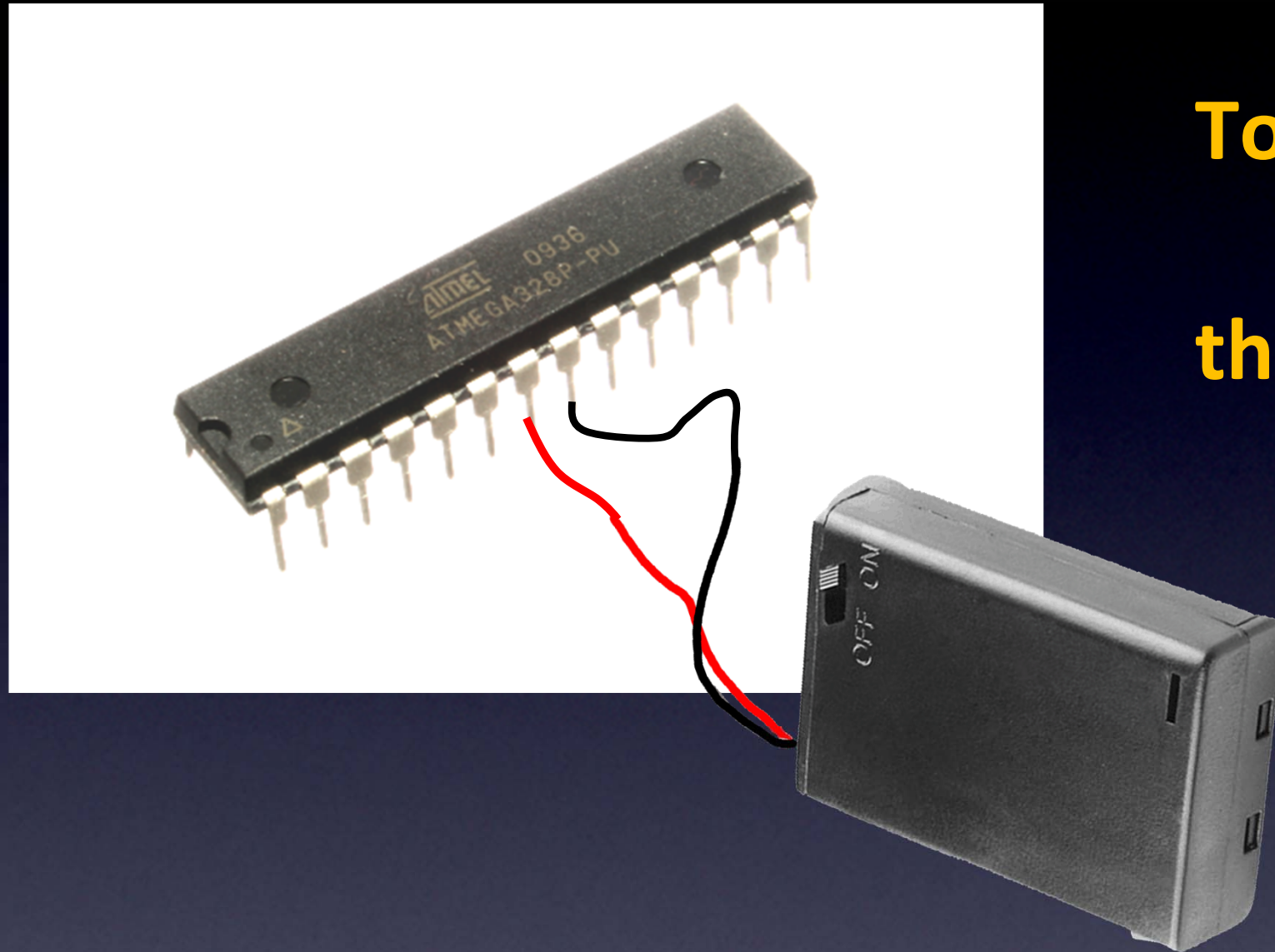

**To make the Input pin High,
connect it to
the Red wire of our power
supply (Vcc).**

OR:

just leave it blank
(built-in resistors on each Input pin)

High

Microcontroller – Input pins

Everything You Need to Know About Electronics

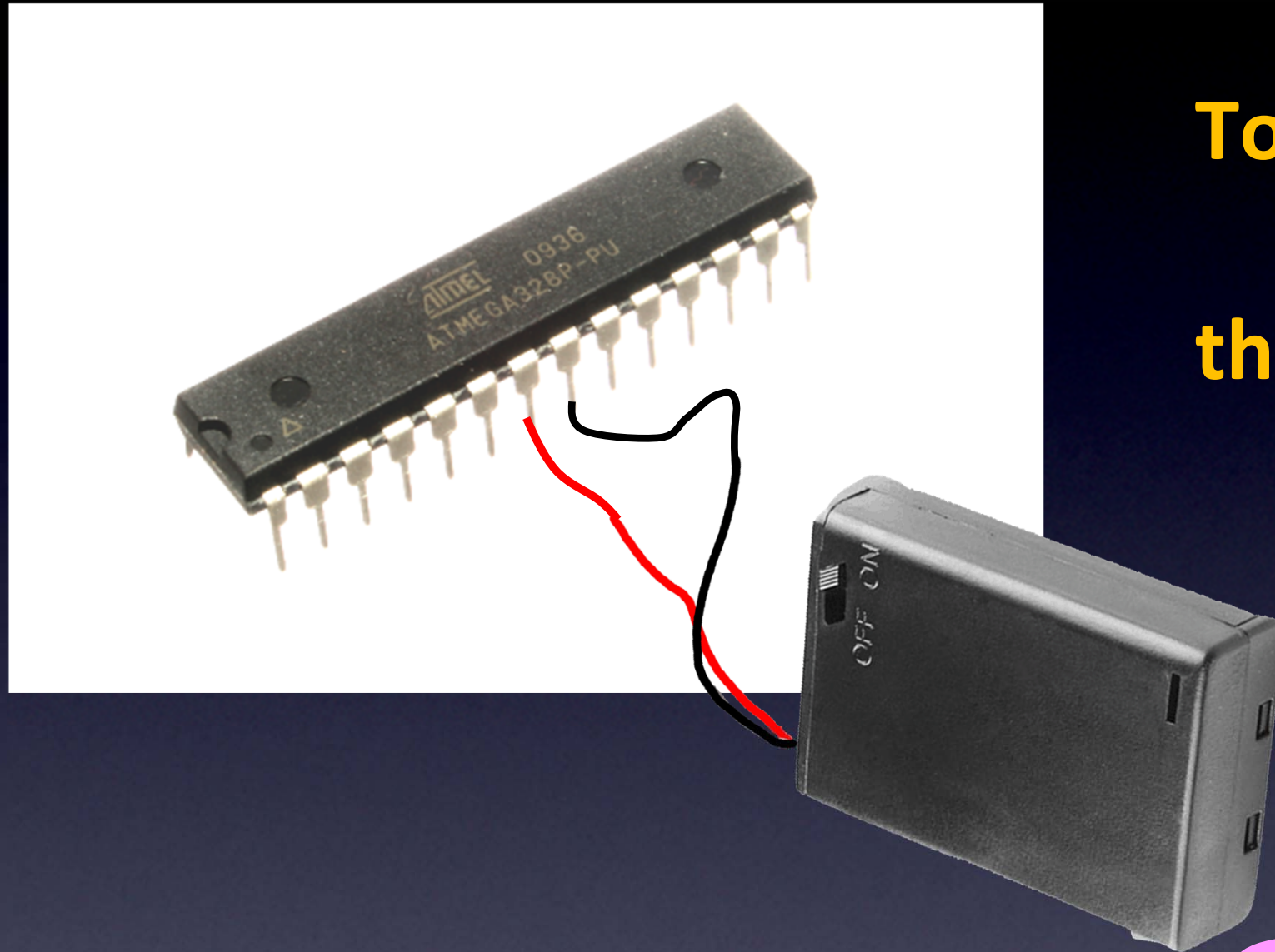

To make the Input pin High, connect it to the Red wire of our power supply (Vcc).

OR:

just leave it blank

(built-in resistors on each Input pin)

High

"Pull-up" Resistors

are built-in

to the microcontroller's

Input pins



Microcontroller – Input pins

Everything You Need to Know About Electronics

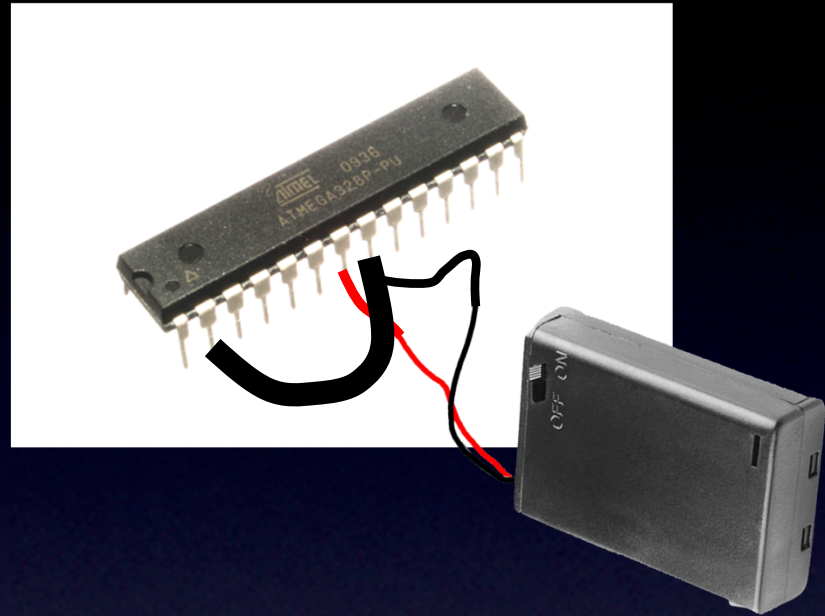

If firmware looks at
Pin 2 when it's like this,
it reports back:

Low

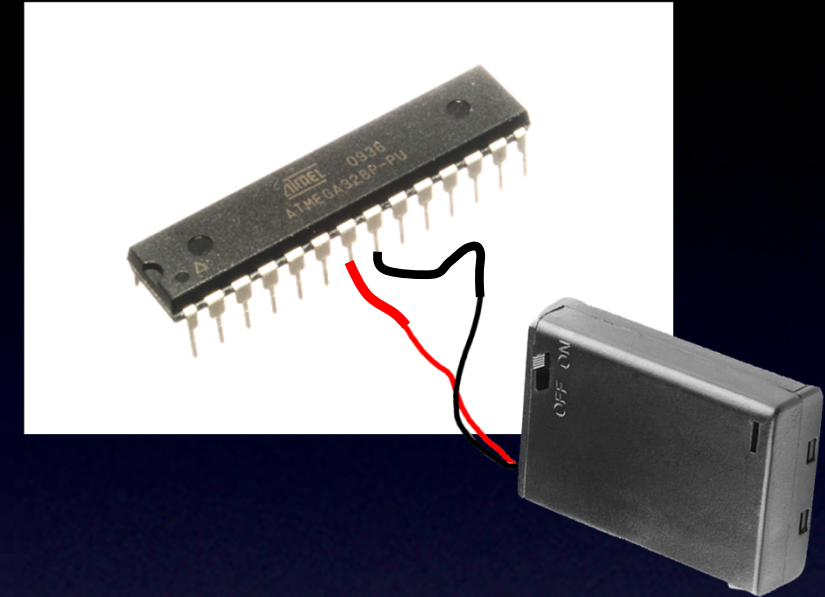

If firmware looks at
Pin 2 when it's like this,
it reports back:

High

Reading the Input pin

Microcontroller – Input pins

Everything You Need to Know About Electronics

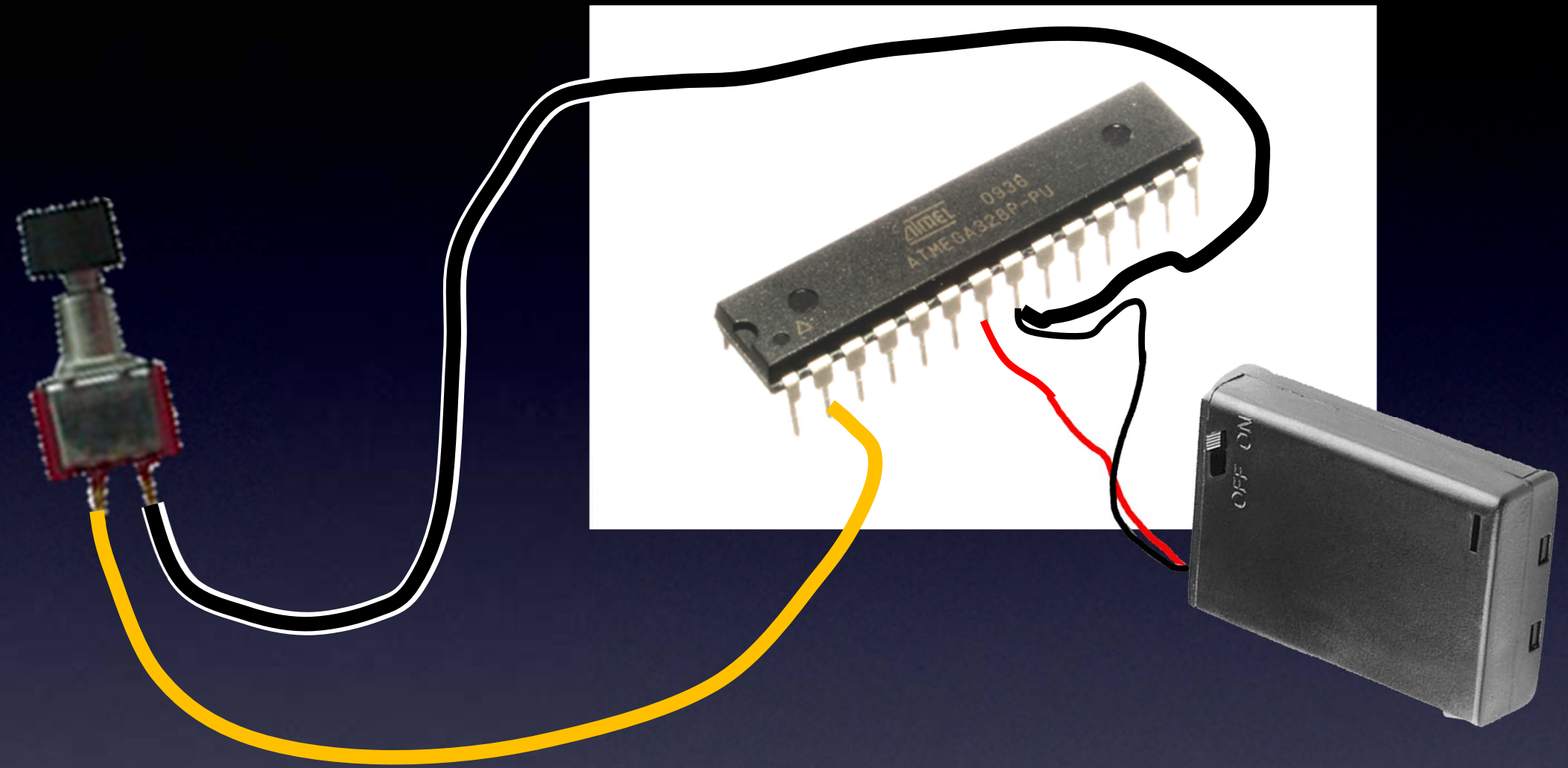

Reading the Input pin, with Switch

Microcontroller – Input pins

Everything You Need to Know About Electronics

If firmware
looks at Pin 2
when switch
NOT pushed,
it reports back:
High

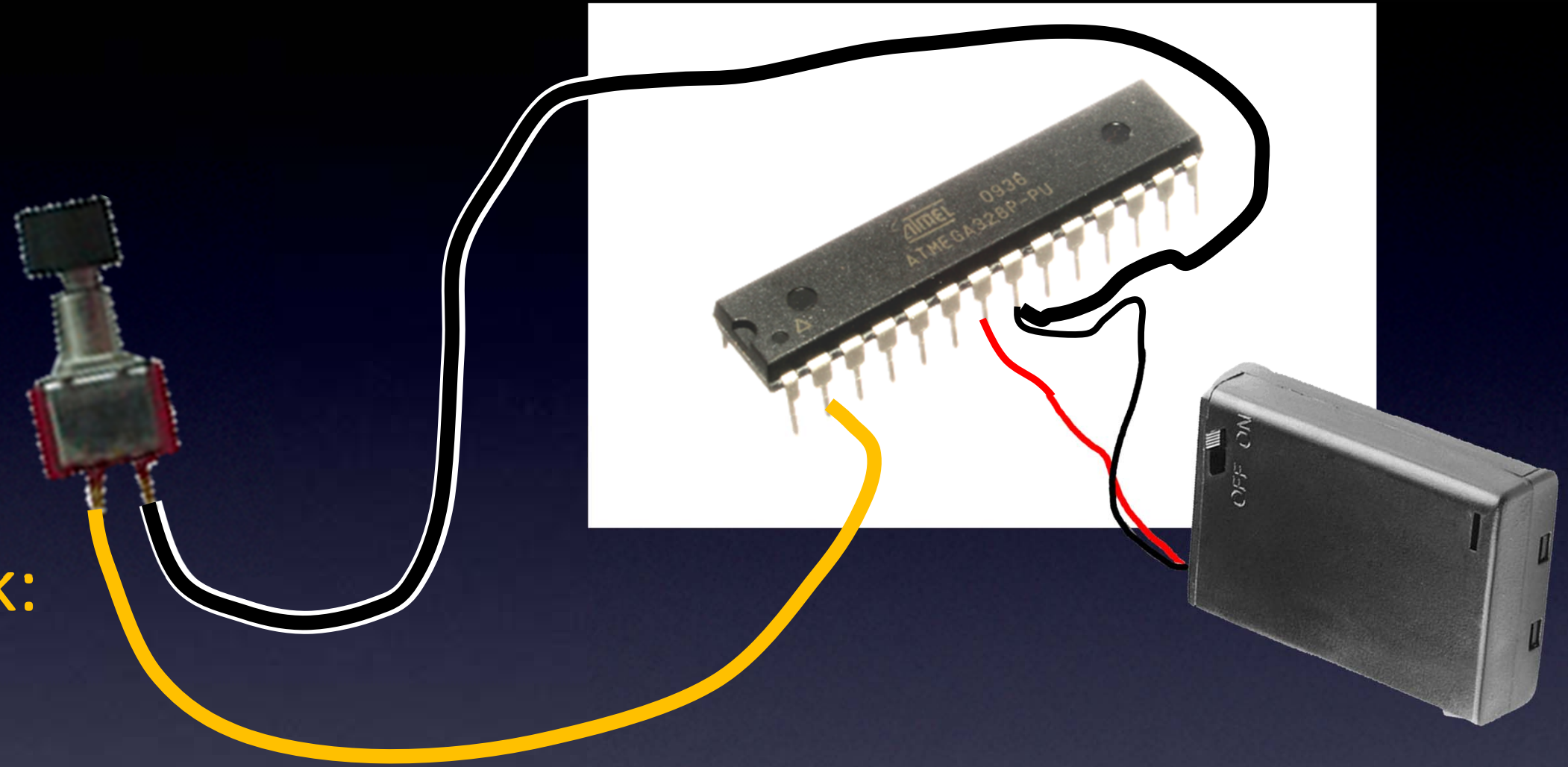

Reading the Input pin, with Switch

Microcontroller – Input pins

Everything You Need to Know About Electronics

If firmware looks at Pin 2 when switch pushed,
it reports back:
Low

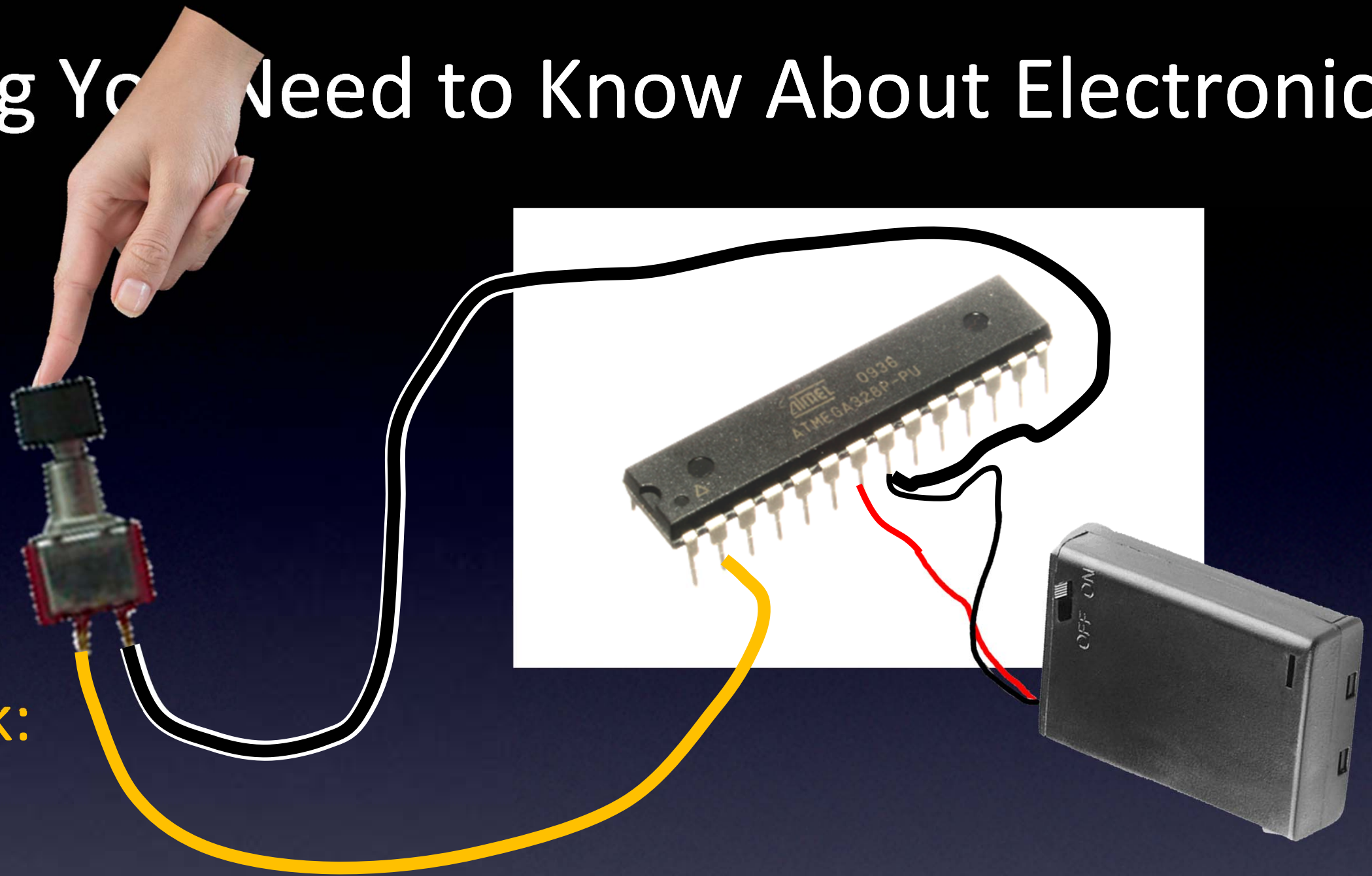

Reading the Input pin, with Switch

Microcontroller – Input pins

Everything You Need to Know About Electronics

If firmware
looks at Pin 2
when switch
NOT pushed,
it reports back:
High

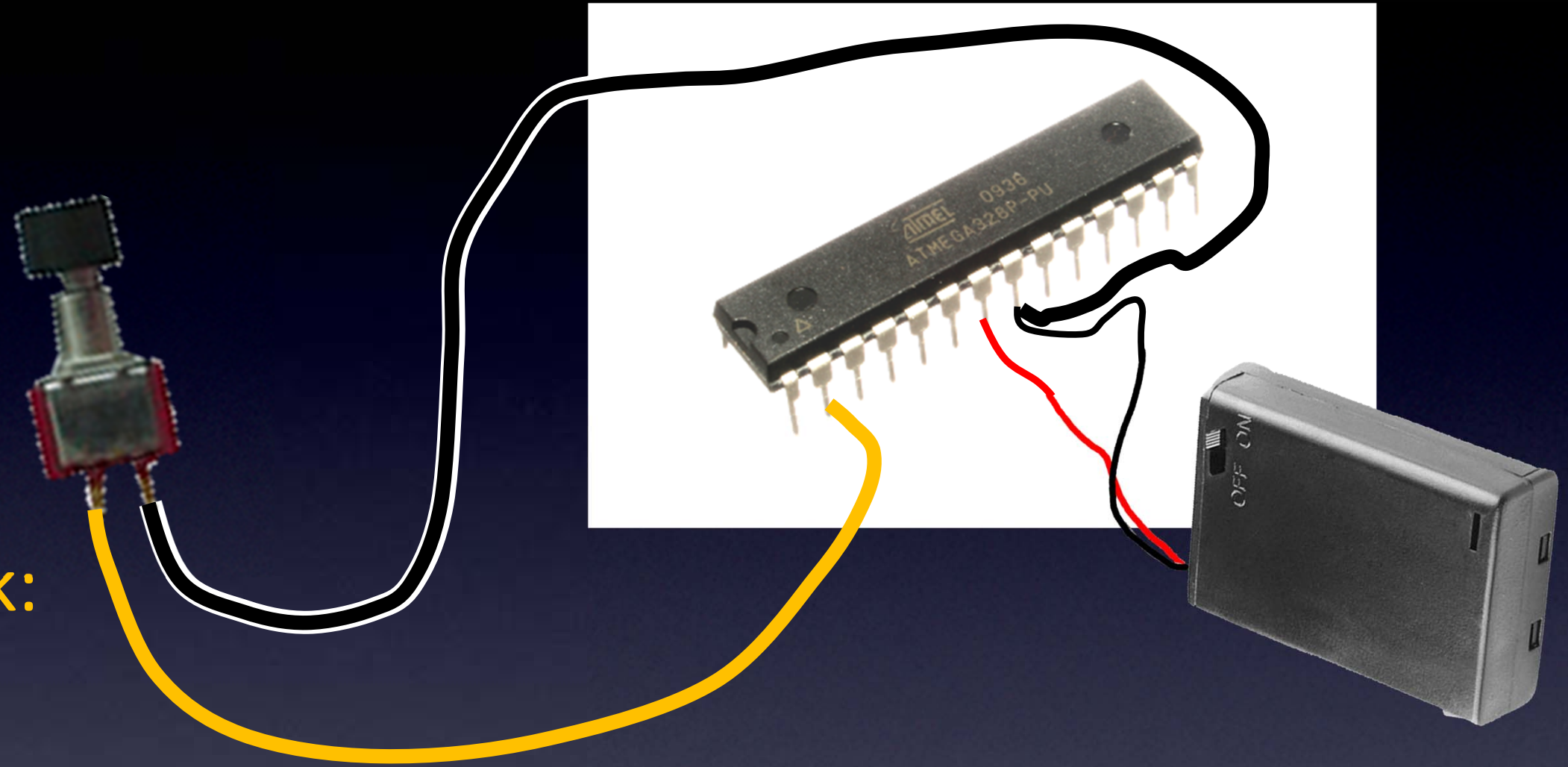

Reading the Input pin, with Switch

Microcontroller – Input pins

Everything You Need to Know About Electronics

Hardware

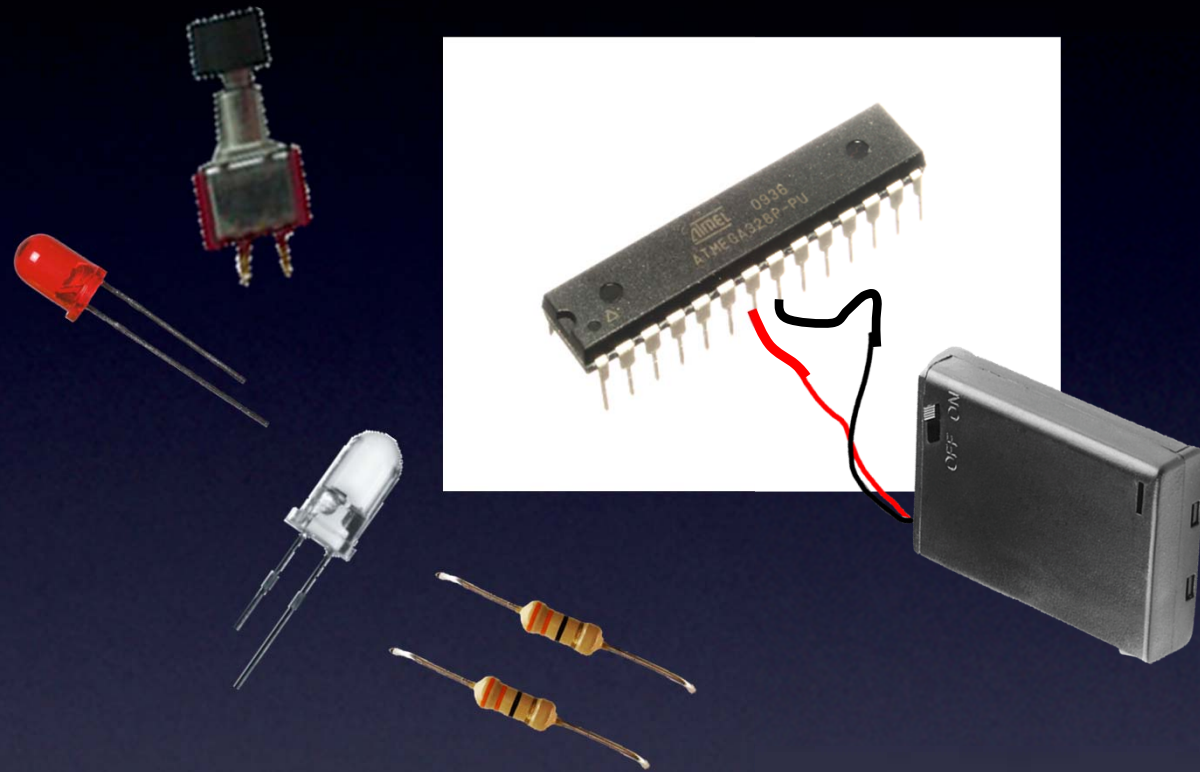

Firmware

Pin 13 Output – visible LED pin

Pin 3 Output – IR LED pin

Pin 2 Input – Push Button

Wait for Switch to be Low

Blink visible LED:

High, Delay, Low

Pulse IR LED for Sony “OFF” code:

High, Delay, Low, Delay...

Blink visible LED:

High, Delay, Low

Pulse IR LED for Panasonic “OFF” code:

High, Delay, Low, Delay...

Etc for all “OFF” codes

TV-B-Gone remote control

Microcontroller

Everything You Need to Know About Electronics

Hardware

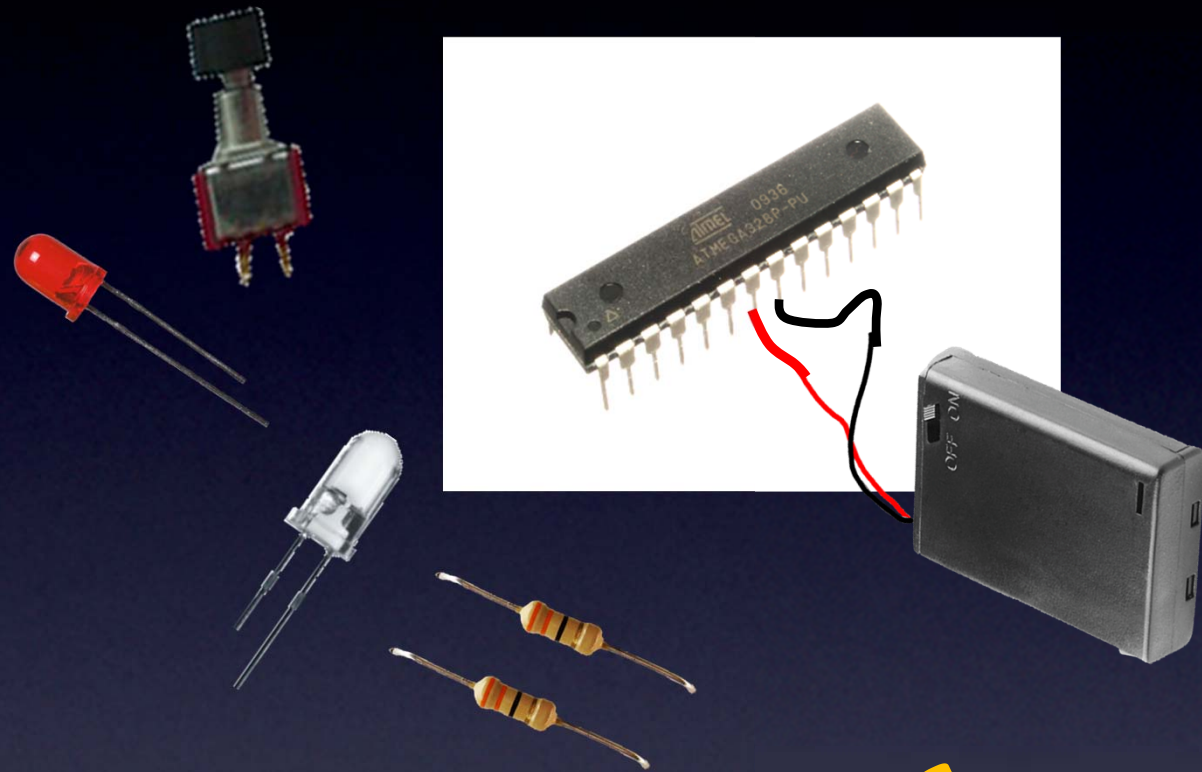

Except
doesn't go very far

Firmware

Pin 13 Output – visible LED pin

Pin 3 Output – IR LED pin

Pin 2 Input – Push Button

Wait for Switch to be Low

Blink visible LED:

High, Delay, Low

Pulse IR LED for Sony “OFF” code:

High, Delay, Low, Delay...

Blink visible LED:

High, Delay, Low

Pulse IR LED for Panasonic “OFF” code:

High, Delay, Low, Delay...

Etc for all “OFF” codes

TV-B-Gone remote control

Microcontroller

Everything You Need to Know About Electronics

Remember:

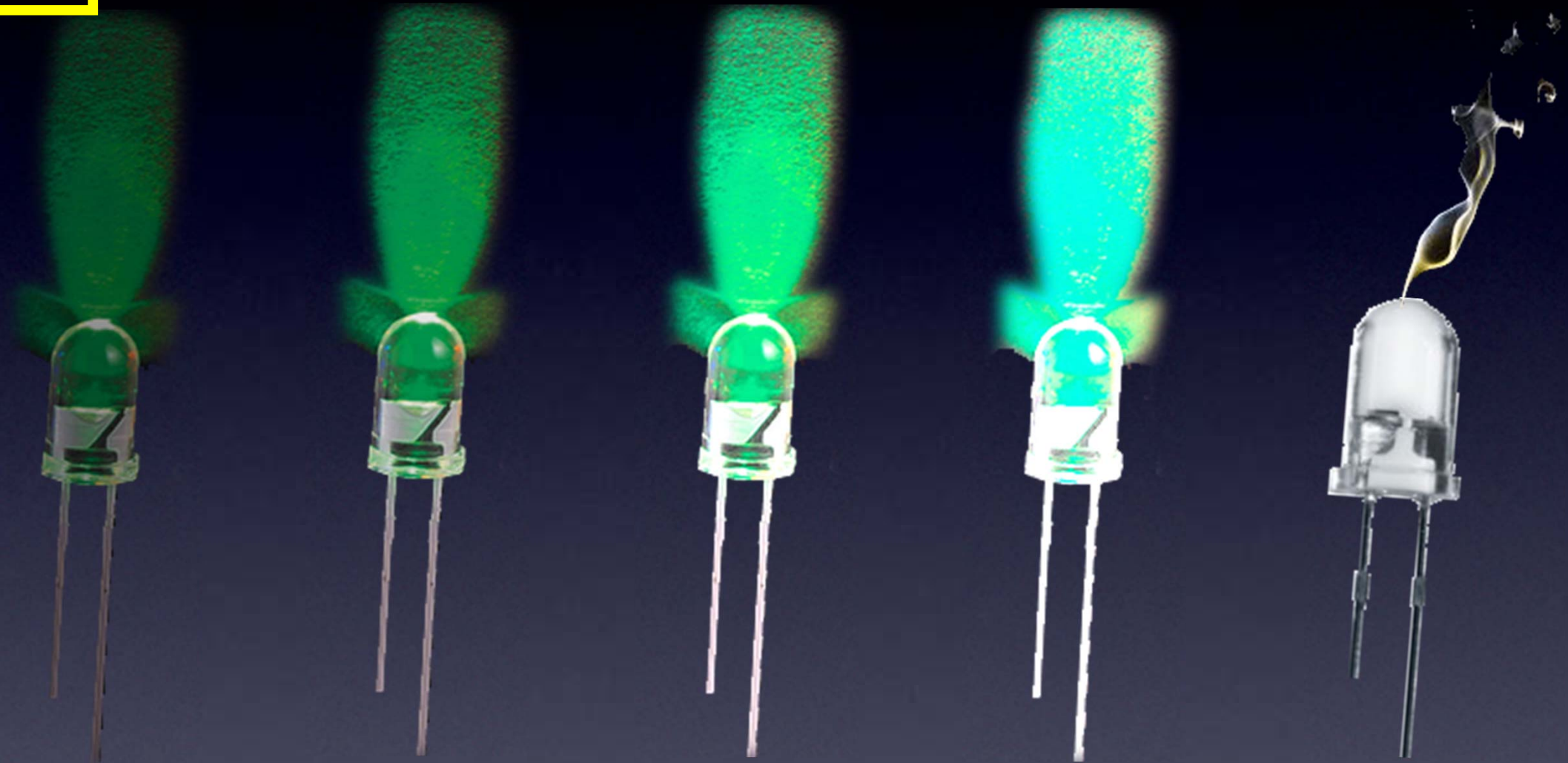

More current \rightarrow More brightness! (until...)

LED

Everything You Need to Know About Electronics

Microcontroller Output pin's

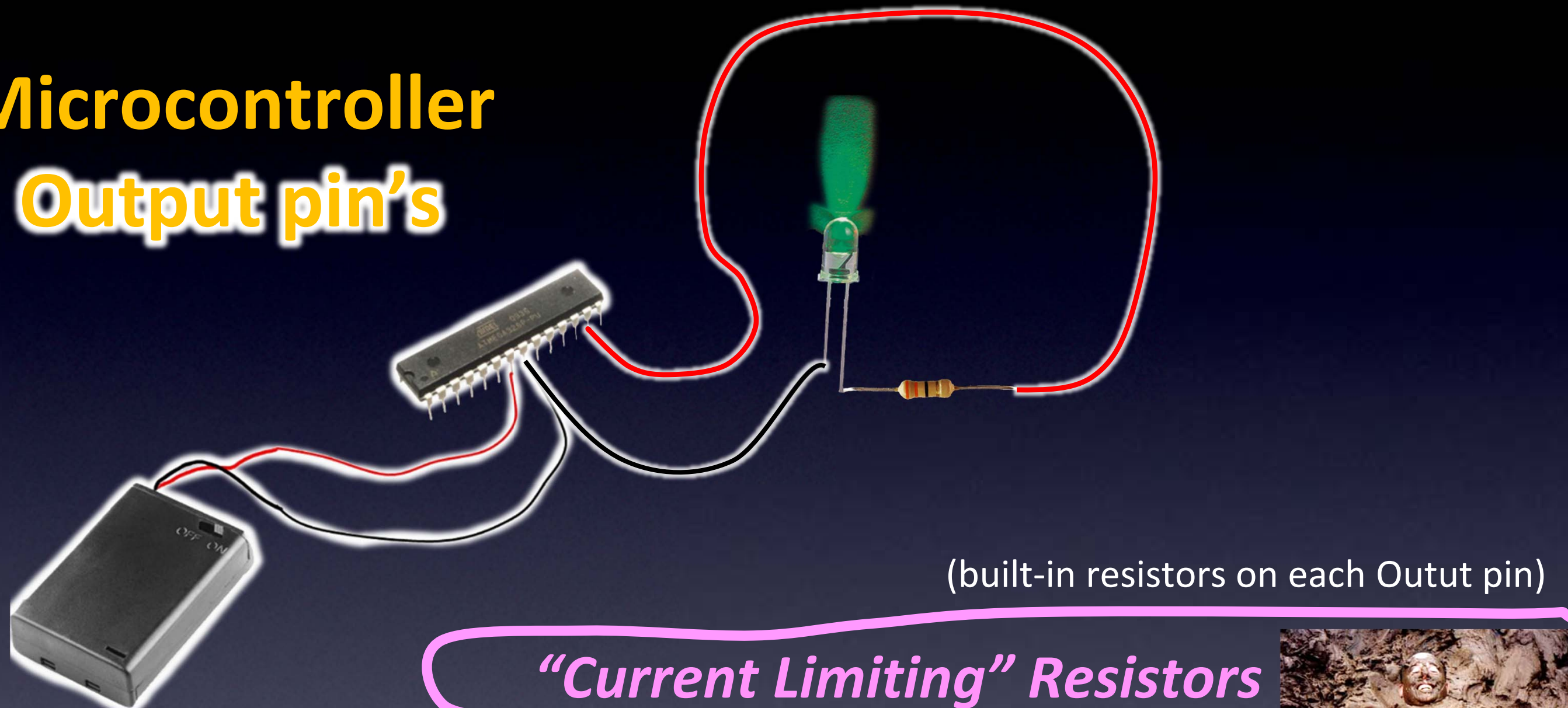

“Current Limiting” Resistors
are built-in
to the microcontroller’s
Output pins



Microcontroller – Output pins

Everything You Need to Know About Electronics

**Microcontroller
Output pin's**

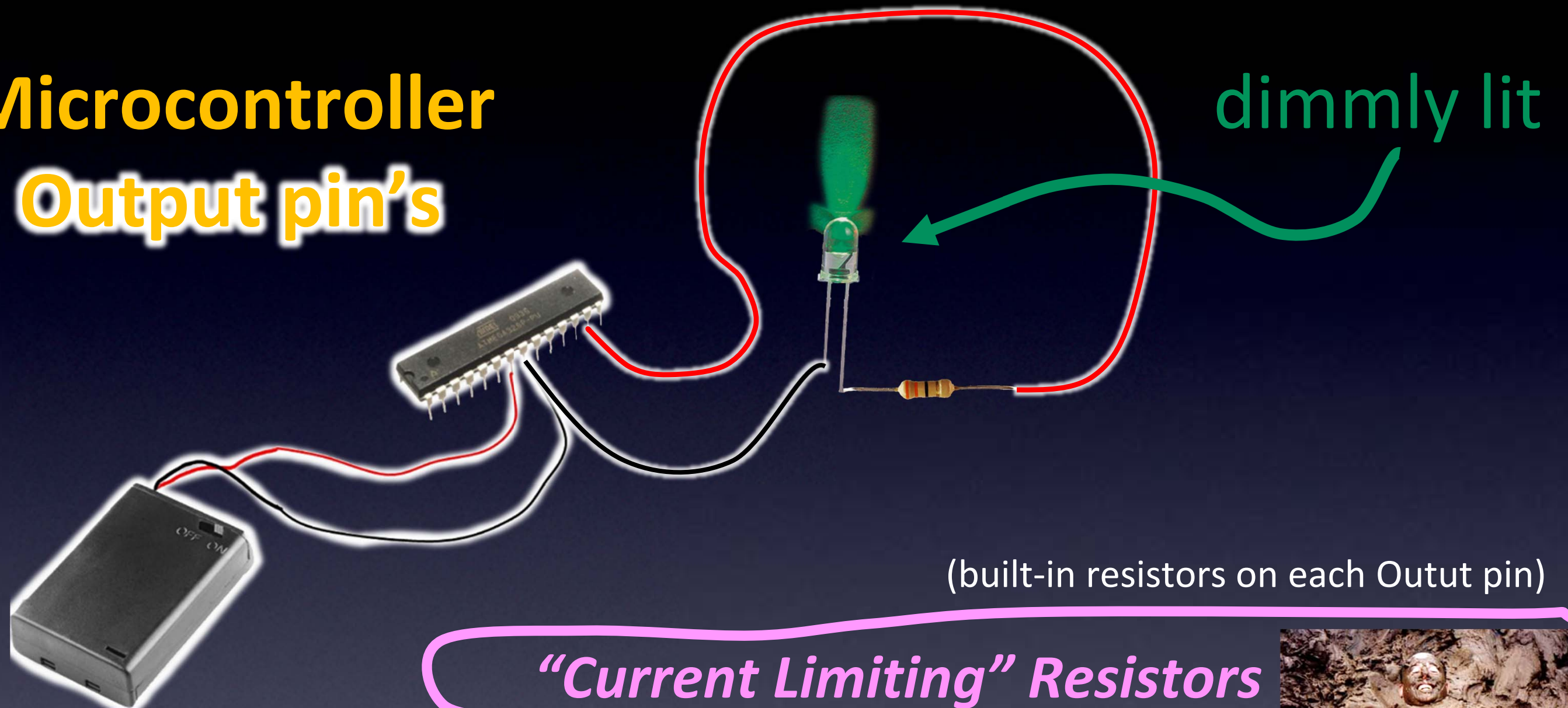

“Current Limiting” Resistors
are built-in
to the microcontroller’s
Output pins



Microcontroller – Output pins

Everything You Need to Know About Electronics

So,

let's amplify the current

from the Output pin

with

a

Current amplifier !

Everything You Need to Know About Electronics



Current amplifier !

Transistor

Everything You Need to Know About Electronics

Hardware

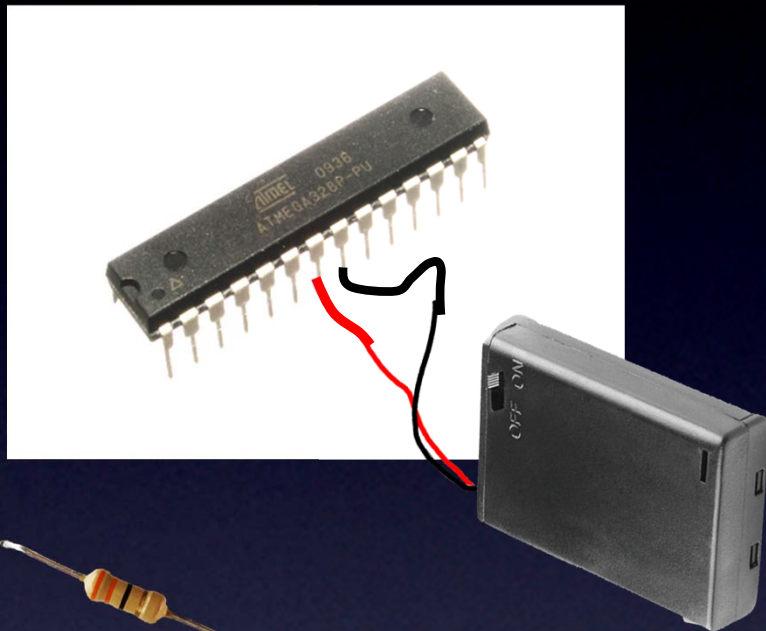

Add Transistor
(and a resistor so no magic smoke goes away)
and, we're done!

Firmware

Pin 13 Output – visible LED pin

Pin 3 Output – IR LED pin

Pin 2 Input – Push Button

Wait for Switch to be Low

Blink visible LED:

High, Delay, Low

Pulse IR LED for Sony “OFF” code:

High, Delay, Low, Delay...

Blink visible LED:

High, Delay, Low

Pulse IR LED for Panasonic “OFF” code:

High, Delay, Low, Delay...

Etc for all “OFF” codes

TV-B-Gone remote control – we're done!

Microcontroller

And, that is

And, that is

*Everything You Need to Know About
Electronics*

Questions?

Learn To Solder

We will not solder in this version of the workshop

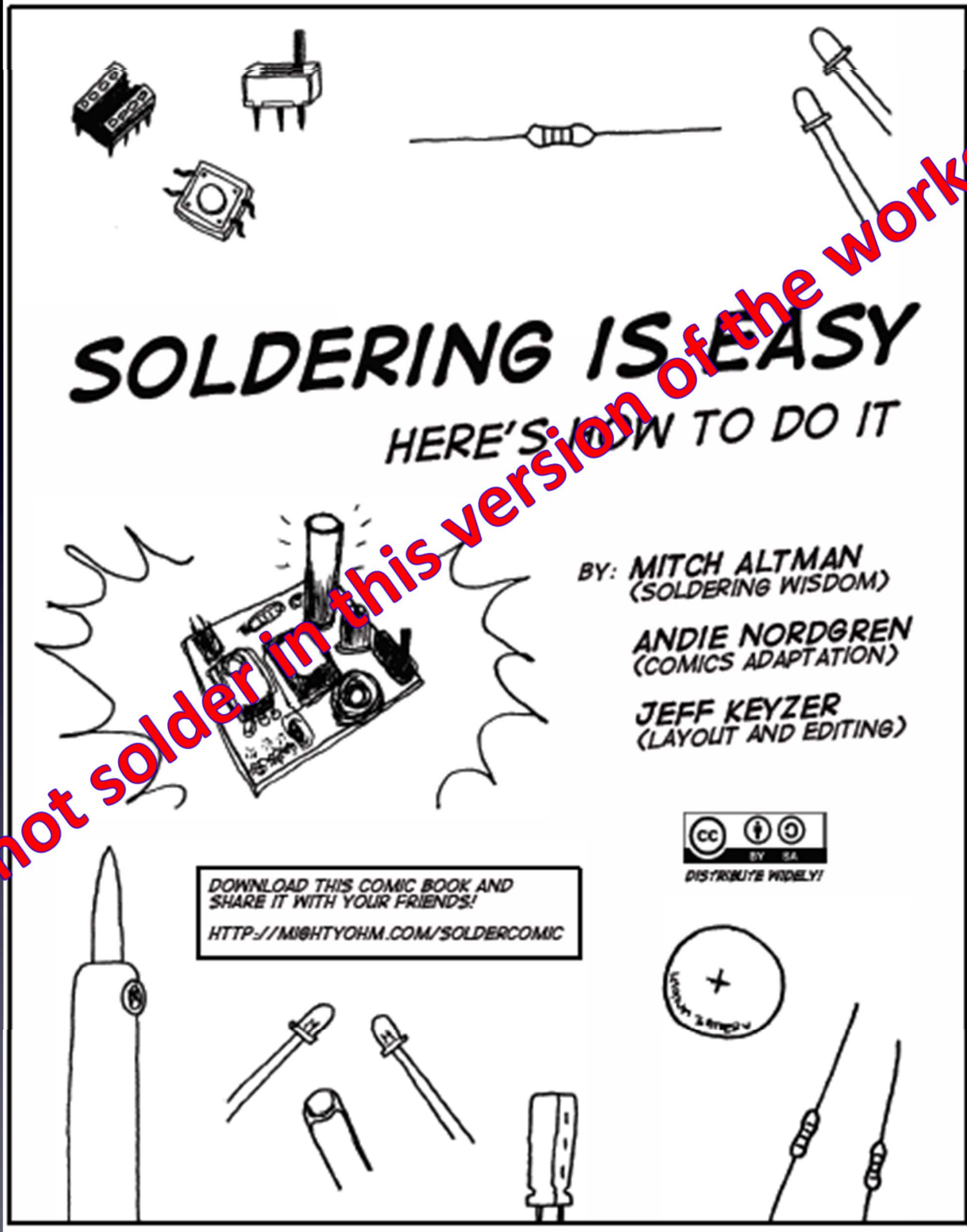

download for free at:

<http://mightyohm.com/soldercomic>

(In many different languages.)

Learn To Solder

SOLDERING IS EASY

HERE'S HOW TO DO IT

BY: MITCH ALTMAN
(SOLDERING WISDOM)

ANDIE NORDGREN
(COMICS ADAPTATION)

JEFF KEYZER
(LAYOUT AND EDITING)



DISTRIBUTE WIDELY!

DOWNLOAD THIS COMIC BOOK AND
SHARE IT WITH YOUR FRIENDS!
[HTTP://MIGHTYOHM.COM/SOLDERCOMIC](http://mightyohm.com/soldercomic)

We will not solder in this version of the workshop
(But, soldering really is easy!)

download for free at:

<http://mightyohm.com/soldercomic>

(In many different languages.)

We will not solder in this version of the workshop

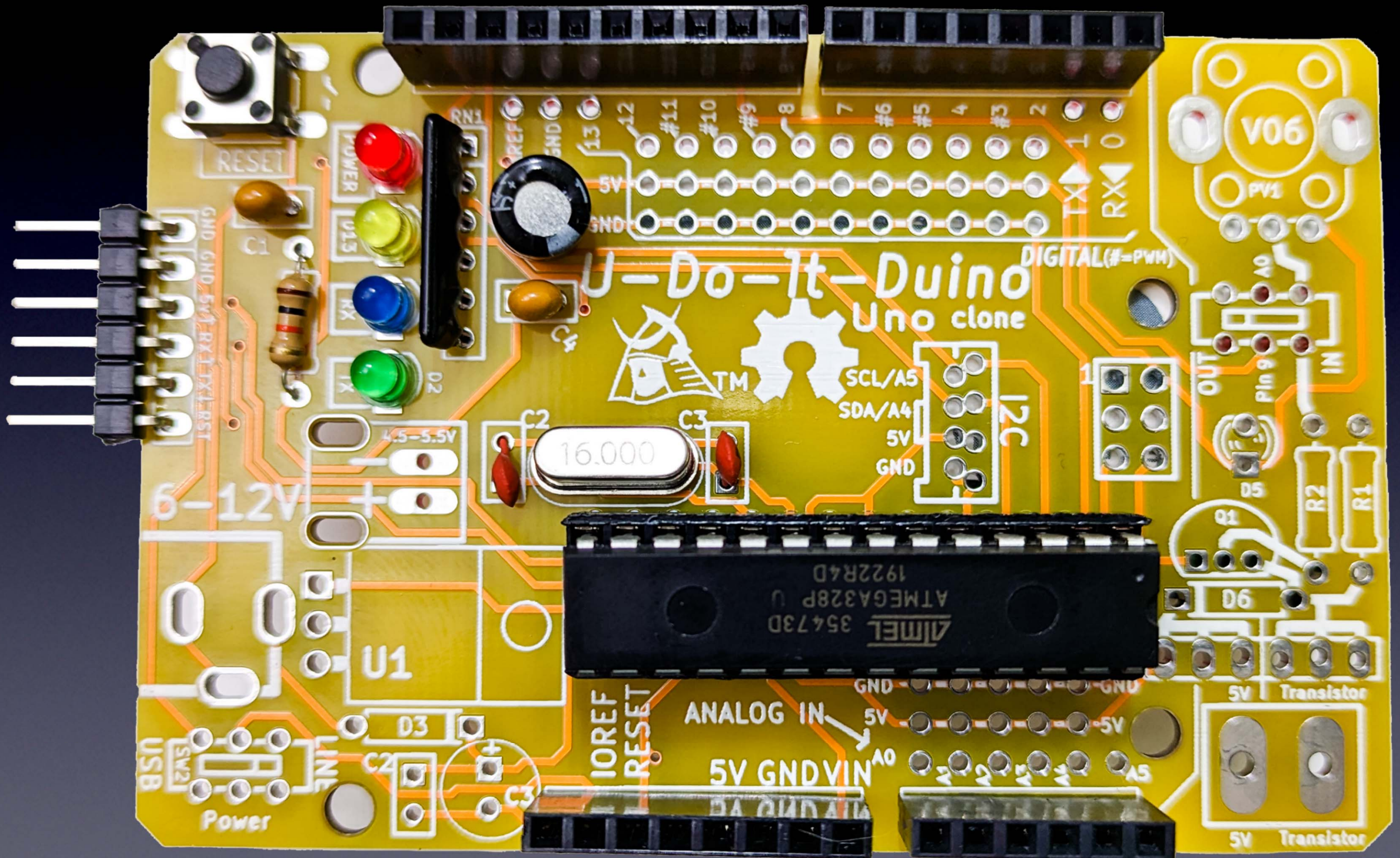

We will use a ready-made Arduino “Clone”

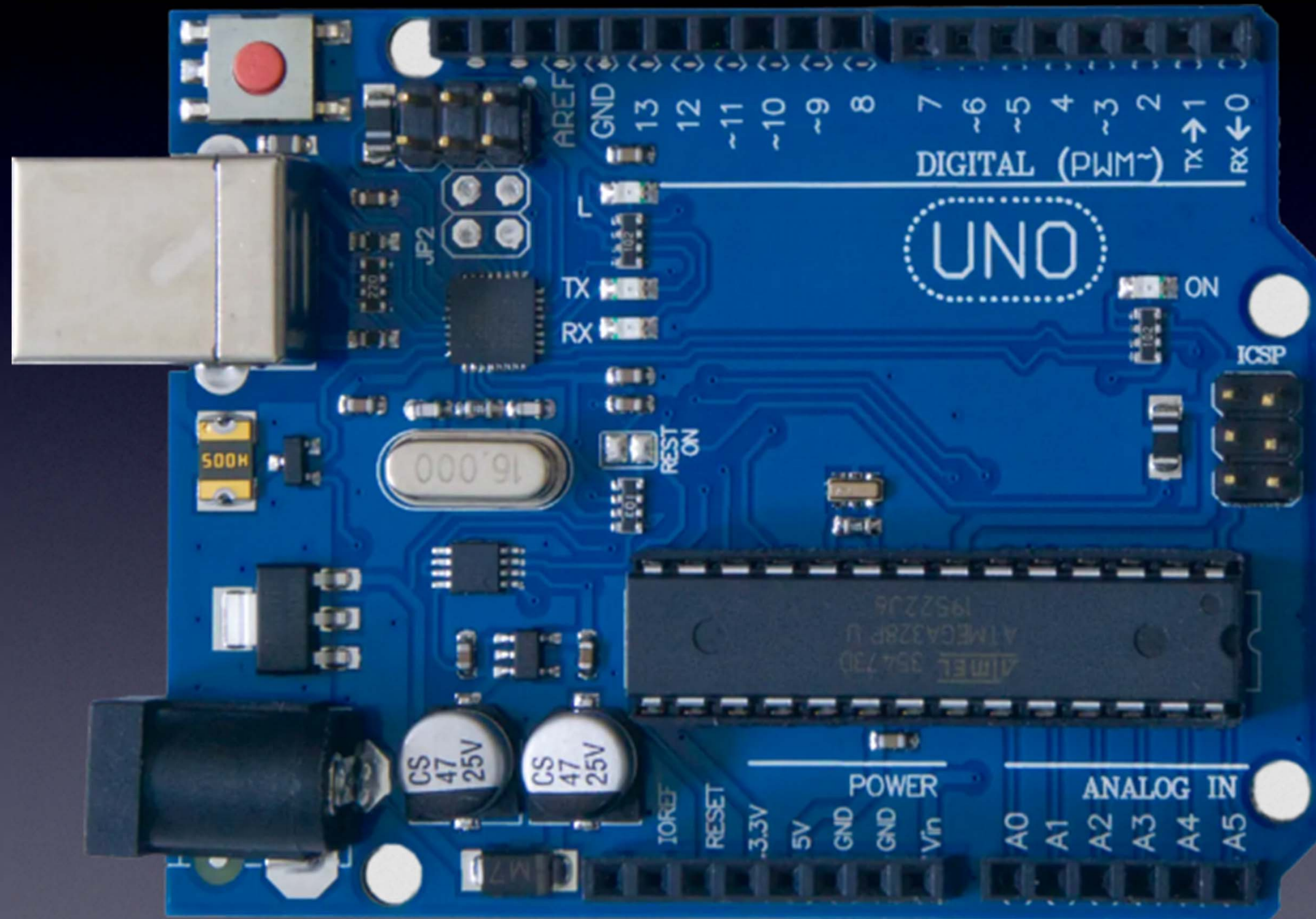

Uno clone

We will use a ready-made Arduino “Clone”

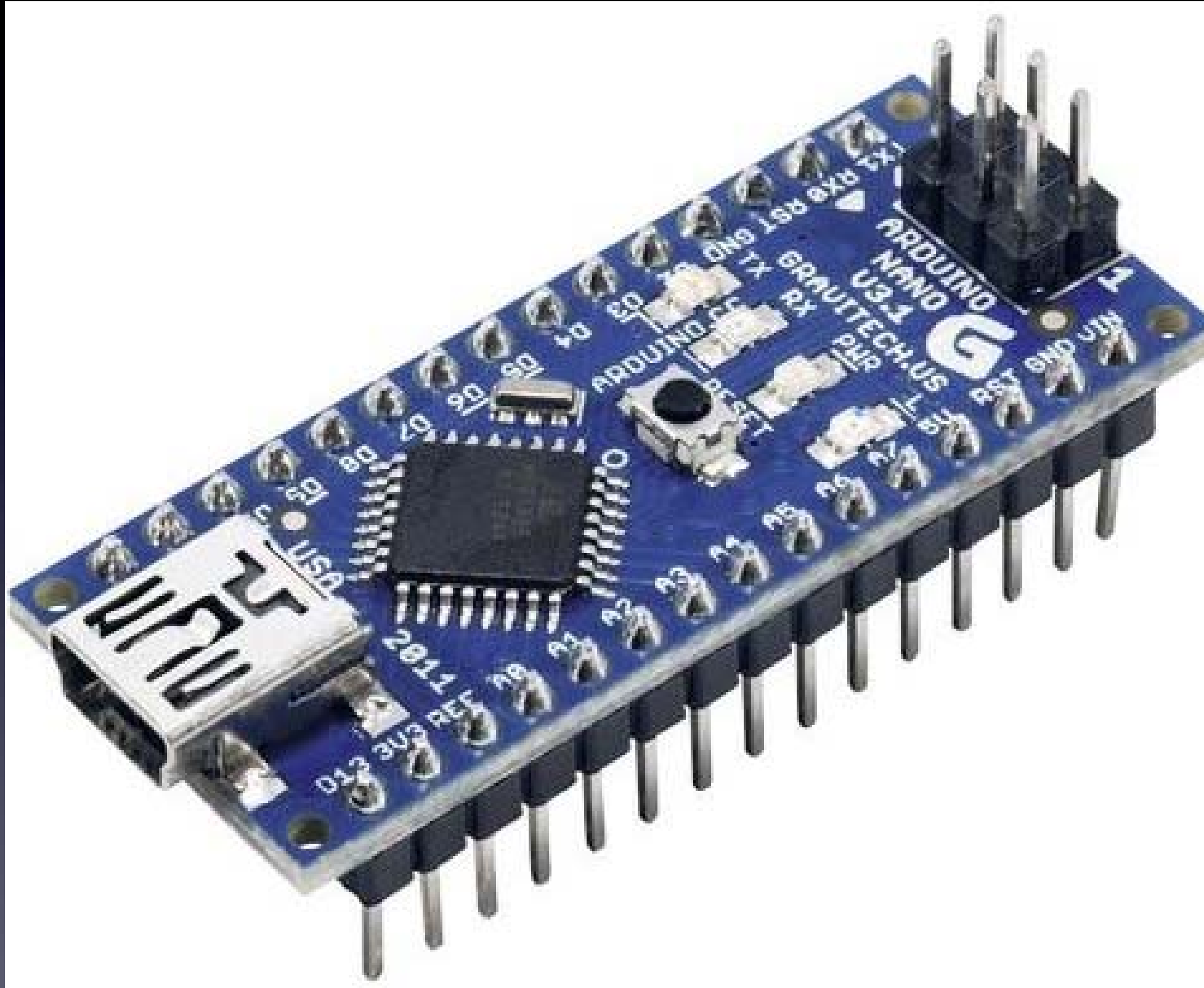

Nano clone

We can
connect parts to our Arduino,
and program it!

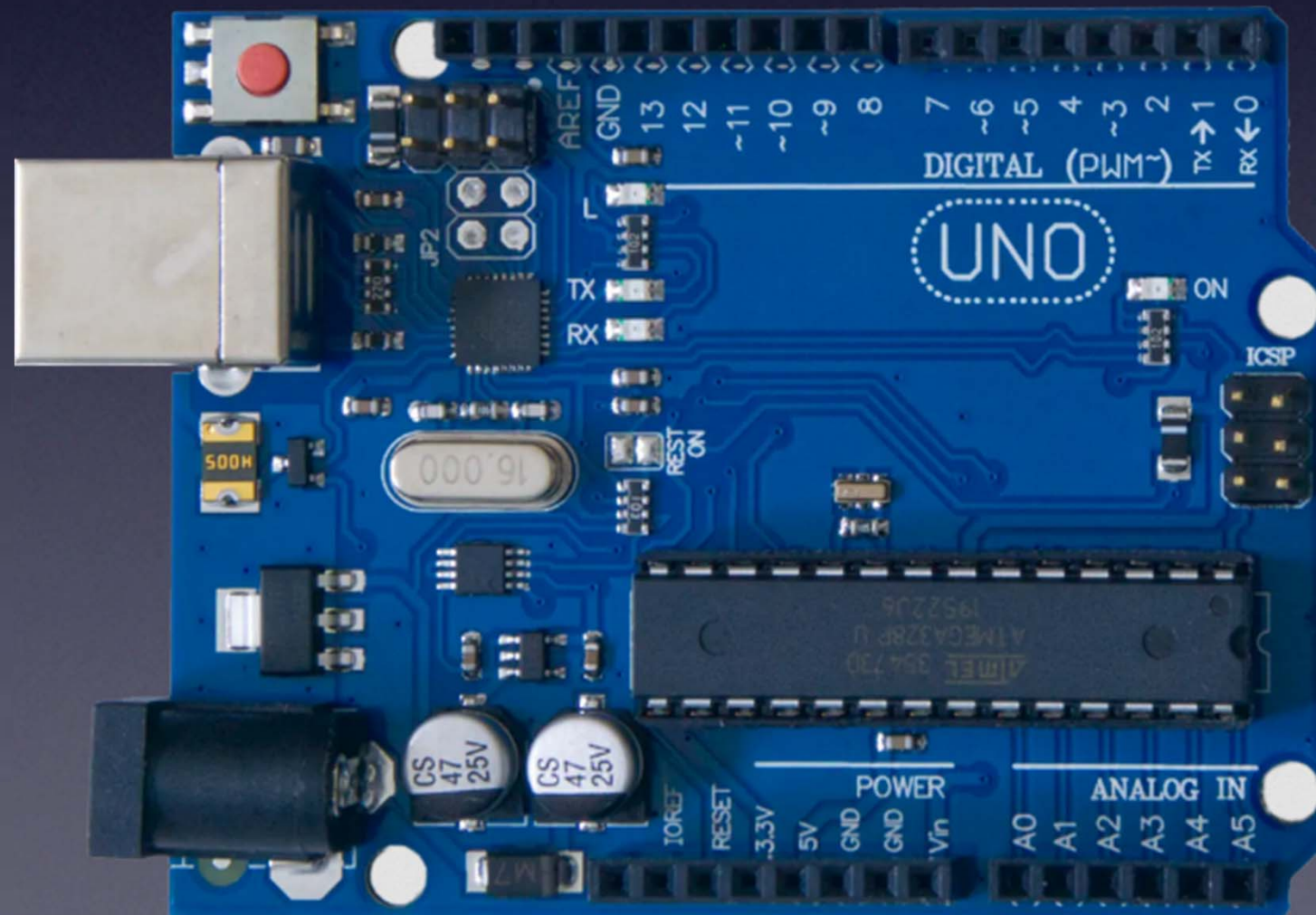

Helpful info

on the

Ardduino for(4) Total Newbies

workshop

web-page:

<https://tinyurl.com/A4TNworkshop>

USB-Serial Cable Driver

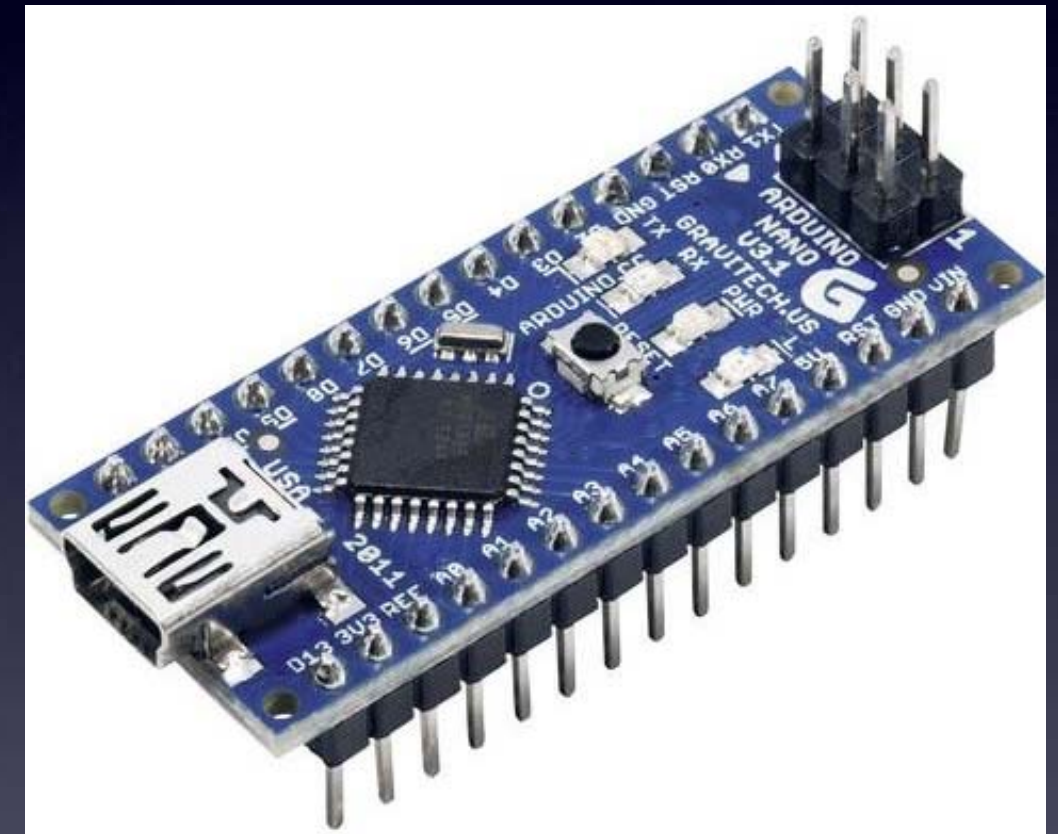
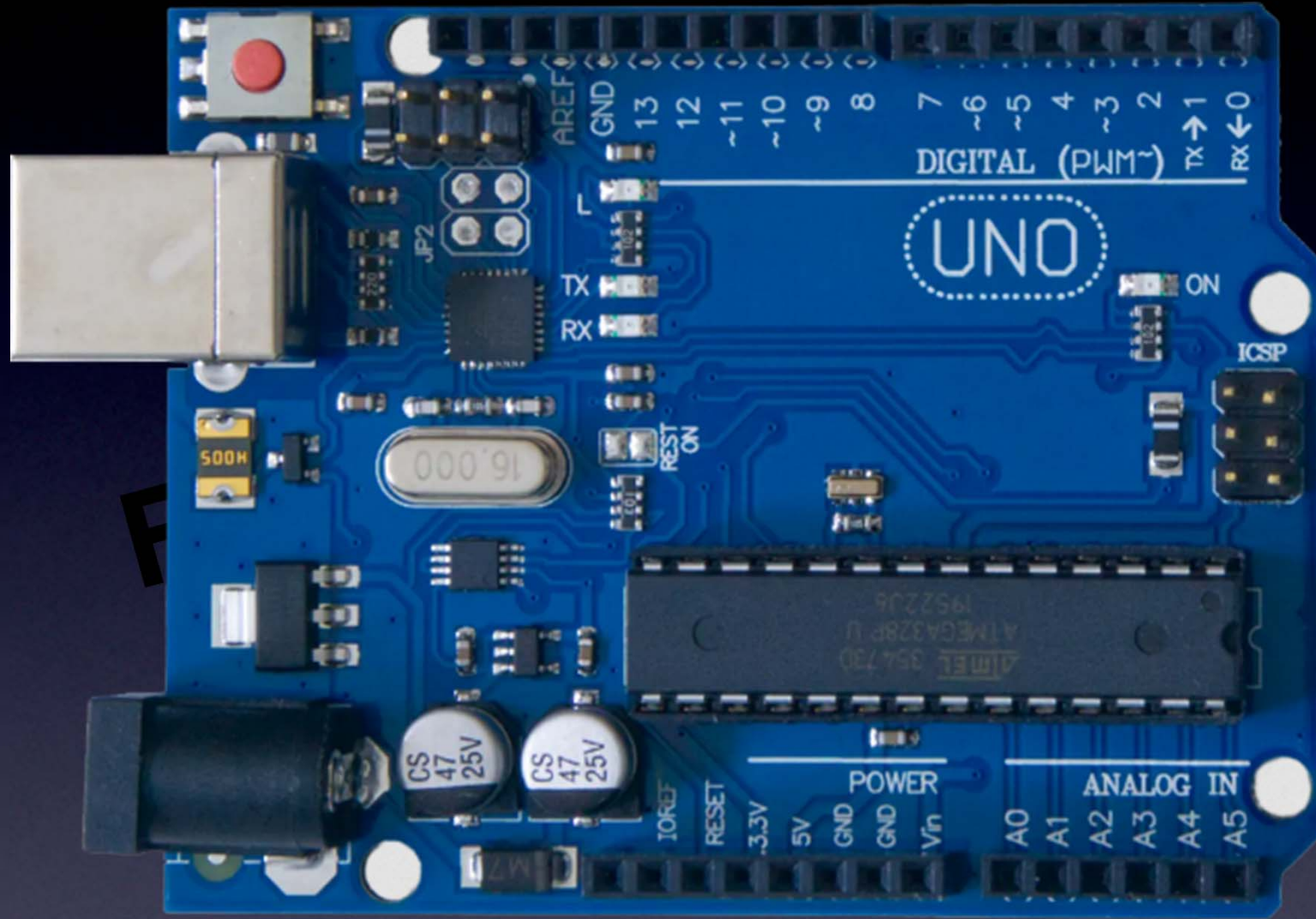

You may need to download and install a Serial Port driver for your Operating System (Windows, MacOS, or Linux)

Search for "CH340 driver"

Helpful info

on the

Ardduino for(4) Total Newbies

workshop

web-page:

<https://tinyurl.com/A4TNworkshop>



TAKE CONTROL

At Cornfield Electronics we create devices that give people opportunities for effective choices in their lives. Each of us can decide whether to watch TV monitors, and when to watch. Each of us can decide when to get the rest we want, and how we dream. Everyone can learn to make cool things with our kits. Please explore our [products](#), make your own choices, and see how *your* life can be enhanced.

[Join our mailing list](#)

Love it or hate it, TV screens are all around us. [TV-B-Gone](#)® universal remote control is the first fruit of our technical savvy, embodying our belief in empowerment, and sense of humor. This universal remote control fits in your pocket and allows you to discreetly turn TVs off wherever you go. TV-B-Gone fans around the world are using it for a variety of practical, philosophical, and humorous purposes. Imagine the possibilities...

Years in the making [NeuroDreamer](#) sleep mask is another of our personal empowerment inventions. We all need rest, but we don't always get it in our busy lives. NeuroDreamer sleep mask lets you use your own brainwaves to

bring you the rest you need. And with the [lucid dreaming model](#), you can take control of your dreams.

Want to learn electronics? We make way cool, fun, intriguing, educational [kits](#) that **anyone can make!** Our most **POPULAR** kits are: [ArduTouch music synthesizer kit](#) and [TV-B-Gone kit!](#)

We make truly useful technological solutions that put you in charge.

Welcome to our better world!

NOTE: As of 14-Feb-2023 Cornfield Electronics is a sole proprietorship of Mitch Altman.



DO-IT-YOURSELF PROJECTS

by *Mitch Altman*, and friends.
Last modified: 5-Oct-2022

You Can Make Cool Things With Electronics!

The projects on this page were all created for total beginners, with no experience, so everyone can complete them successfully at my workshops, or at home, or anywhere!

All you need is:

a desire, a handful of parts, a soldering iron (with stand and sponge), a wire-cutter, a wire-stripper, solder, and an afternoon.



[Here](#) is a really nice tutorial on how to solder -- for total beginners!
[Soldering Tutorial for total beginners](#)

Open Hardware!

Everything on this page (and everything I do) is free and open source!
(That's *free* as in *freedom*.)
(But everything here is free to download -- and that is *free* as in *beer*.)
If you have ANY questions on anything, please feel free to email me:
mitch AT CornfieldElectronics DOT com



Soldering!

Soldering is fun! And it is easy! Really, it is!
I have taught tens of thousands of people around the world how to solder.
Everyone can do it! All ages, all skill levels.
People who have never even sewn a button can easily learn to solder. Even you!
Once you learn how to make one good solder connection, you can make anything on this page.
And if you can make anything on this page, you can learn to make anything with electronics and microcontrollers.

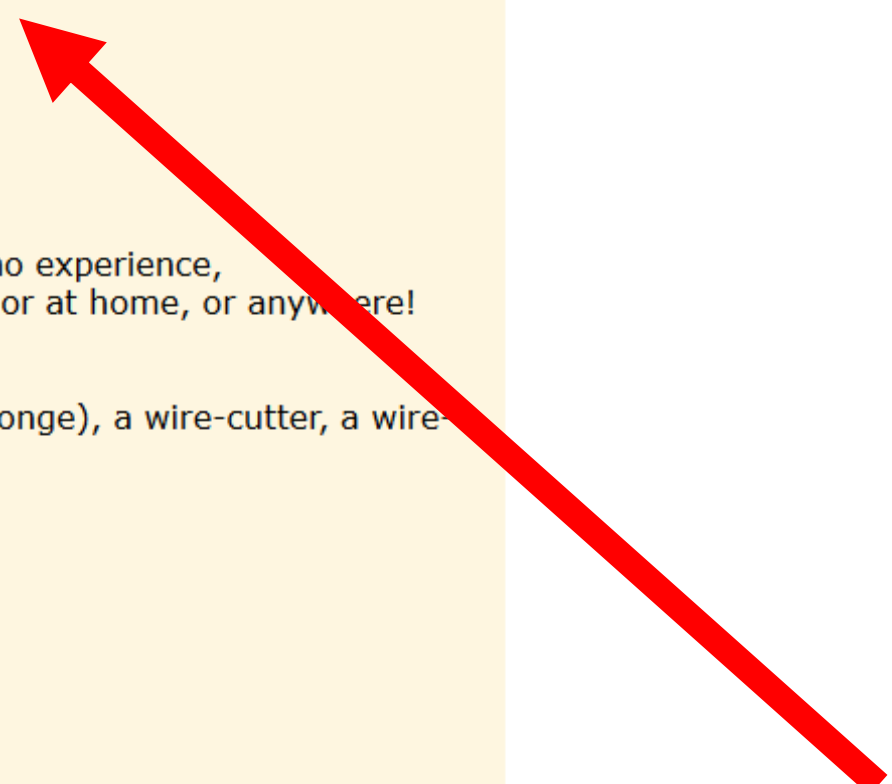

Project: Make your own open source TV-B-Gone Kit (developed with Ladayada)



The TV-B-Gone Kit was originally developed from a MiniPOV3 hack (see below) (which, of course, I hacked from my original [TV-B-Gone](#).)

For excellent **assembly instructions**, please go to the [TV-B-Gone Kit page](#) of the of the Adafruit.com website.

For **questions** about the TV-B-Gone Kit, please go to the [TV-B-Gone Kit user forum](#).
To see the **schematic, firmware, and board layout**, please go to [TV-B-Gone Kit downloads](#).

TV-B-Gone Kits are available for **purchase** from the [TVBGone.com](#) website.

Project: Arduino For Total Newbies workshop
-- Learn Arduino, and make your own TV-B-Gone!



This workshop covers lots of ground -- all you need to learn how to play with Arduinos. As an example project, you can make your own TV-B-Gone using [Arduino](#).
Many thanks to Ken Shirriff for the original [TV-B-Gone for Arduino project](#)!
For documentation on this workshop, please see the:
[Arduino For Total Newbies Workshop](#) page.

scroll down



Project: Make your own open source TV-B-Gone Kit (developed with Ladayada)



The TV-B-Gone Kit was originally developed from a MiniPOV3 hack (see below) (which, of course, I hacked from my original [TV-B-Gone](#).)

For excellent **assembly instructions**, please go to the [TV-B-Gone Kit page](#) of the of the Adafruit.com website.

For **questions** about the TV-B-Gone Kit, please go to the [TV-B-Gone Kit user forum](#).
To see the **schematic, firmware, and board layout**, please go to [TV-B-Gone Kit downloads](#).

TV-B-Gone Kits are available for **purchase** from the [TVBGone.com](#) website.

Project: Arduino For Total Newbies workshop
-- Learn Arduino, and make your own TV-B-Gone!



This workshop covers lots of ground -- all you need to learn how to play with Arduinos.

As an example project, you can make your own TV-B-Gone using [Arduino](#).

Many thanks to Ken Shirriff for the original [TV-B-Gone for Arduino project](#)!

For documentation on this workshop, please see the:

[Arduino For Total Newbies Workshop page](#).

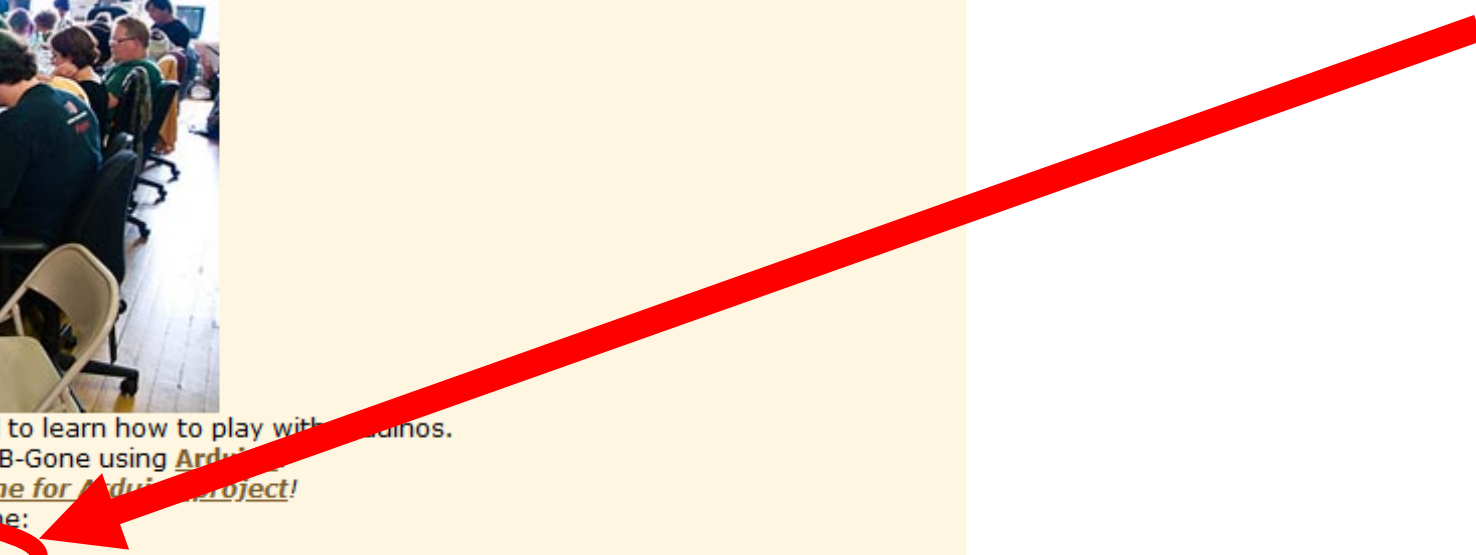



Arduino For Total Newbies Workshop

last updated: 1-May-2023

Learn how to make your own way cool projects with Arduino, using TV-B-Gone as an example project to learn from.



I've given this workshop at [Noisebridge](#) hackerspace in San Francisco (several times), at [27C3](#) and [28C3](#) in Berlin, and [29C3](#), [30C3](#), [31C3](#), [32C3](#), and [33C3](#) in Hamburg, and at [34C3](#), [35C3](#), [36C3](#) in Leipzig, and [RC3](#) online, at [CCCamp2011](#) [CCCamp2015](#) and [CCCamp2019](#) outside of Berlin, at [HeatSync Labs](#) hackerspace in Phoenix, AZ, at [Fabelier](#) hackerspace in Paris, at Unit One in [2012](#), [2014](#), [2016](#), and [2018](#) as Hacker In Residence at the University of Illinois, in Urbana, IL, at Makerspace Urbana in Urbana, IL in [2012](#) and in [2016](#), at [Workshop Weekend](#) in Oakland, CA (twice), at [XinCheJian](#) hackerspace in Shanghai, at [Maker Carnival](#) in Beijing (twice) at several conferences and hackerspaces on my [Hackers on a Train Workshop Tour 2012](#) including at [HOPE Number 9](#) in New York City, at [ToorCamp 2012](#) in Neah Bay, WA, at [OHM 2013](#) and [SHA 2017](#) outside of Amsterdam, at [RockIT CoLabs](#) in San Francisco, at [BalcCon2k14](#) in Novi Sad, Serbia, at [HOPE X](#), [The Eleventh HOPE](#), [The Circle of HOPE A New HOPE](#) in New York City, and [HOPE 2020](#) online, at [the iCenter](#) as Hacker In Residence at Tsingua Univeristy in Beijing, at [EMF Camp 2016](#), [EMF Camp 2018](#), and [EMF Camp 2022](#), outside of London, at [Tami](#) hackerspace in Tel Aviv, at [Le Wagon](#) and [Zhongxi](#) in Chengdu, at [Astralship](#) hackerspace in North Wales (three times), at [Open Source Microfactory Build Camp](#) online, at [Newline](#) in Ghent, at [GPN20](#) in Karlsruhe, at [Fri3d Camp 2022](#) near Sint-Joris-Weert, Belgium, at [Maker Faire Brno 2022](#) in Brno, Czech Republic, at [HiP-Berlin](#) in Berlin, Germany, and lots of other places.

Each time 10 to 50 people show up. (Folks seem to like it.)

Itinerary for Arduino For Total Newbies Workshop:

Here is what is available for downloading for the Arduino For Total Newbies Workshop:

1) If you don't already have **Arduino software** you need to download it for your computer (Windows, Mac OS, or Linux):
[Arduino download page](#)

2) You need a **driver for your USB communications/programming cable**. Several different ones are available. Choose the driver for the cable you have and the operating system for your computer.

Samurai Circuits board (SiLabs CP210x USB-to-Serial TTL) drivers:
[The latest drivers from SiLabs' website](#)
The SiLabs driver is installed by default on most Linux systems.

Adafruit FTDI Friend drivers:
[The latest drivers from FTDI's website](#)
The FTDI driver is installed by default on most Linux systems.

FTDI Cable drivers:
[The latest drivers from FTDI's website](#)
The FTDI driver is installed by default on most Linux systems.

3) You also need the **TV-B-Gone Arduino Sketch** (download this, unzip it, and copy it to your computer in the "examples" folder inside your "arduino" folder that you downloaded):
[TV-B-Gone Arduino sketch\(22KB\)](#)

4) Schematic Diagram for Arduino TV-B-Gone remote control:
[Schematic Diagram\(449KB\)](#)

Parts List for Arduino TV-B-Gone remote control:
[Parts List \(Open Office\)\(12KB\)](#)
[Parts List \(MS Office\)\(9KB\)](#)

Schematics for the U-Do-It-Duino Arduino clone kit:
[U-Do-It-Duino schematic \(110KB\)](#)

Complete assembly instructions for the U-Do-It-Duino Arduino clone kit:
[U-Do-It-Duino complete assembly instructions](#)

Stuff to download

scroll down





The SiLabs driver is installed by default on most Linux systems.

Adafruit FTDI Friend drivers:

[The latest drivers from FTDI's website](#)

The FTDI driver is installed by default on most Linux systems.

FTDI Cable drivers:

[The latest drivers from FTDI's website](#)

The FTDI driver is installed by default on most Linux systems.

3) You also need the TV-B-Gone Arduino Sketch

(download this, unzip it, and copy it to your computer in the "examples" folder inside your "arduino" folder that you downloaded):

[TV-B-Gone Arduino sketch\(22KB\)](#)

4) Schematic Diagram for Arduino TV-B-Gone remote control:

[Schematic Diagram\(449KB\)](#)

Parts List for Arduino TV-B-Gone remote control:

[Parts List \(Open Office\)\(12KB\)](#)

[Parts List \(MS Office\)\(9KB\)](#)

Schematics for the U-Do-It-Duino Arduino clone kit:

[U-Do-It-Duino schematic \(110KB\)](#)

Complete assembly instructions for the U-Do-It-Duino Arduino clone kit:

[U-Do-It-Duino complete assembly instructions](#)

Soldering Is Easy comic book:

[Solder Comic \(English\) \(809KB\)](#)

[Many other languages are available!](#)

Here are links to the slides I use in the workshop:

[Arduino For Total Newbies workshop slides \(with U-Do-It-Duino kit\) \(69.2MB\)](#)

[Arduino For Total Newbies workshop slides \(with Arduino Uno -- no soldering\) \(56.0MB\)](#)

scroll down



Slides for this workshop

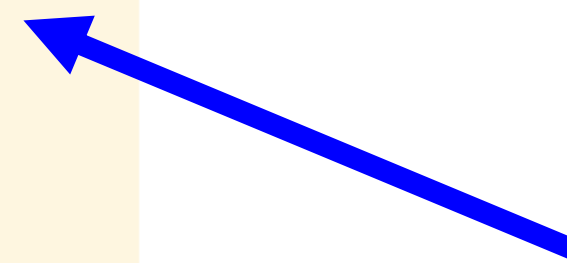

1) If you don't already have **Arduino software** you need to download it for your computer (Windows, Mac OS, or Linux):

[Arduino download page](#)

Arduino software:
Any version you have is fine !

File Edit View History Bookmarks Tools Help

Cornfield Electronics :: Projects X Cornfield Electronics :: Arduino X Arduino - Software X

https://www.arduino.cc/en/Main/Software

ARDUINO

HOME STORE SOFTWARE EDUCATION RESOURCES COMMUNITY HELP

SOFTWARE ENGLISH

ARDUINO WEB EDITOR

Start coding online with the [Arduino Web Editor](#), save your sketches in the cloud, and always have the most up-to-date version of the IDE, including all the contributed libraries and support for new Arduino boards.

GETTING STARTED

CODE ONLINE

Download the Arduino IDE

Windows Installer, for Windows XP and up
Windows ZIP file for non admin install

2) You need a **driver for your USB communications/programming cable.** Several different ones are available. Choose the driver for the cable you have and the operating system for your computer.

Samurai Circuits board (SiLabs CP210x USB-to-Serial TTL) drivers:

[The latest drivers from SiLabs' website](#)

The SiLabs driver is installed by default on most Linux systems.

NOTE:
Info here is not for this workshop:

For this workshop:

You may need to download and install a Serial Port driver for your Operating System (Windows, MacOS, or Linux)

Search for
"CH340 driver"

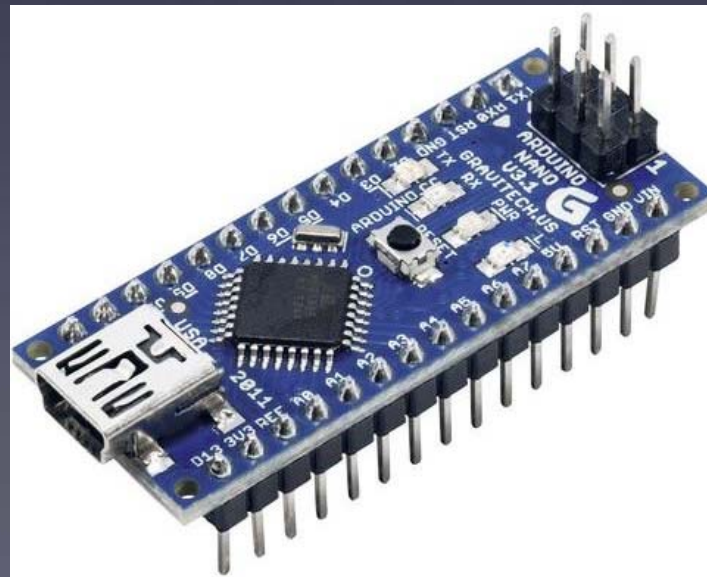
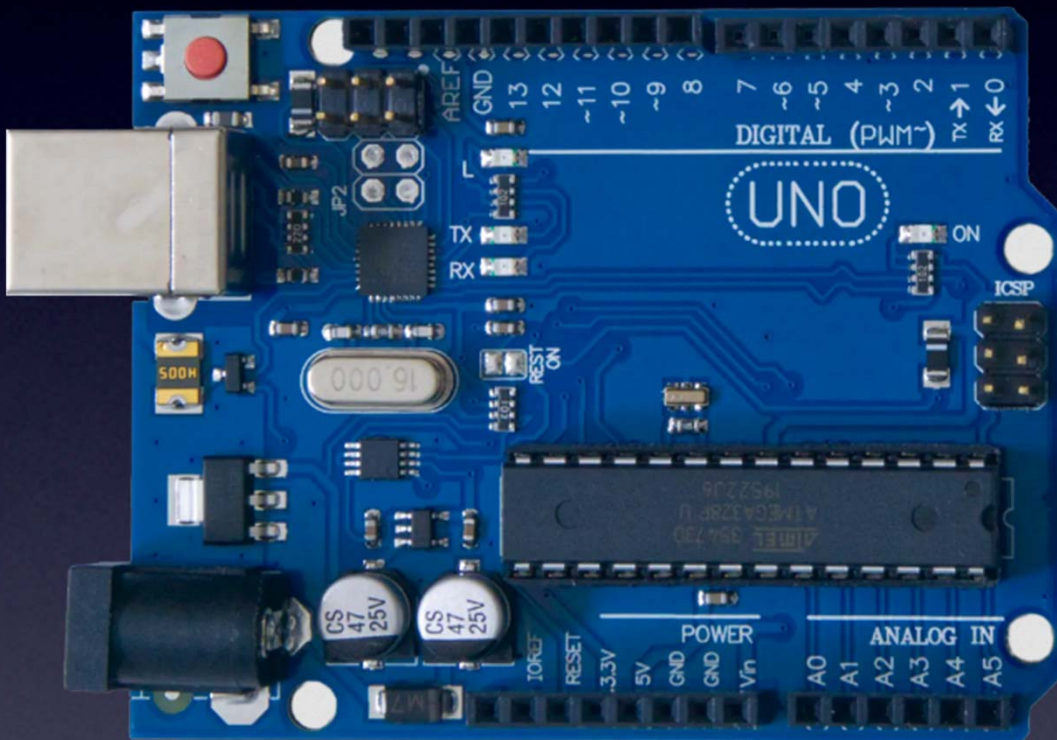

3) You also need the **TV-B-Gone Arduino Sketch** (download this, unzip it, and copy it to your computer in the "examples" folder inside your "arduino" folder that you downloaded):

[TV-B-Gone Arduino sketch\(22KB\)](#)

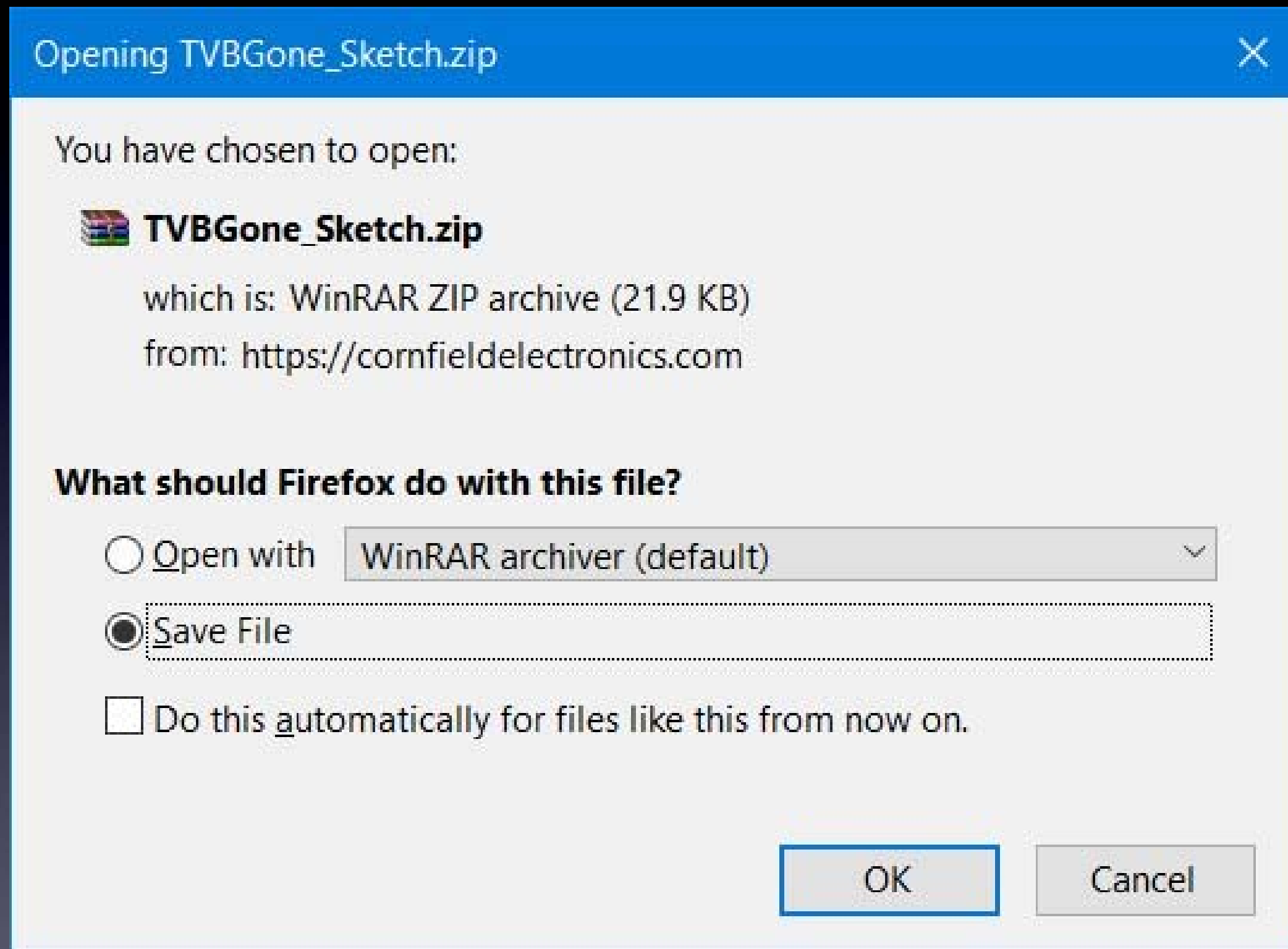

4) Schematic Diagram for Arduino TV-B-Gone remote control: Schematic Diagram(449KB)

File Edit View History Bookmarks Tools Help

Cornfield Electronics :: Projects X Cornfield Electronics :: Arduino X arduino_tvbgone_schematic.pdf X +

https://cornfielelectronics.com/cfe/projects/tvbg_arduino/arduino_tvbgone_schematic.pdf

1 of 1 70%

Arduino For Total Newbies

4-Sep-2015

Mitch Altman (original TV-B-Gone hardware and firmware, modified TV-B-Gone Arduino design)
Limore Fried (firmware modifications, kit design)
Ken Shirriff (original modifications for Arduino)
Johannes Schneemann (documentation)

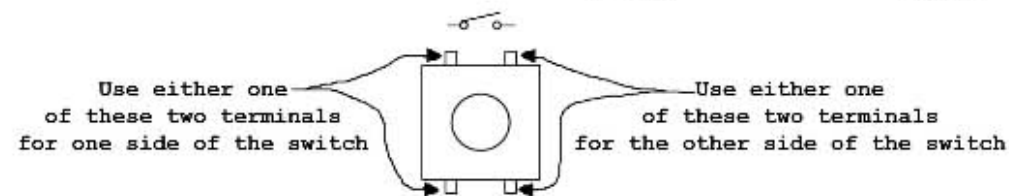
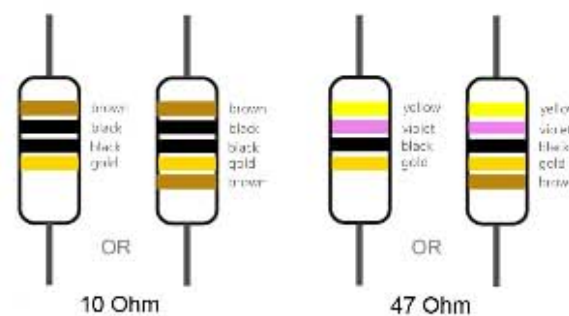
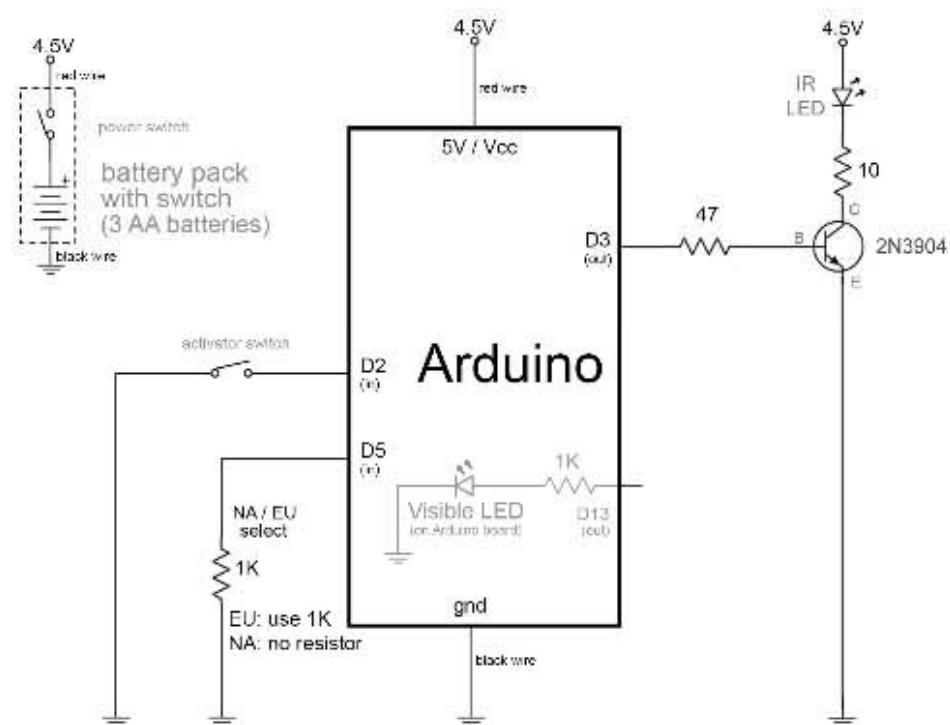

Connect your Arduino to your computer

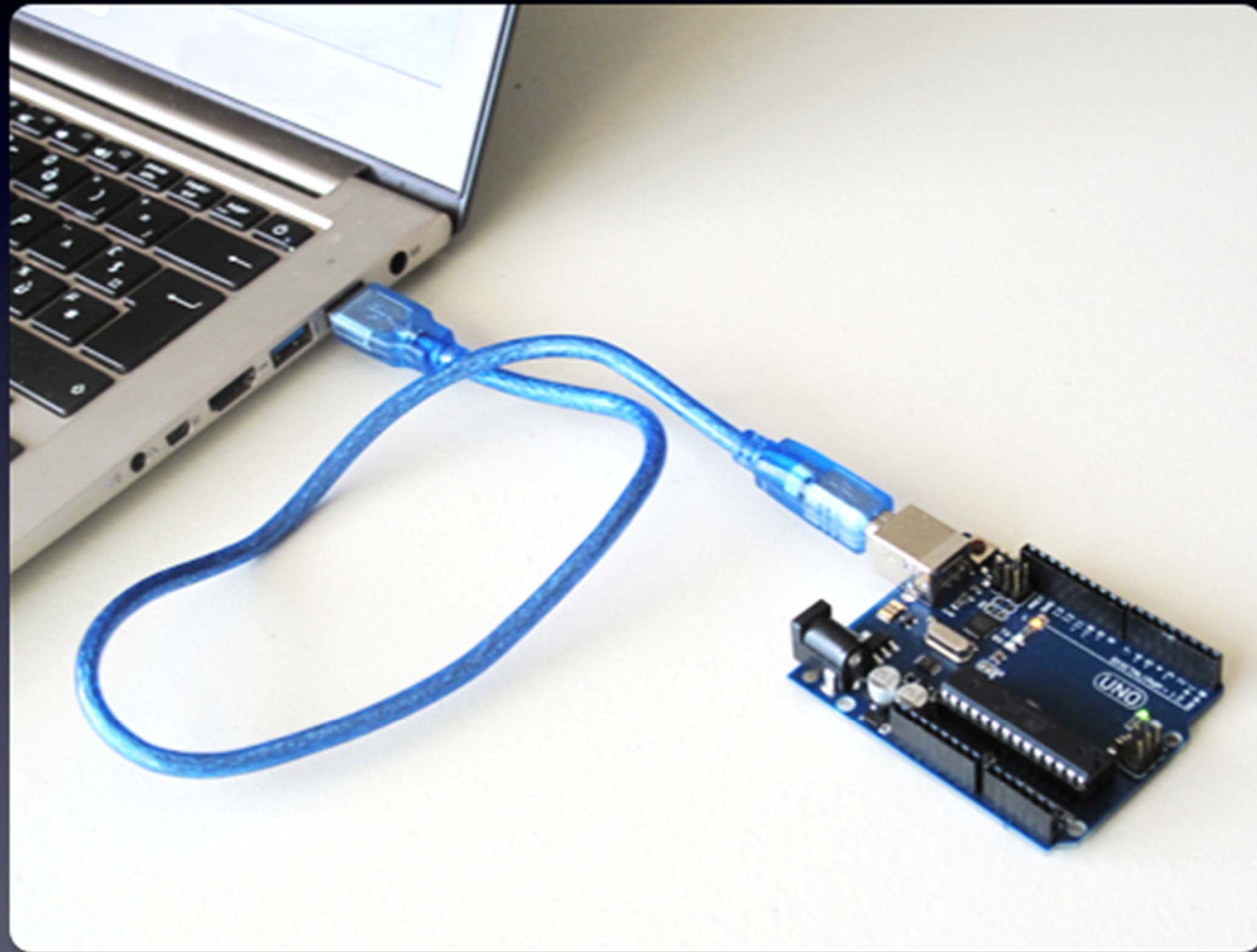

Connect your Arduino to your computer

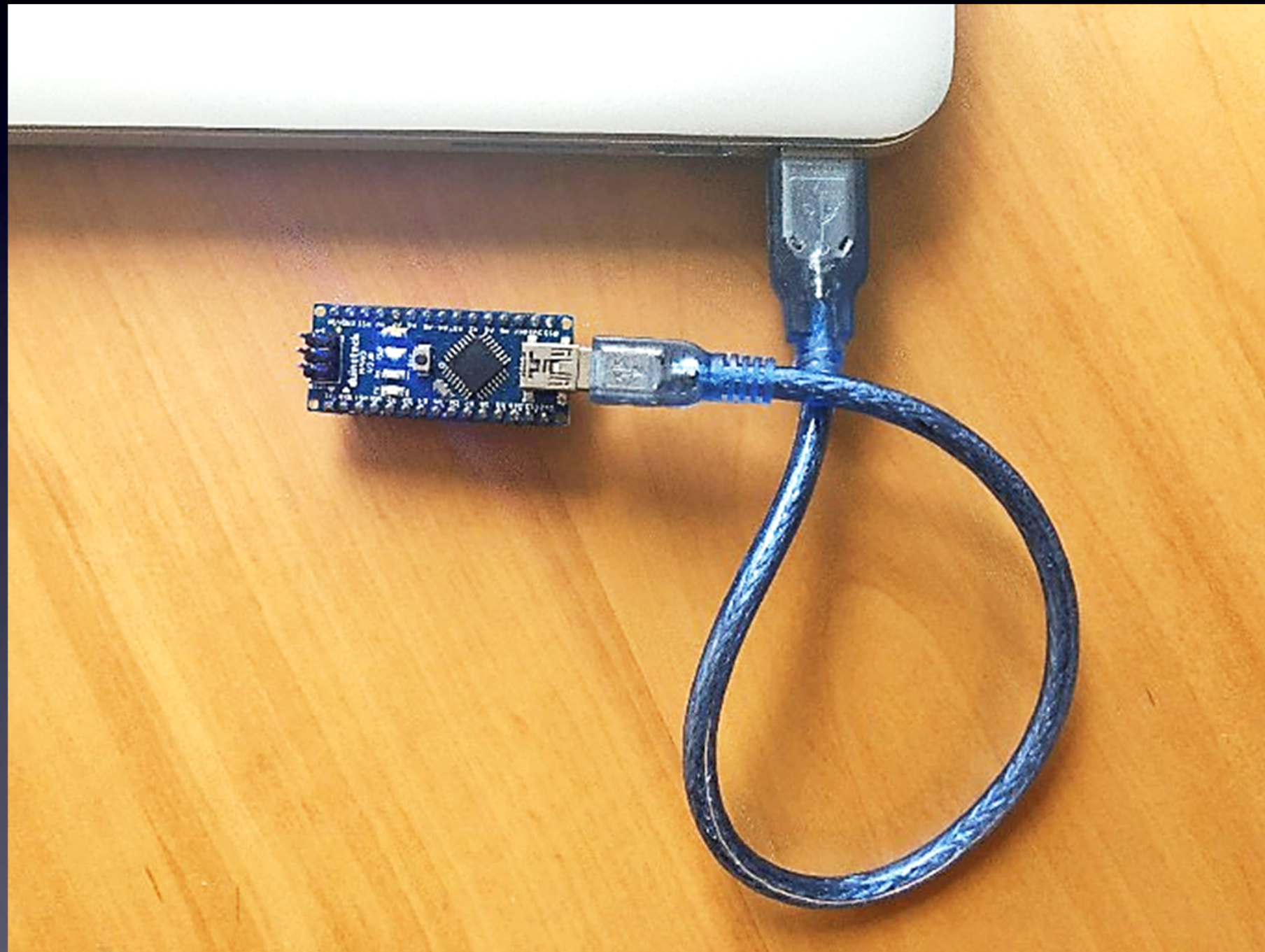

Arduino

After you download and install the Arduino software start it, and you will see a screen that looks like this:



The screenshot displays the Arduino IDE 2.1.0 interface. The window title is "sketch_may1a | Arduino IDE 2.1.0". The menu bar includes "File", "Edit", "Sketch", "Tools", and "Help". The toolbar shows icons for a checkmark, a right arrow, a play button, and a dropdown menu currently set to "Arduino Uno". The main editor area shows the code for "sketch_may1a.ino":

```
1 void setup() {  
2   // put your setup code here, to run once:  
3  
4 }  
5  
6 void loop() {  
7   // put your main code here, to run repeatedly:  
8  
9 }  
10
```

The status bar at the bottom right indicates "Ln 1, Col 1" and "Arduino Uno [not connected]".

Arduino

How to Set Up and Use the Arduino Software

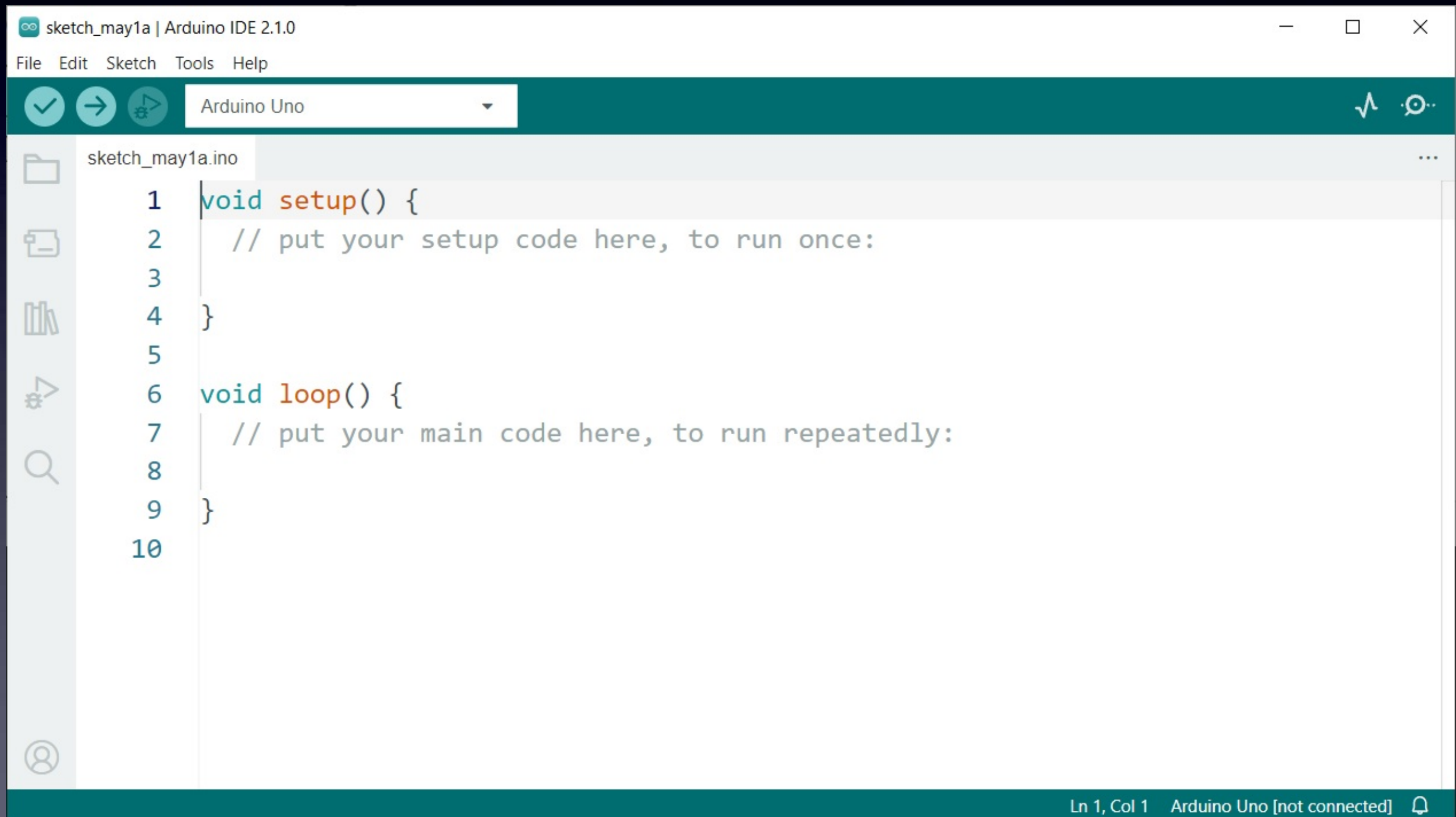

```
sketch_may1a.ino
1 void setup() {
2   // put your setup code here, to run once:
3
4 }
5
6 void loop() {
7   // put your main code here, to run repeatedly:
8
9 }
10
```

Ln 1, Col 1 Arduino Uno [not connected]

Arduino

The **first time** you start your Arduino software you need to do **two (or three) things** to set things up:

For Arduino Uno:

(1)

**Choose “Uno”
as the Board**

**(But,
if you have
a Nano board
then choose “Nano”)**

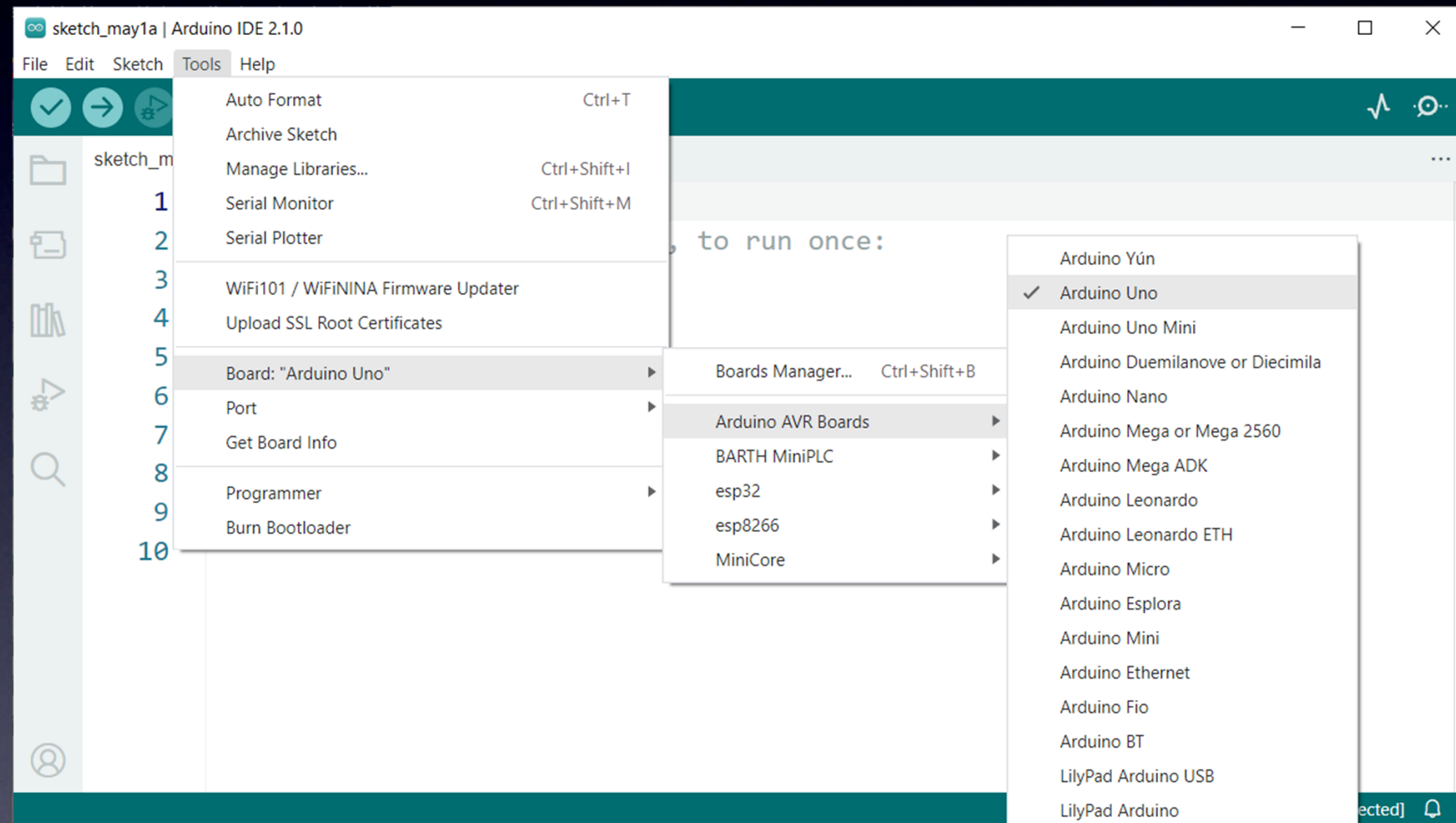

Arduino

The **first time** you start your Arduino software you need to do **two (or three) things** to set things up:

For Arduino Nano:
(1b)
Choose
your Processor

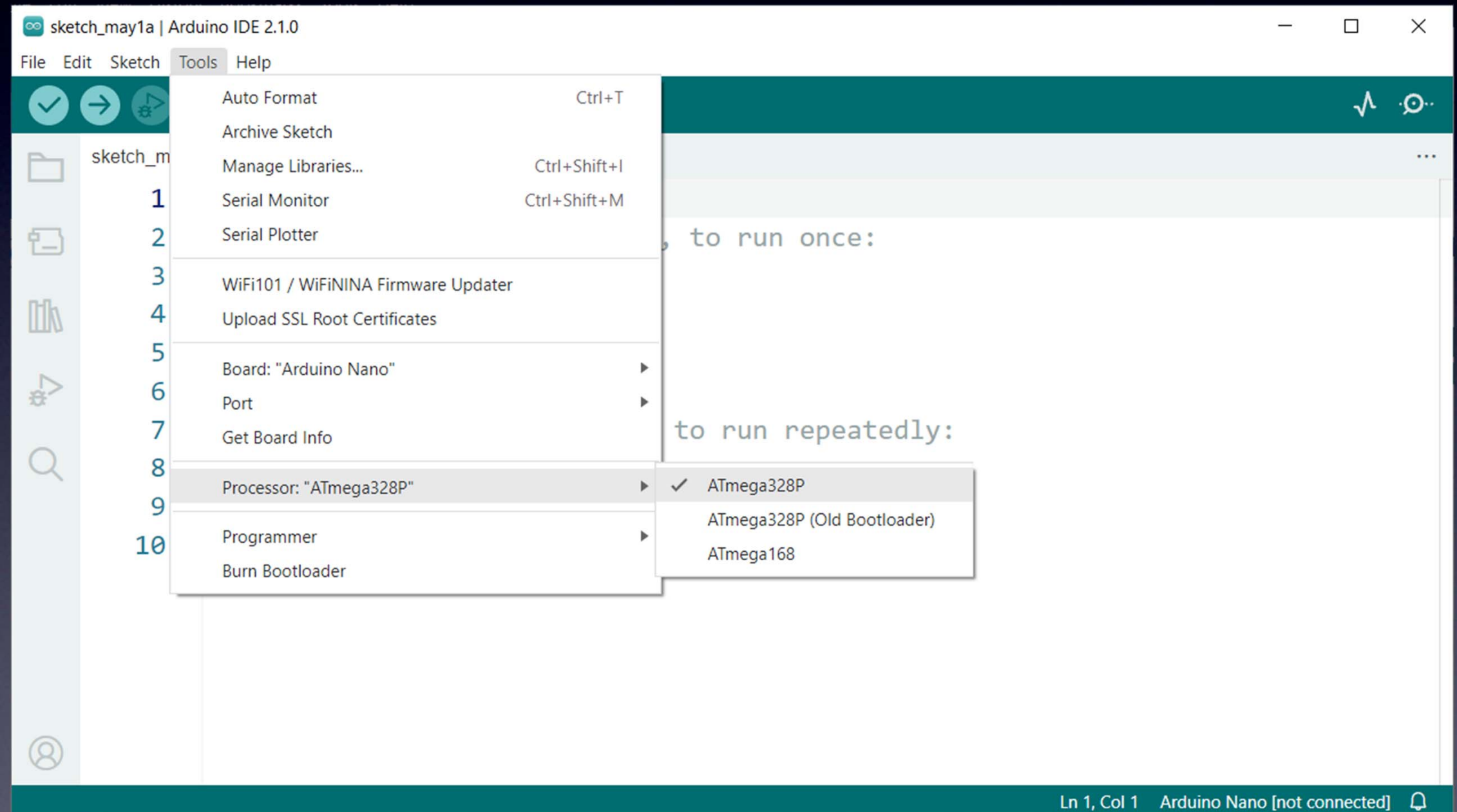

If this one doesn't work,
then
choose

“ATmega328P (Old Bootloader)”

Arduino

The **first time** you start your Arduino software you need to do **two (or three) things** to set things up:

(2)
Choose the Port
(this will be different depending on your Operating System)

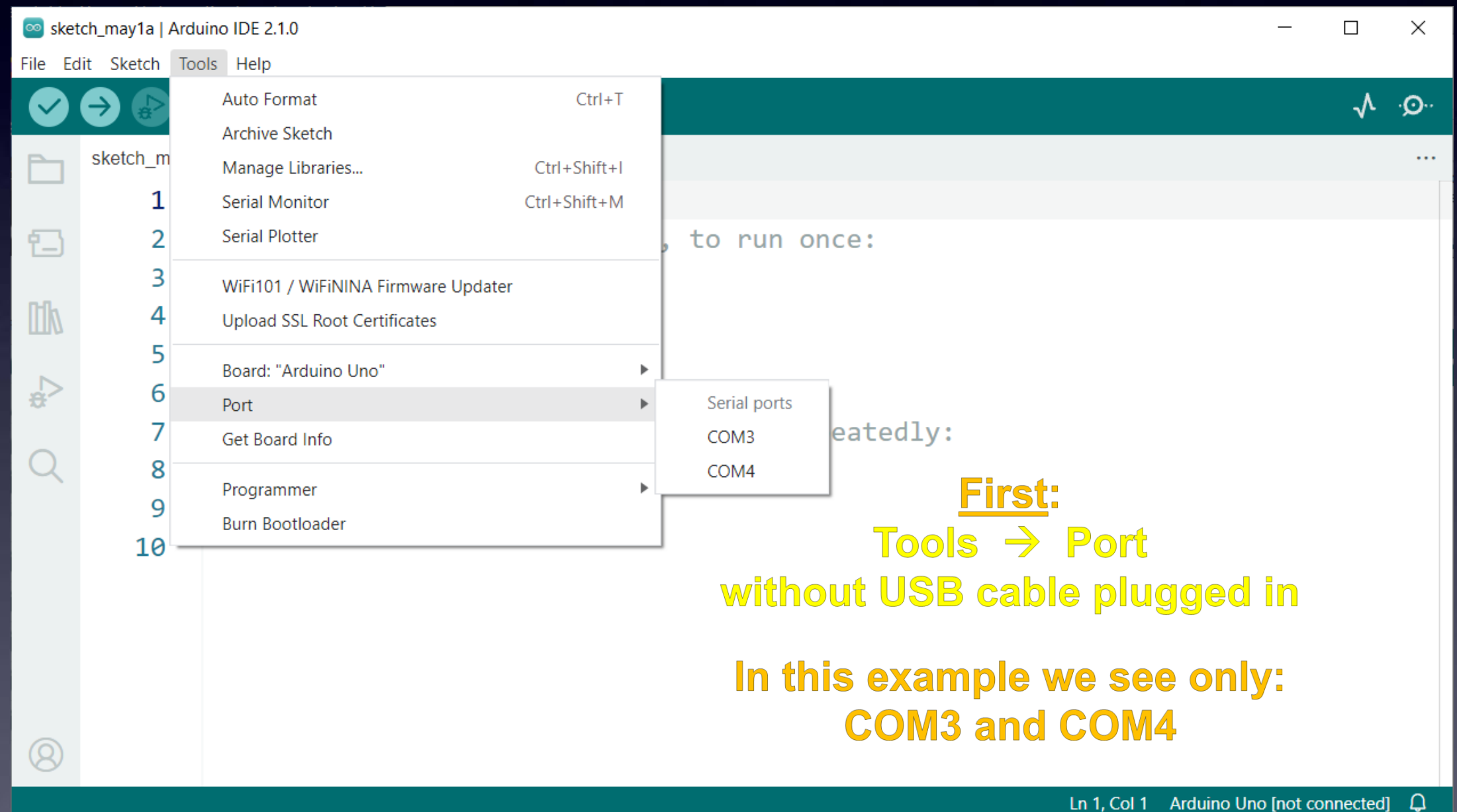

First:
Tools → Port
without USB cable plugged in

In this example we see only:
COM3 and COM4

Arduino

The **first time** you start your Arduino software you need to do **two (or three) things** to set things up:

(2)

Choose the Port (this will be different depending on your Operating System)

(After installing the driver for your USB-Serial cable, and plugging it in your operating system will see a serial port and it appears here.)

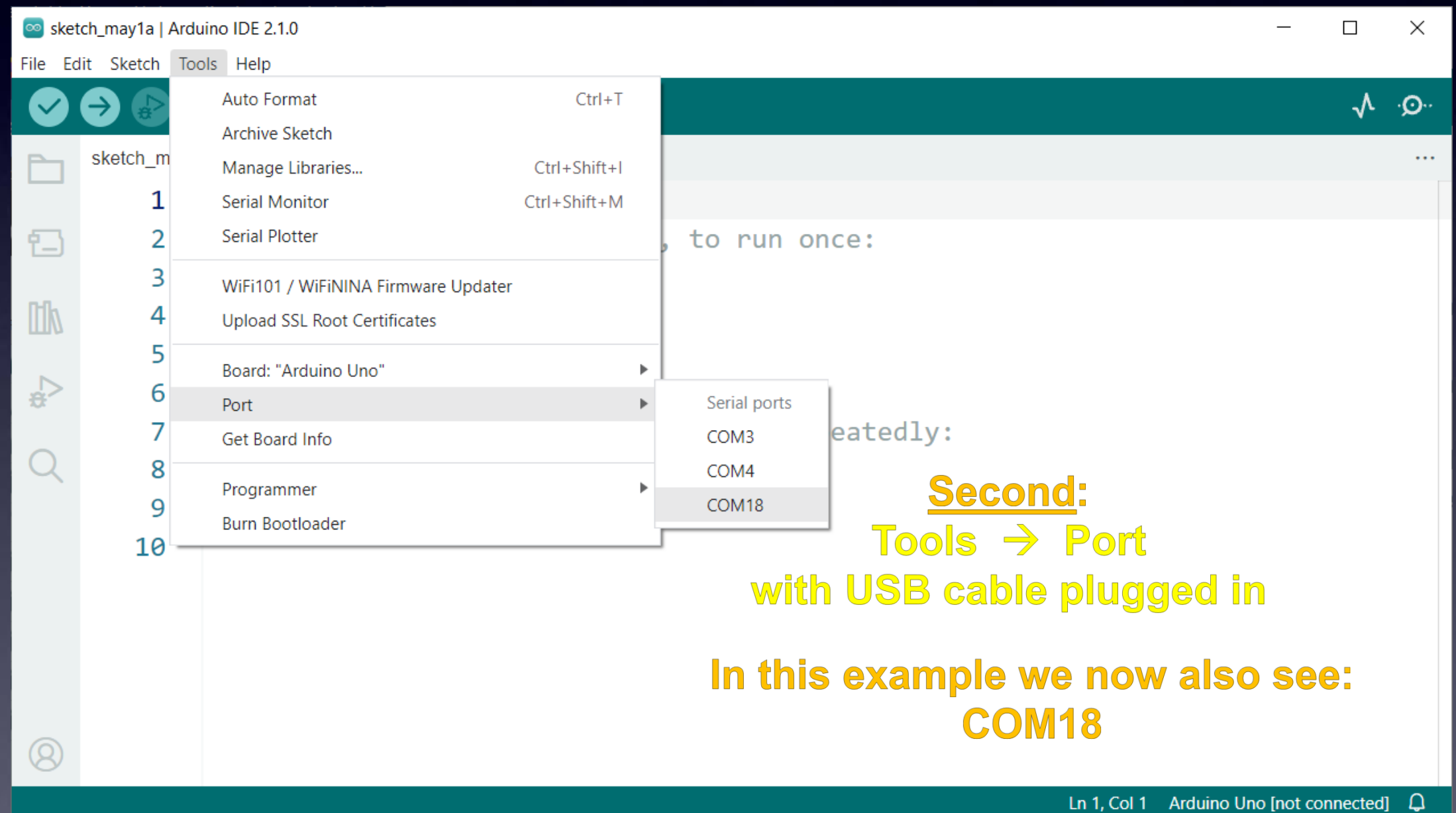

Second:
Tools → Port
with USB cable plugged in

In this example we now also see:
COM18

Choose the new port:
In this example: COM18

Arduino

Your Arduino software is now ready to program your Arduino board !

Your Arduino software is now ready

to program your
U-Do-It-Duino !

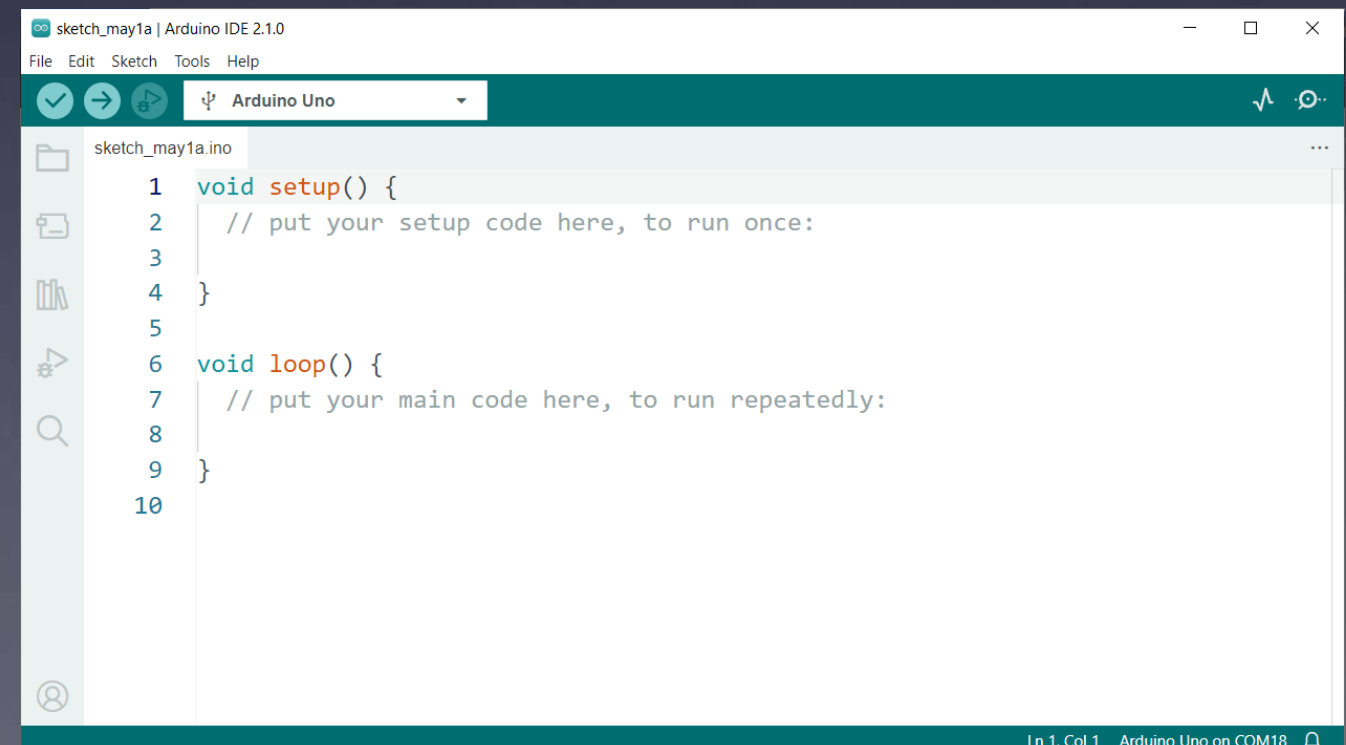

```
sketch_may1a.ino
1 void setup() {
2   // put your setup code here, to run once:
3
4 }
5
6 void loop() {
7   // put your main code here, to run repeatedly:
8
9 }
10
```

Arduino

Designed for non-geeky artists

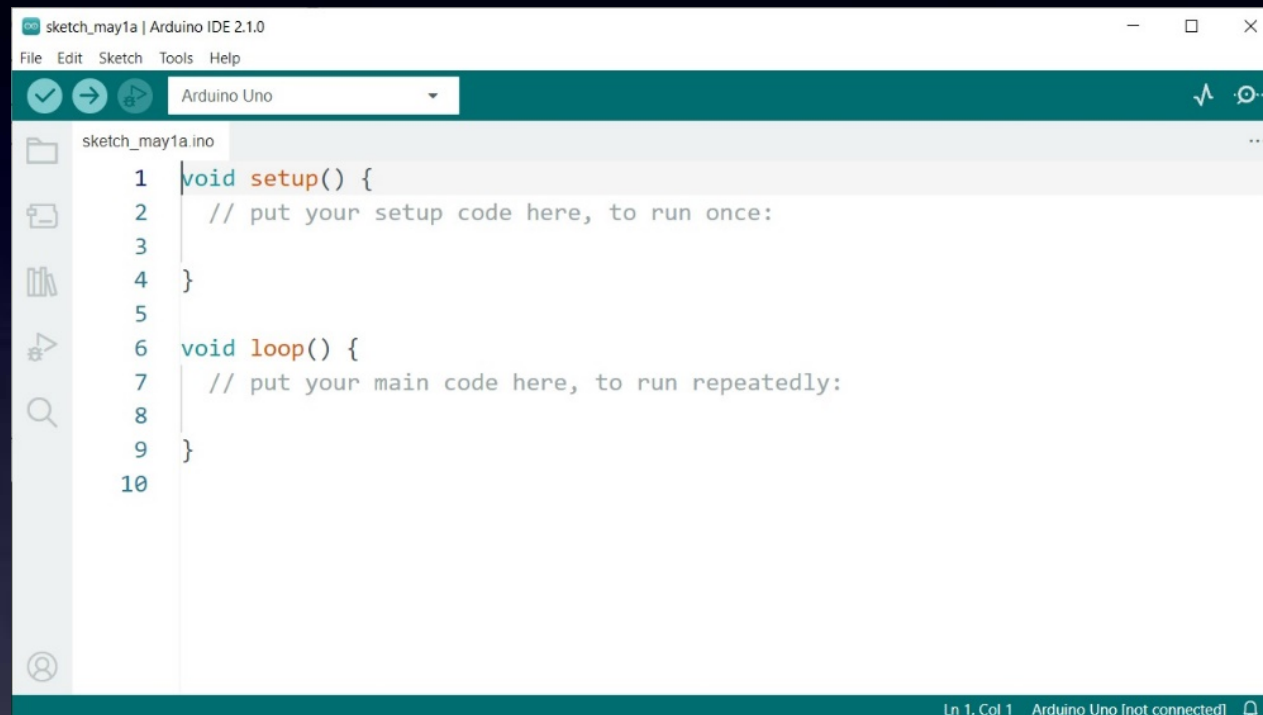

```
sketch_may1a.ino
1 void setup() {
2   // put your setup code here, to run once:
3
4 }
5
6 void loop() {
7   // put your main code here, to run repeatedly:
8
9 }
10
```

Ln 1, Col 1 Arduino Uno [not connected]

“Sketch” :
an Arduino program

Arduino

Designed for non-geeky artists

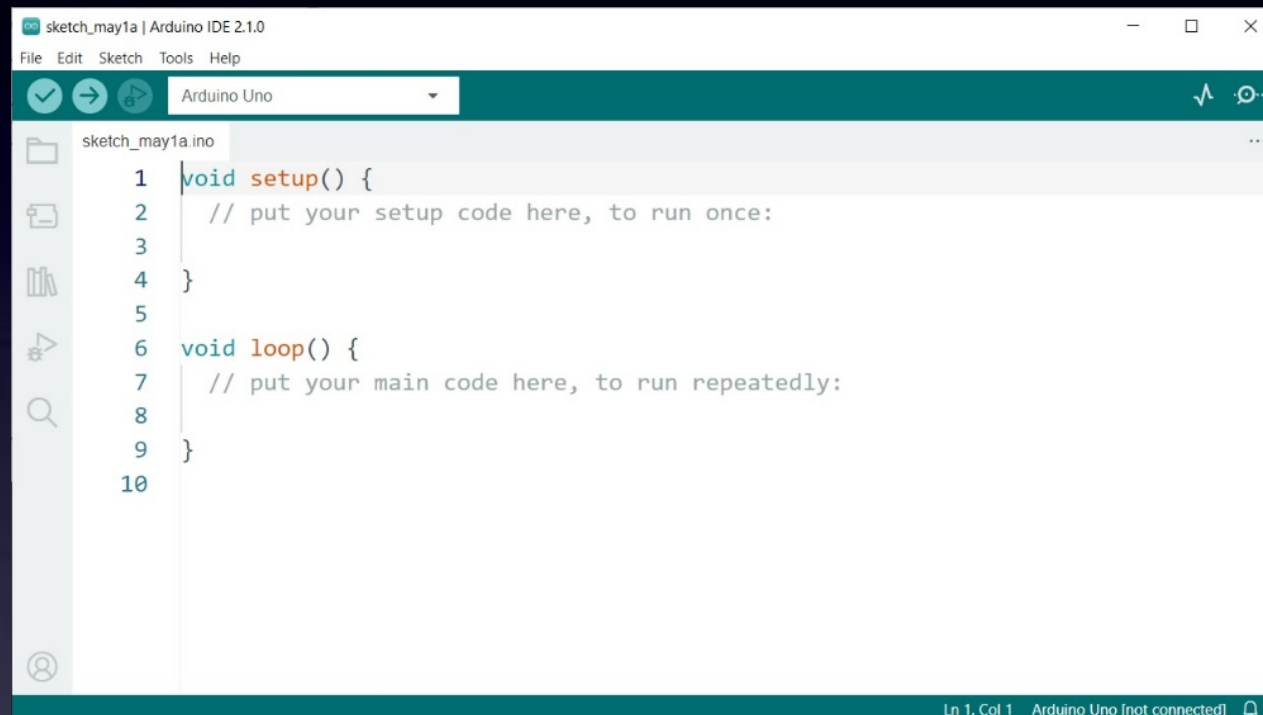

```
1 void setup() {  
2   // put your setup code here, to run once:  
3  
4 }  
5  
6 void loop() {  
7   // put your main code here, to run repeatedly:  
8  
9 }  
10
```

The Arduino language :

“Wiring”

(actually C/C++)

Arduino

Your Arduino software is now ready to program your Arduino board !

Let's make an LED blink! Hello World

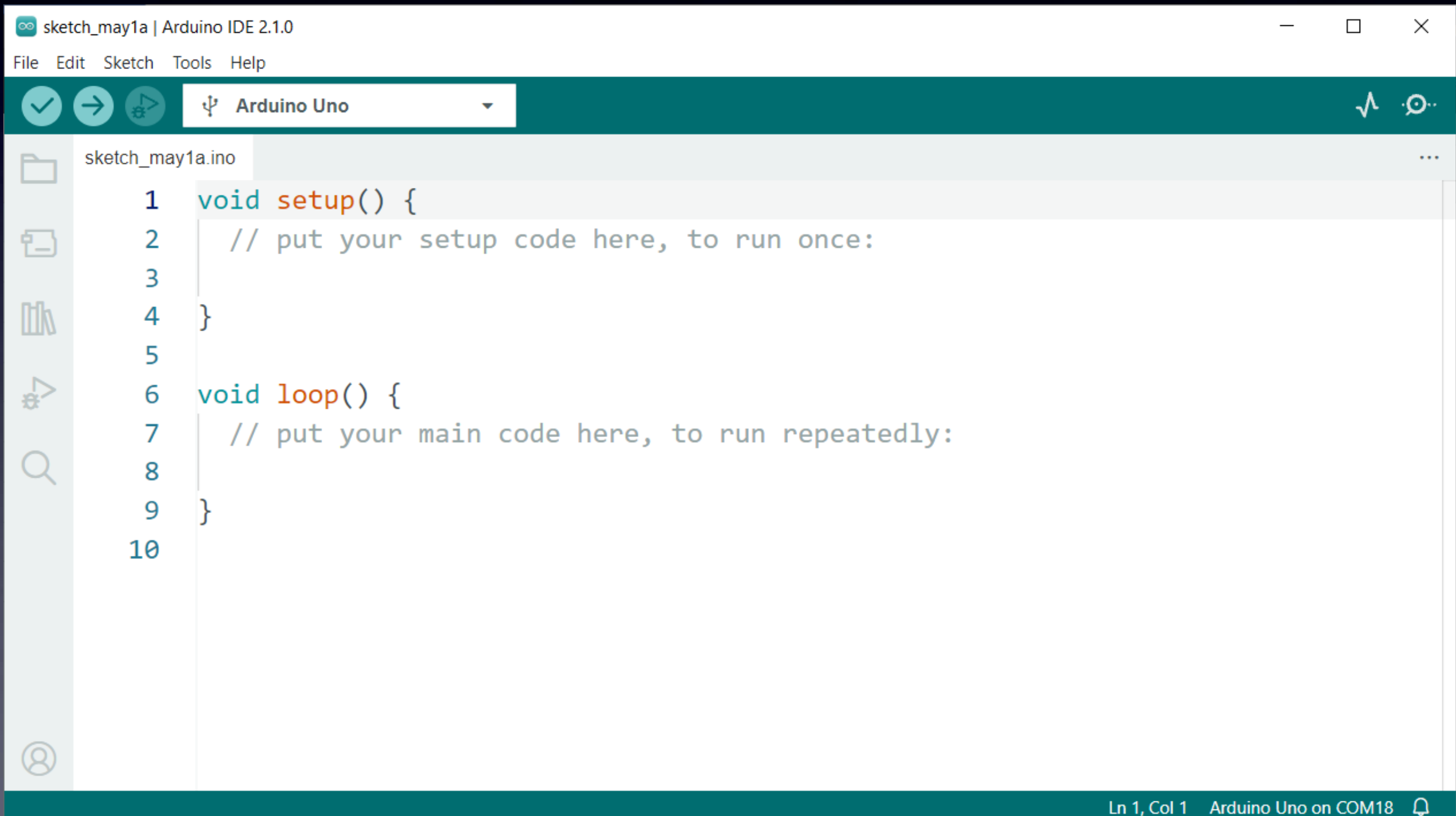

```
sketch_may1a | Arduino IDE 2.1.0
File Edit Sketch Tools Help
Arduino Uno
sketch_may1a.ino
1 void setup() {
2   // put your setup code here, to run once:
3
4 }
5
6 void loop() {
7   // put your main code here, to run repeatedly:
8
9 }
10
Ln 1, Col 1 Arduino Uno on COM18
```

Arduino

Your Arduino software is now ready to program your Arduino board !

Let's make an LED blink! Hello World

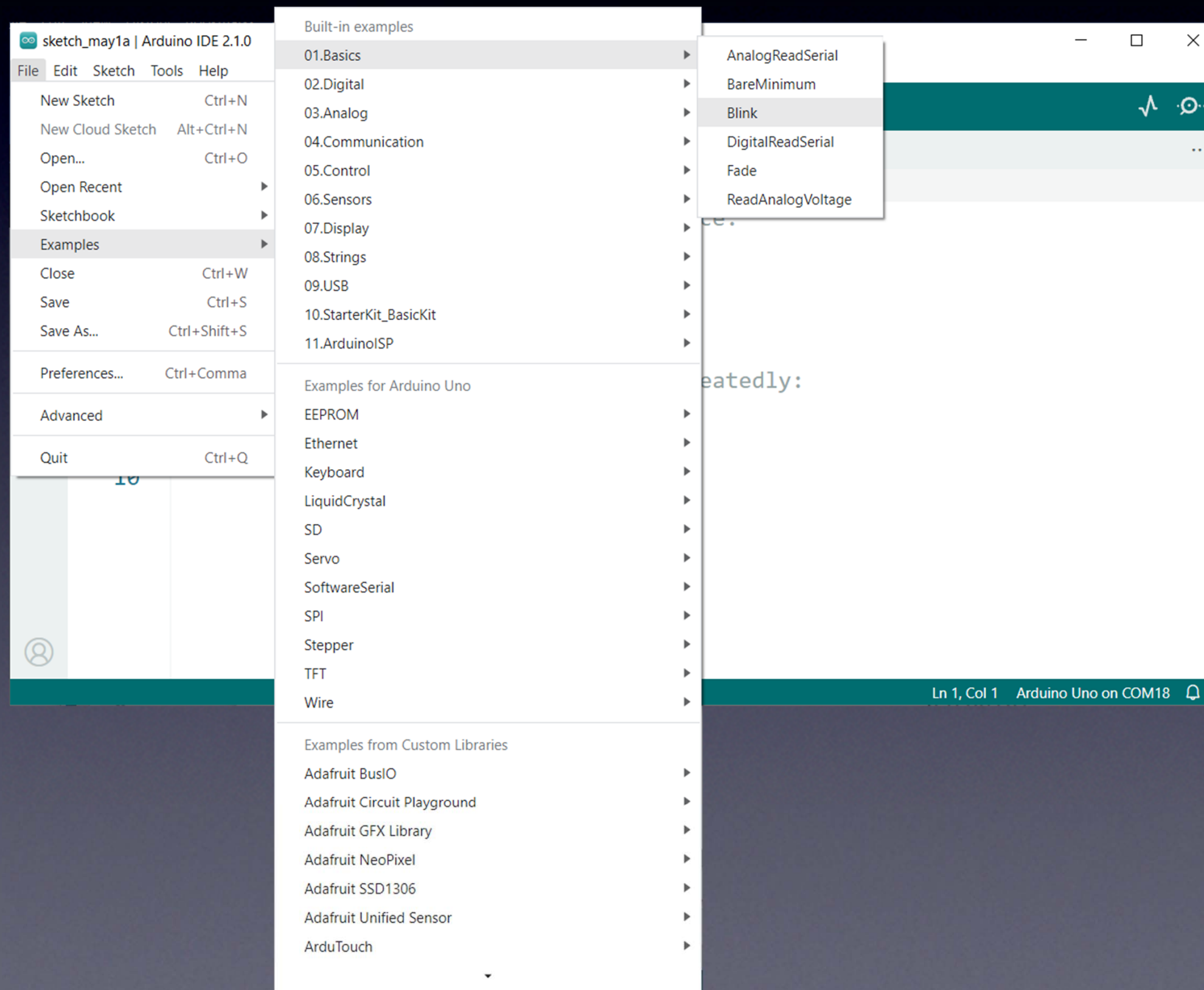

Arduino

Let's make an LED blink! Hello World

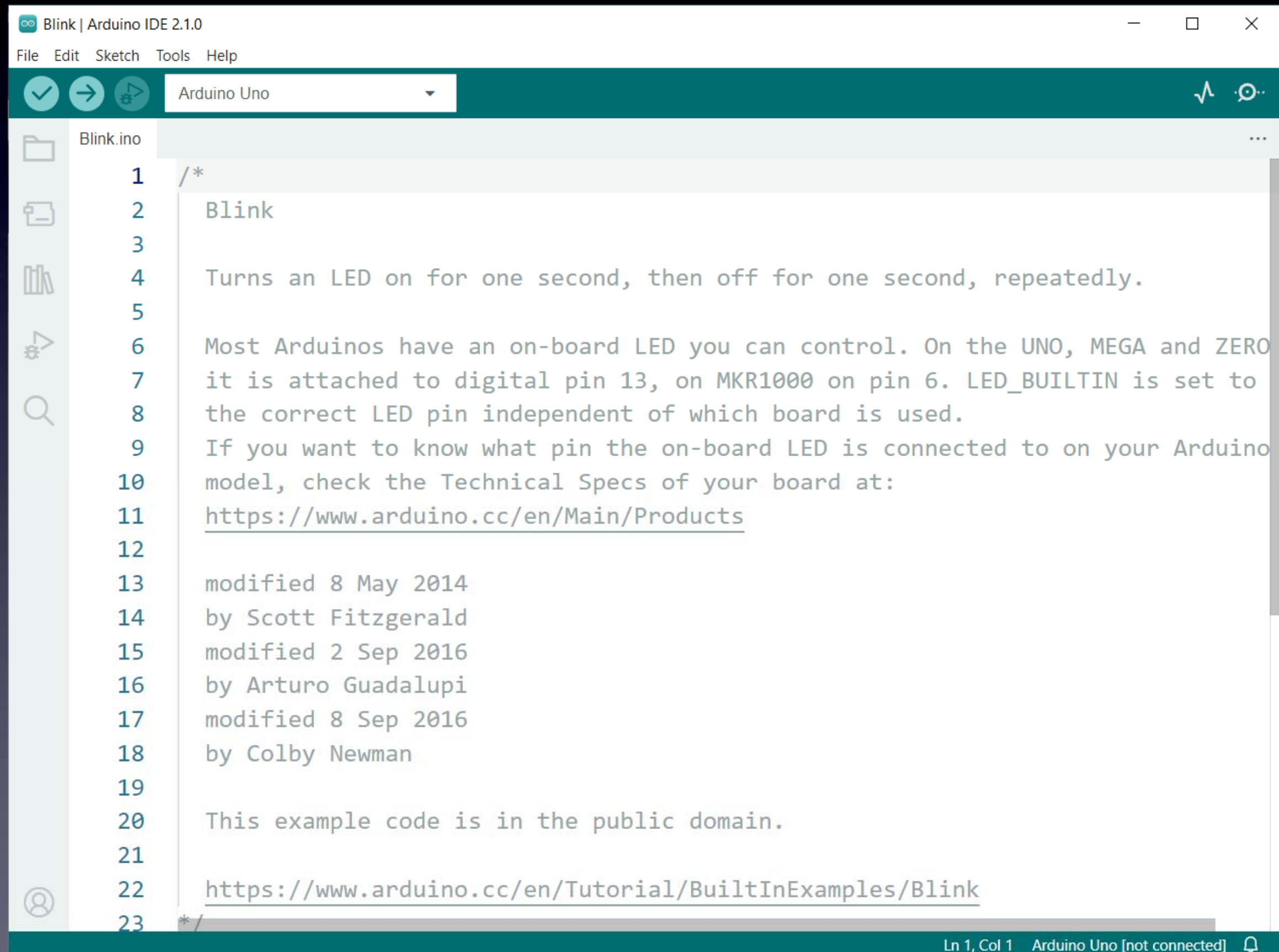

```
Blink | Arduino IDE 2.1.0
File Edit Sketch Tools Help
Arduino Uno
Blink.ino
1  /*
2  Blink
3
4  Turns an LED on for one second, then off for one second, repeatedly.
5
6  Most Arduinos have an on-board LED you can control. On the UNO, MEGA and ZERO
7  it is attached to digital pin 13, on MKR1000 on pin 6. LED_BUILTIN is set to
8  the correct LED pin independent of which board is used.
9  If you want to know what pin the on-board LED is connected to on your Arduino
10 model, check the Technical Specs of your board at:
11 https://www.arduino.cc/en/Main/Products
12
13 modified 8 May 2014
14 by Scott Fitzgerald
15 modified 2 Sep 2016
16 by Arturo Guadalupi
17 modified 8 Sep 2016
18 by Colby Newman
19
20 This example code is in the public domain.
21
22 https://www.arduino.cc/en/Tutorial/BuiltInExamples/Blink
23 */
Ln 1, Col 1 Arduino Uno [not connected]
```

Arduino

Let's make an LED blink! Hello World

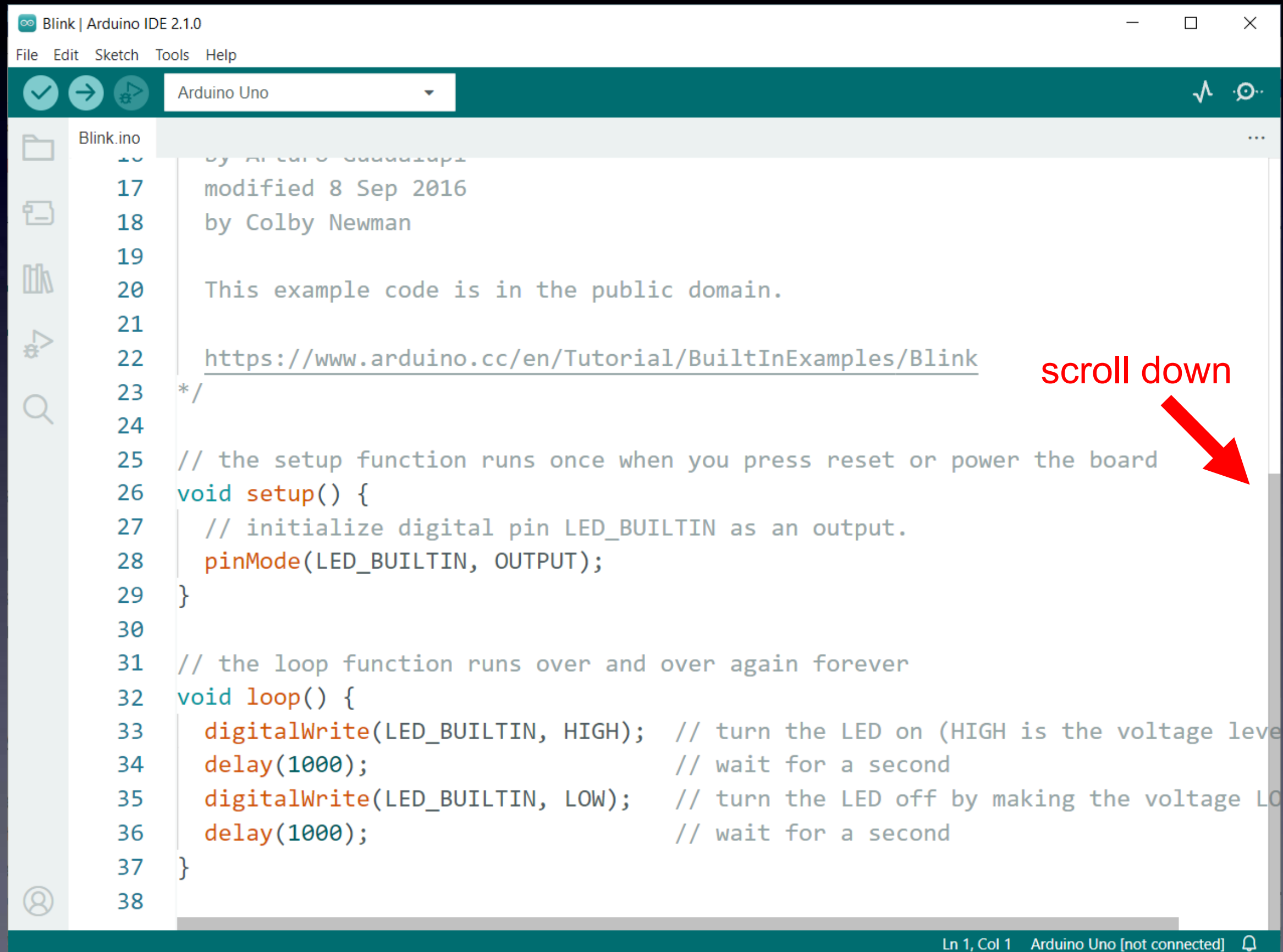

```
Blink | Arduino IDE 2.1.0
File Edit Sketch Tools Help
Arduino Uno
Blink.ino
16 by Arduino
17 modified 8 Sep 2016
18 by Colby Newman
19
20 This example code is in the public domain.
21
22 https://www.arduino.cc/en/Tutorial/BuiltInExamples/Blink
23 */
24
25 // the setup function runs once when you press reset or power the board
26 void setup() {
27   // initialize digital pin LED_BUILTIN as an output.
28   pinMode(LED_BUILTIN, OUTPUT);
29 }
30
31 // the loop function runs over and over again forever
32 void loop() {
33   digitalWrite(LED_BUILTIN, HIGH); // turn the LED on (HIGH is the voltage level)
34   delay(1000); // wait for a second
35   digitalWrite(LED_BUILTIN, LOW); // turn the LED off by making the voltage LOW
36   delay(1000); // wait for a second
37 }
38
```

scroll down

Ln 1, Col 1 Arduino Uno [not connected]

Arduino

With the USB-Serial cable connected to your ArduTouch board press the Upload button

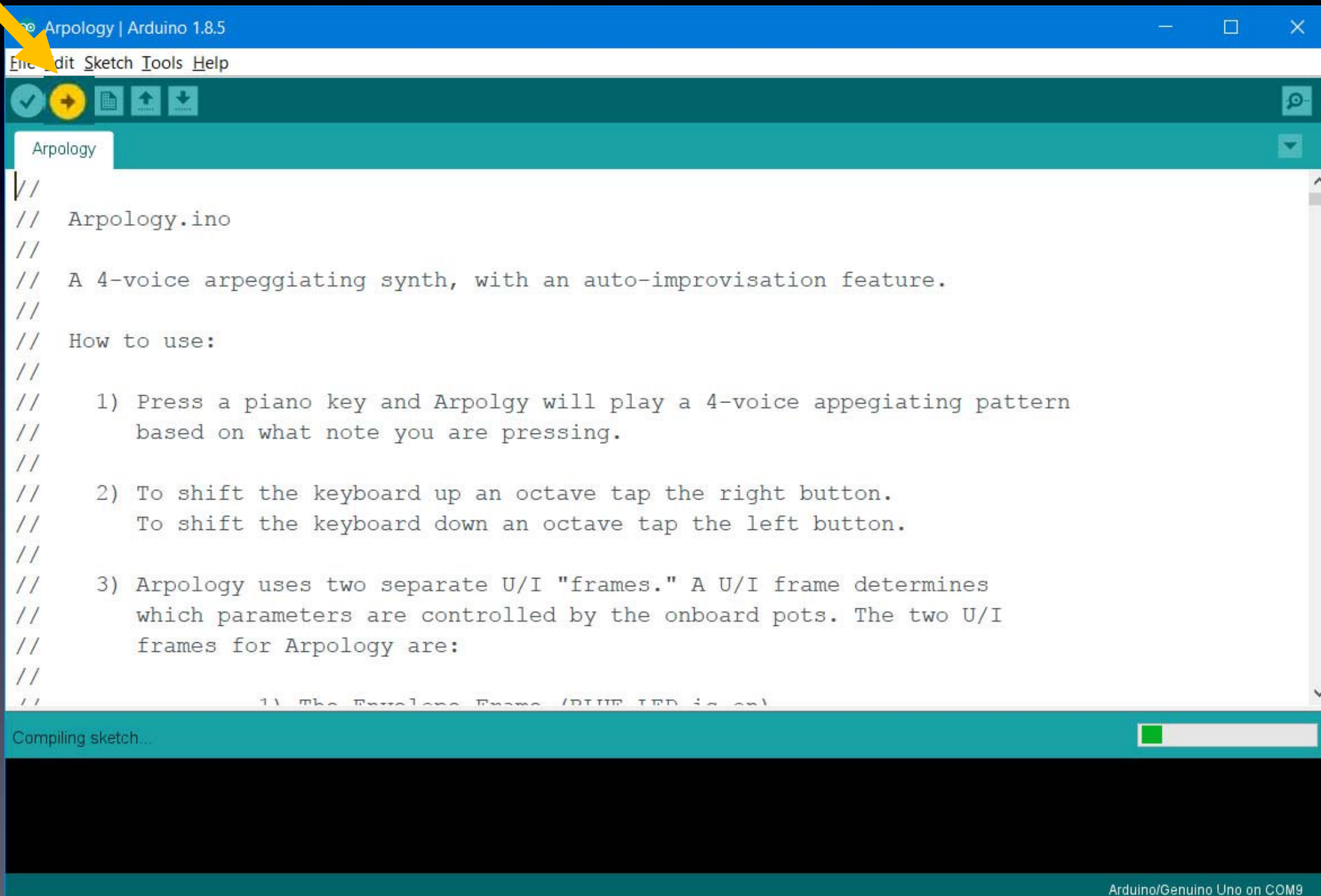

```
Arpology | Arduino 1.8.5
File Edit Sketch Tools Help
Arpology
//
//  Arpology.ino
//
//  A 4-voice arpeggiating synth, with an auto-improvisation feature.
//
//  How to use:
//
//  1) Press a piano key and Arpology will play a 4-voice arpeggiating pattern
//     based on what note you are pressing.
//
//  2) To shift the keyboard up an octave tap the right button.
//     To shift the keyboard down an octave tap the left button.
//
//  3) Arpology uses two separate U/I "frames." A U/I frame determines
//     which parameters are controlled by the onboard pots. The two U/I
//     frames for Arpology are:
//
//     1) The Envelope Frame (BLUE LED is on)
```

Compiling sketch...

Arduino/Genuino Uno on COM9

Arduino

While uploading, you will see a progress bar...

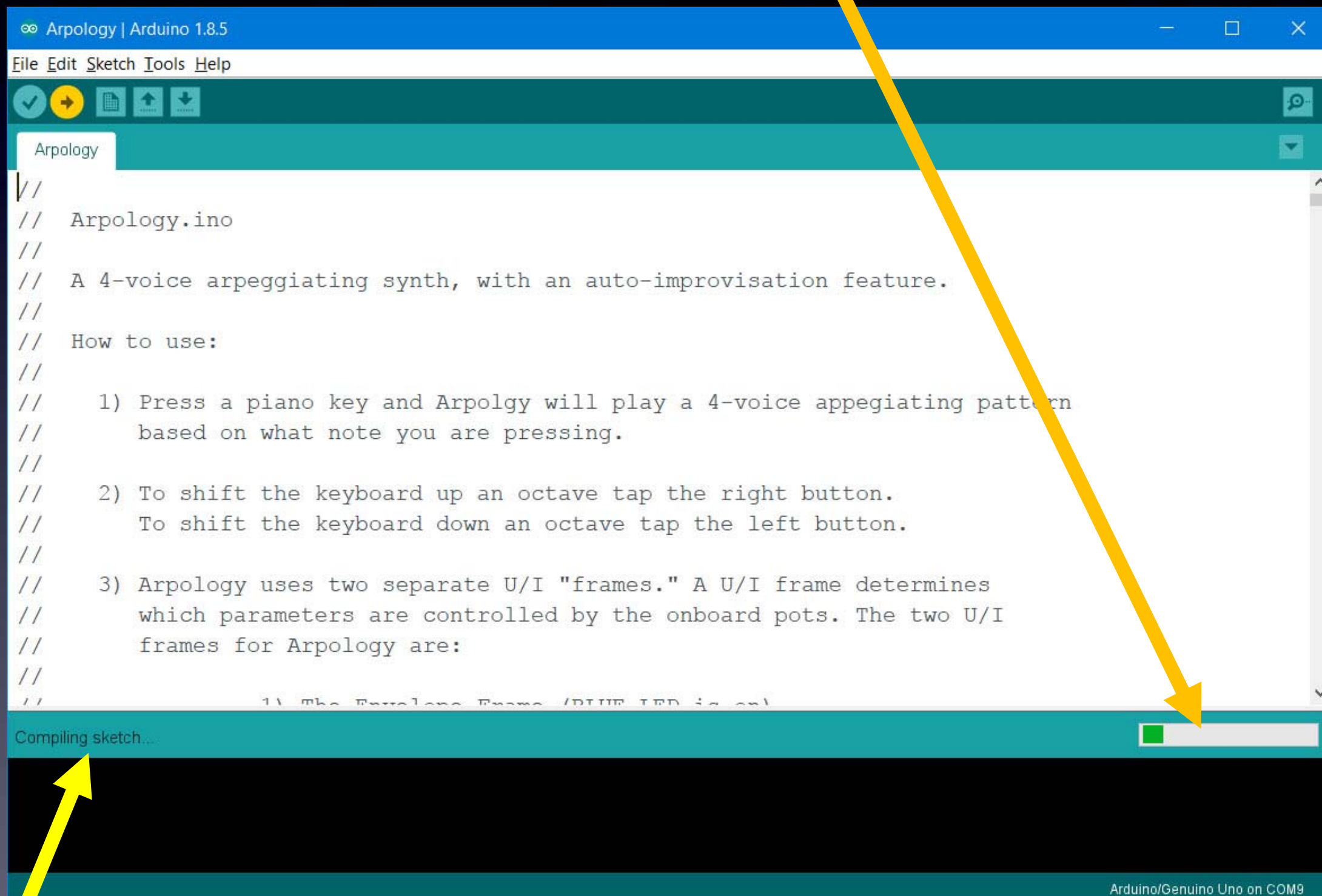

...and when it's completed successfully, it says: "Upload done"

How to Hack Arduino Programs (“Sketches”)

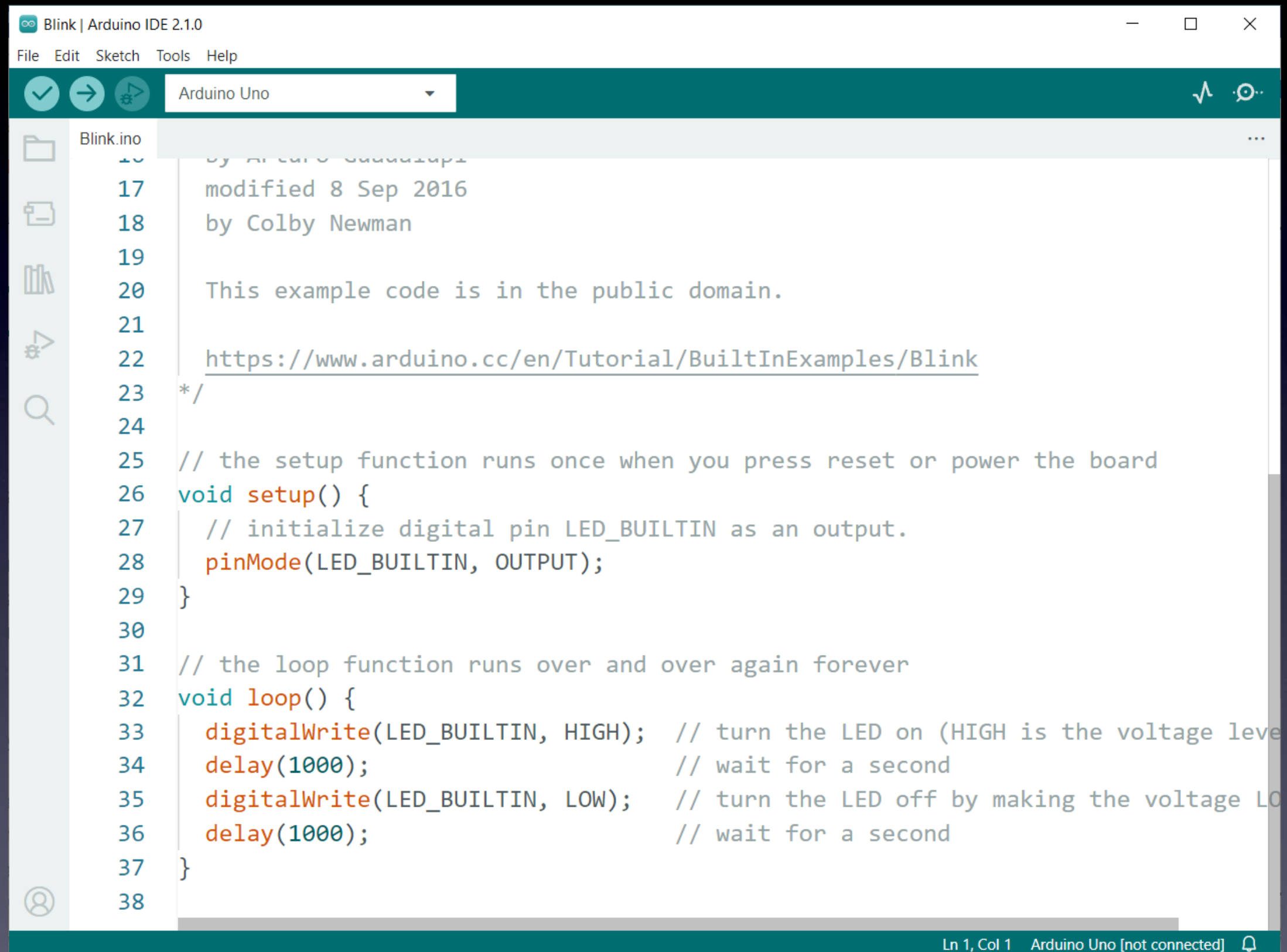

```
Blink | Arduino IDE 2.1.0
File Edit Sketch Tools Help
Arduino Uno
Blink.ino
17  by Arduino Suddutip
18  modified 8 Sep 2016
19  by Colby Newman
20  This example code is in the public domain.
21
22  https://www.arduino.cc/en/Tutorial/BuiltInExamples/Blink
23  */
24
25  // the setup function runs once when you press reset or power the board
26  void setup() {
27    // initialize digital pin LED_BUILTIN as an output.
28    pinMode(LED_BUILTIN, OUTPUT);
29  }
30
31  // the loop function runs over and over again forever
32  void loop() {
33    digitalWrite(LED_BUILTIN, HIGH); // turn the LED on (HIGH is the voltage level)
34    delay(1000); // wait for a second
35    digitalWrite(LED_BUILTIN, LOW); // turn the LED off by making the voltage LOW
36    delay(1000); // wait for a second
37  }
38
```

Ln 1, Col 1 Arduino Uno [not connected]

How to Hack Arduino Programs (“Sketches”)

Many ways!

Here are just a few:

- Change blink rates
- External LED
- External motor
- External speaker
- External LED on Solderless breadboard
- More complex projects on Solderless breadboard

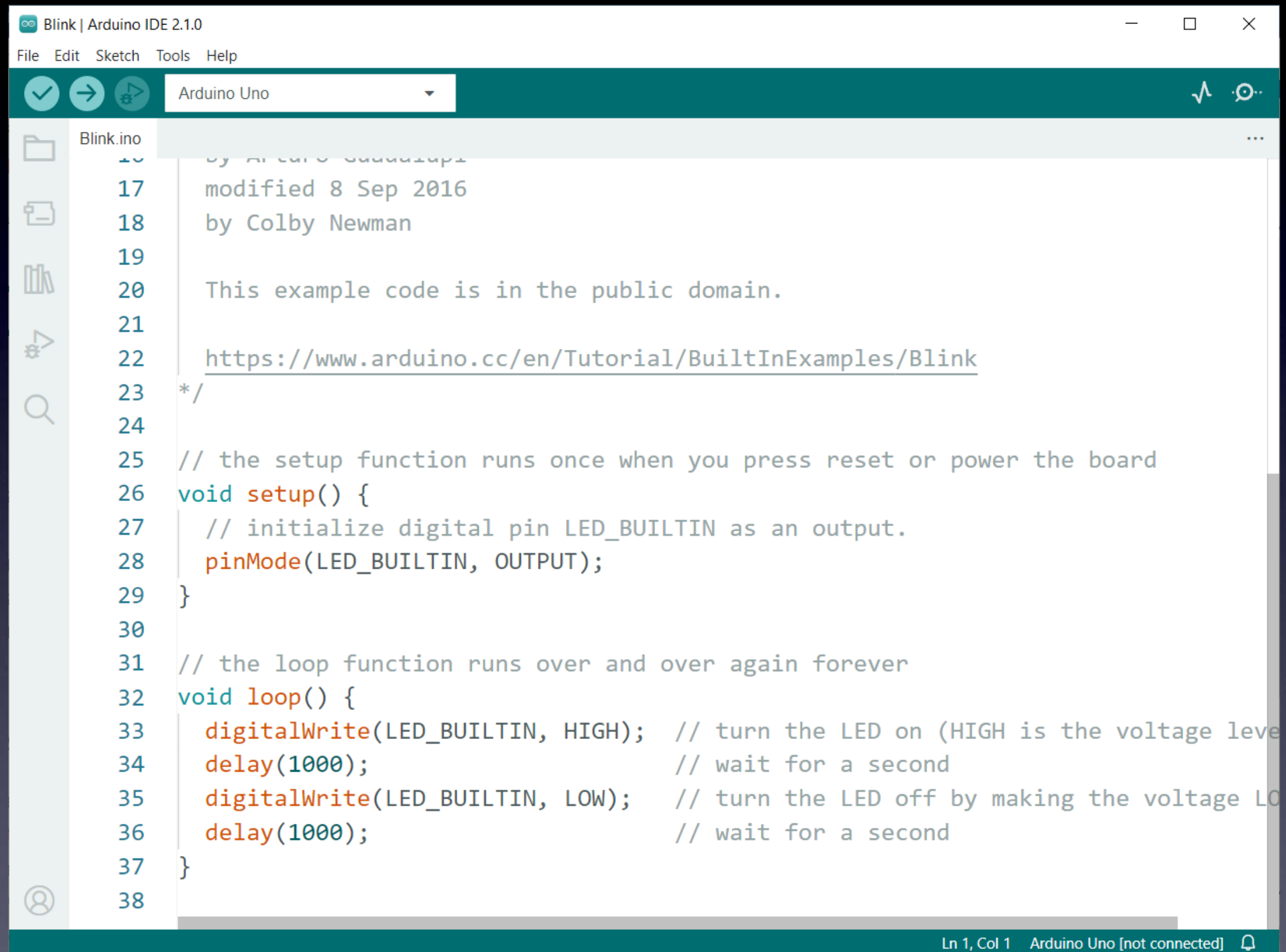

```
Blink | Arduino IDE 2.1.0
File Edit Sketch Tools Help
Arduino Uno
Blink.ino
16 by Arduino Staff
17 modified 8 Sep 2016
18 by Colby Newman
19
20 This example code is in the public domain.
21
22 https://www.arduino.cc/en/Tutorial/BuiltInExamples/Blink
23 */
24
25 // the setup function runs once when you press reset or power the board
26 void setup() {
27   // initialize digital pin LED_BUILTIN as an output.
28   pinMode(LED_BUILTIN, OUTPUT);
29 }
30
31 // the loop function runs over and over again forever
32 void loop() {
33   digitalWrite(LED_BUILTIN, HIGH); // turn the LED on (HIGH is the voltage level)
34   delay(1000); // wait for a second
35   digitalWrite(LED_BUILTIN, LOW); // turn the LED off by making the voltage LOW
36   delay(1000); // wait for a second
37 }
38
Ln 1, Col 1 Arduino Uno [not connected]
```

How to Hack Arduino Programs (“Sketches”)



How to Hack Arduino Programs (“Sketches”)

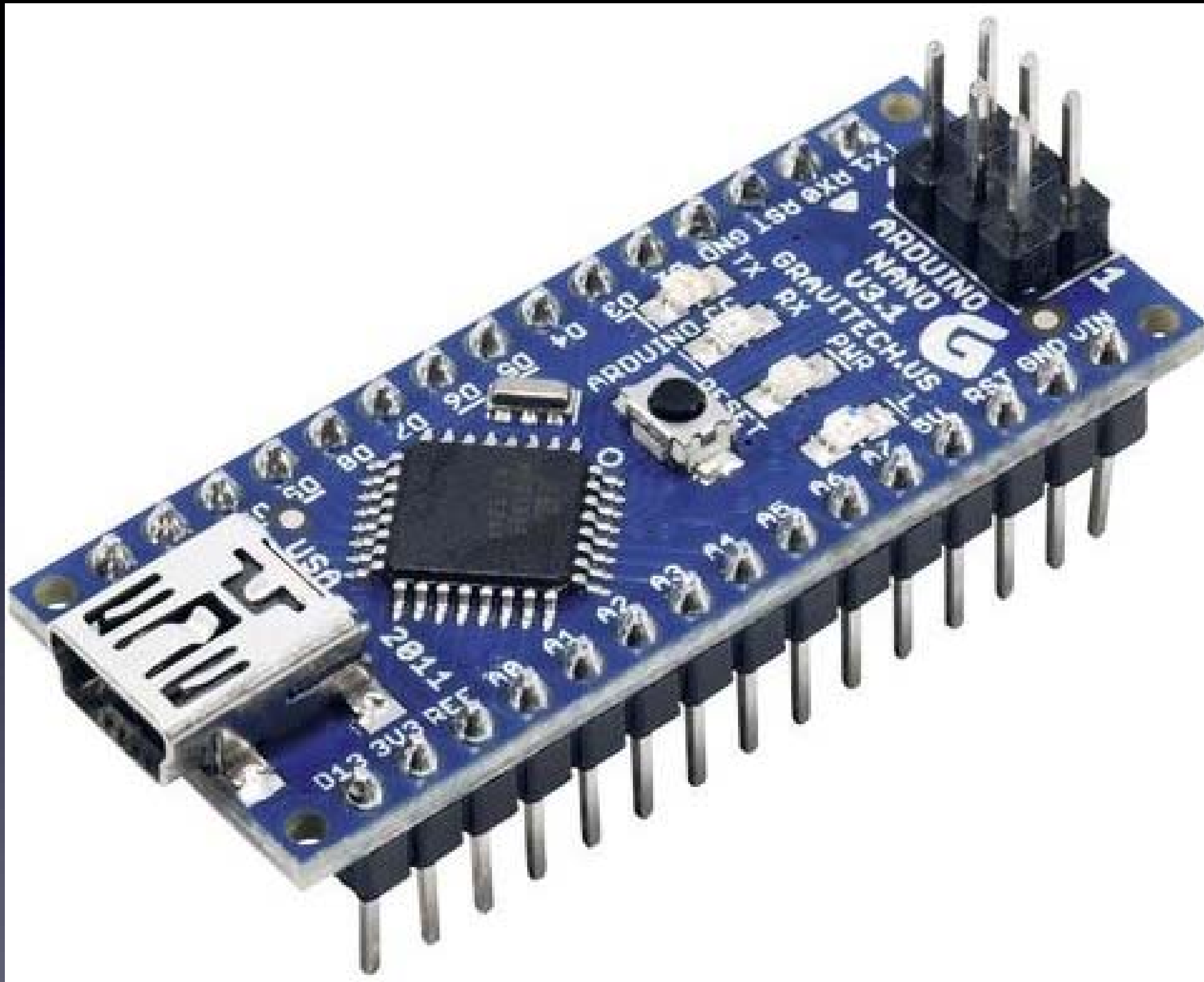

How to Use Solderless Breadboards

Solderless Breadboard

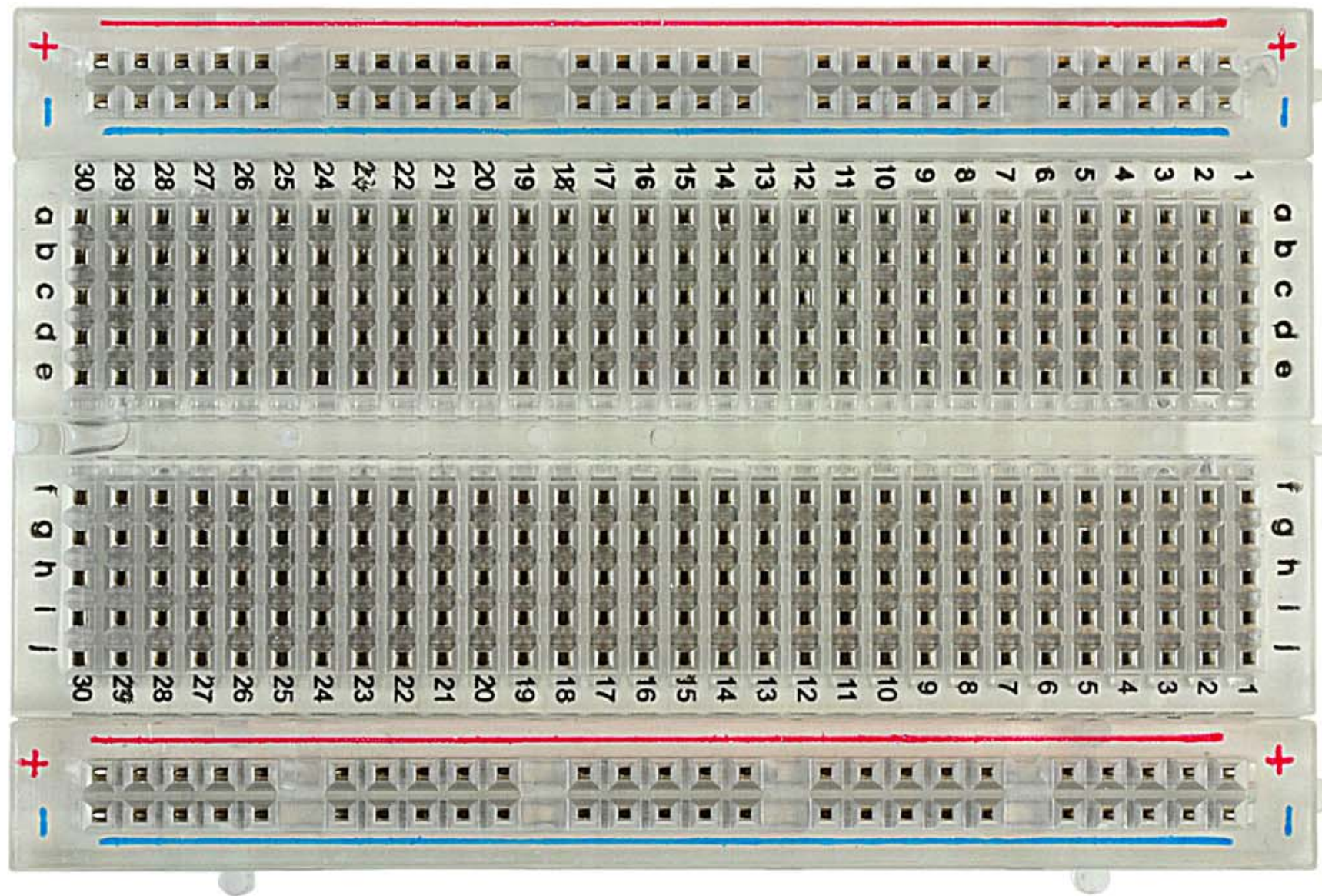

How to Use Solderless Breadboards

Solderless Breadboard with LED

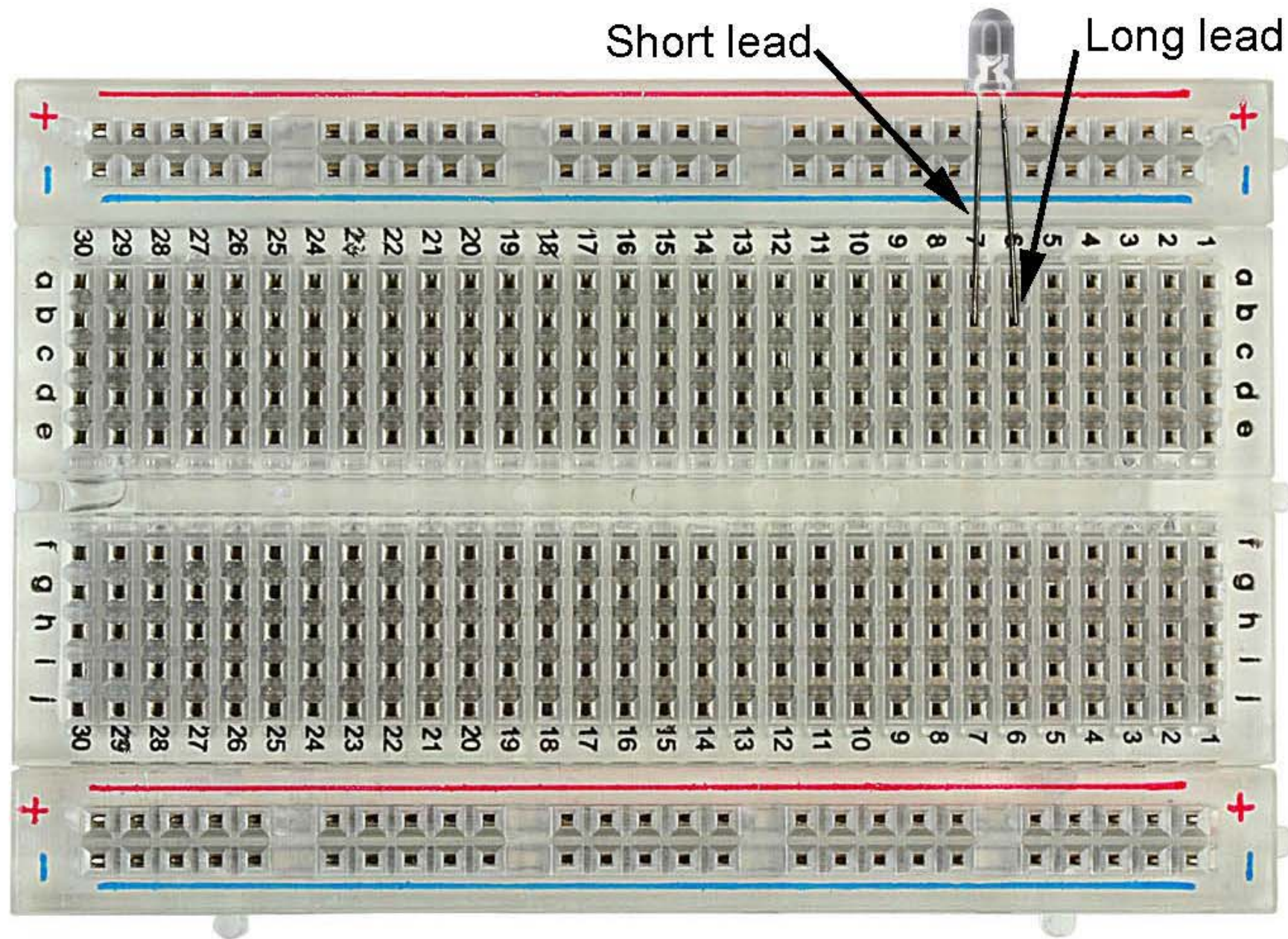

How to Use Solderless Breadboards

Solderless Breadboard with LED and wires

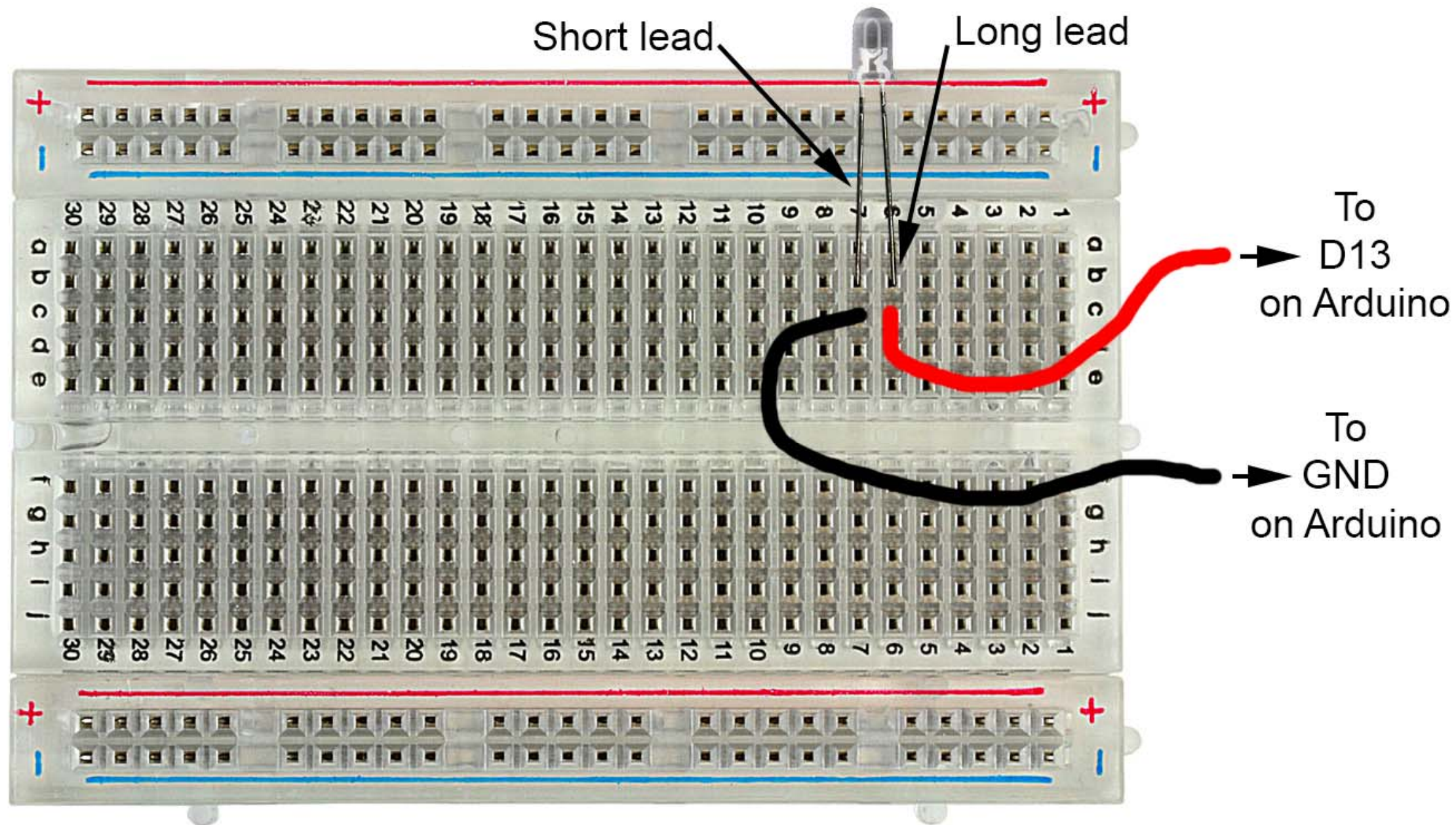

How to Use Solderless Breadboards

Solderless Breadboard with LED and Resistor and wires

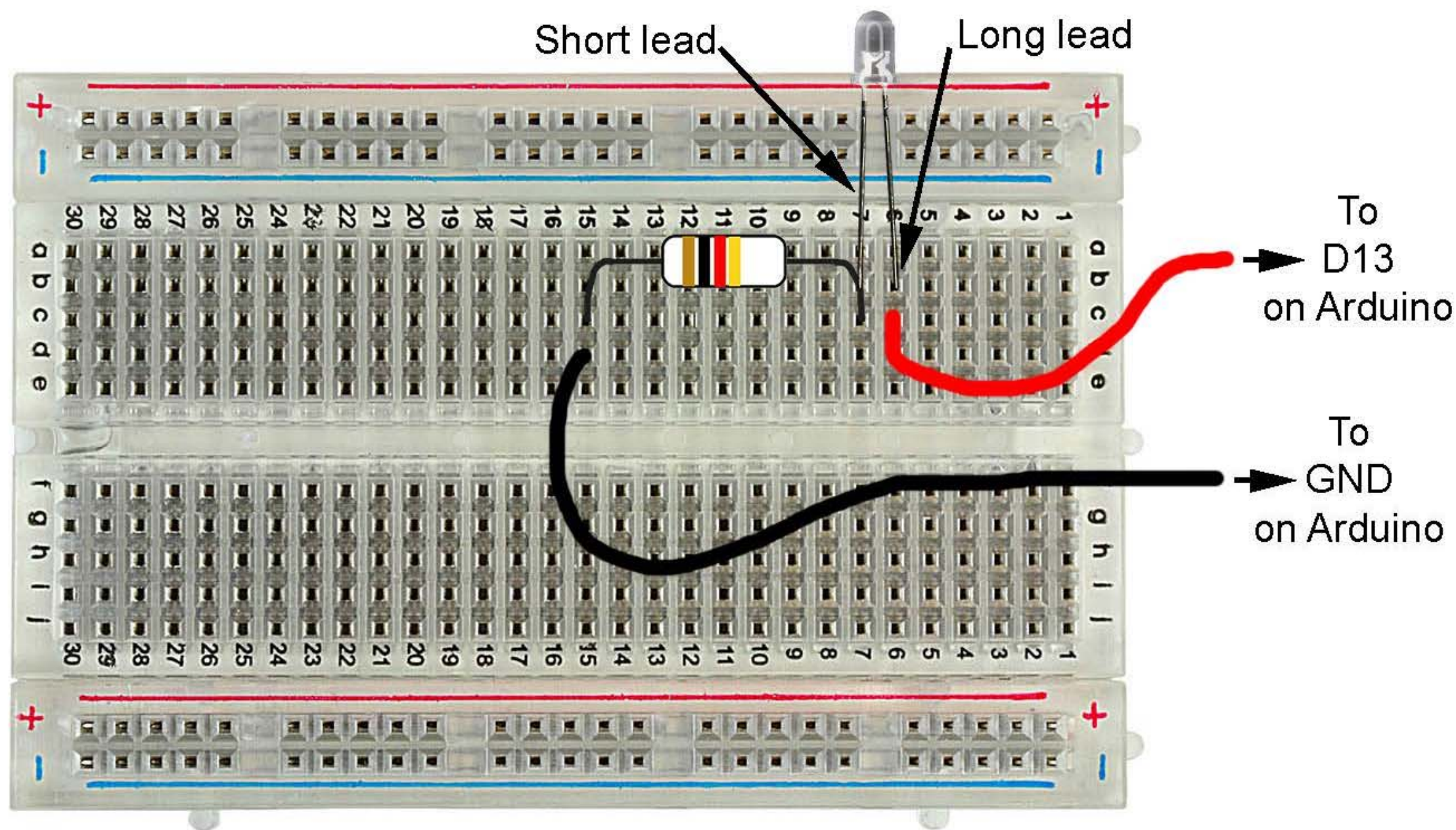

How to Read a Schematic

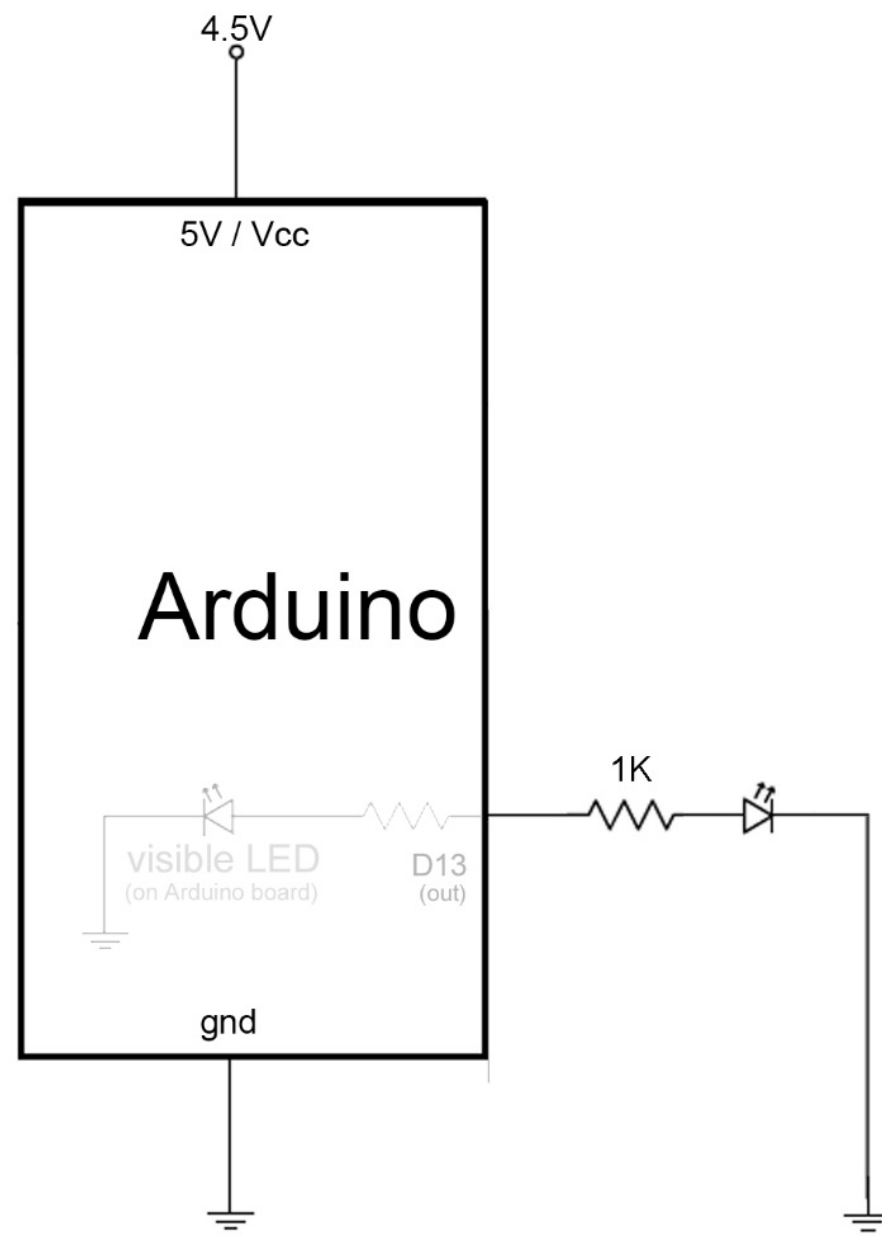

How to Read a Schematic

Arduino For Total Newbies

4-Sep-2015

Mitch Altman (original TV-B-Gone hardware and firmware, modified TV-B-Gone Arduino design)
Limore Fried (firmware modifications, kit design)
Ken Shirriff (original modifications for Arduino)
Johannes Schneemann (documentation)

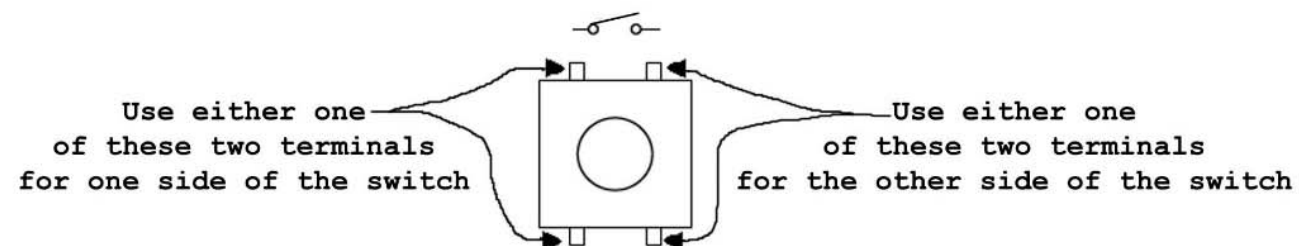
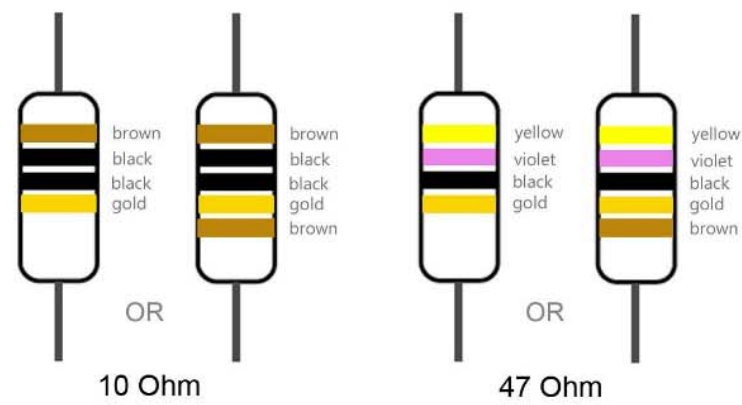
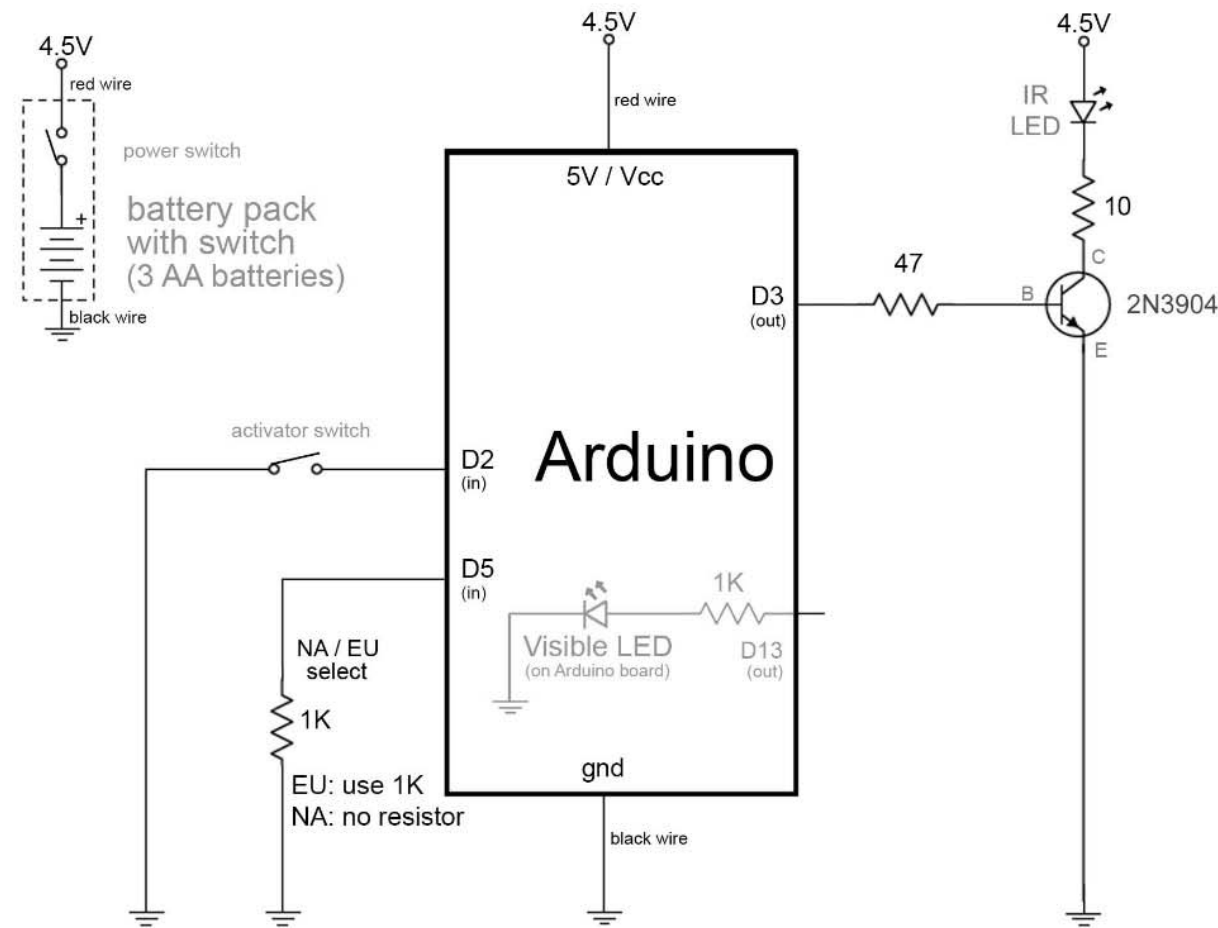

Parts Pack Contents

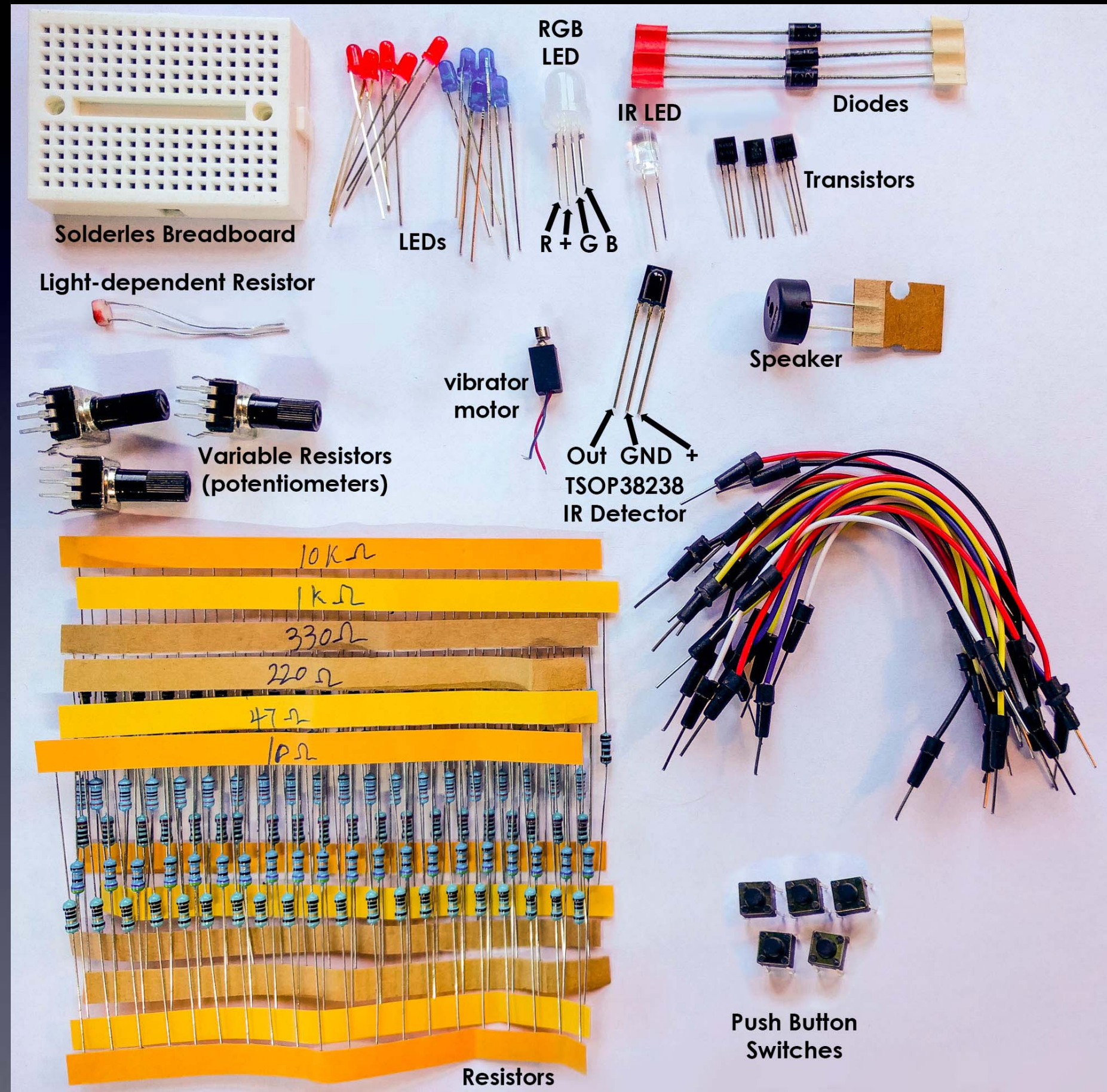

To Download these slides

see the

Arduno for(4) Total Newbies

workshop web-page:

<https://tinyurl.com/A4TNworkshop>

Arduino For Total Newbies

w/ TV-B-Gone as example project

Mitch Altman

Chief Scientist, **Cornfield Electronics**, San Francisco, CA
Inventor of **TV-B-Gone** universal remote controls
Co-founder of **3Ware** (successful Silicon Valley startup)
Pioneer of **VR** (in the mid-1980s)
Founding mentor at **HAX** (1st and biggest hardware accelerator)
Co-founder of **Noisebridge** (San Francisco hackerspace)
email: mitch@CornfieldElectronics.com
site: www.CornfieldElectronics.com
facebook: maltman23
flickr: maltman23
WeChat: mitchaltman
Fediverse: @maltman23@mastodon.social
Patreon: mitchaltman

